



Product Catalog



POLICIES

Ordering Options

Three Easy Ways To Order

Phone

(877) 5-SUNSET (877-578-6738)

Our customer service professionals are here to assist you M-F 8:00 AM – 5:00 PM Central Time.

Fax

312-997-9985 — Accepted 24 hours a day.

Email

sales@sunsethcs.com

Payment Methods

Payment Portal and ACH

Visit www.sunsethcs.com/paymentportal to pay online with ACH or credit card.

Net 30-Day Payment Terms

For qualified companies. A 1.5% monthly finance charge will be assessed on all past due invoices.

COD

For non-qualified companies.

Credit Card

We accept all major credit cards. A processing fee may apply. After 10 days of invoice date, a surcharge of 2.5% will be applied.



Shipping

Drop shipping available — ask your sales rep about sending your order to multiple locations.

UPS

Whenever possible, orders ship via UPS. If another carrier is desired, please contact your sales rep.

All orders are packed in the smallest boxes available and combined with other products on the order to reduce shipping costs.

All products ship prepaid and are added to the invoice.

All products ship from Bloomingdale, IL or Oxnard, CA. Please refer to UPS.com for transit times.

Damaged Merchandise

Call us within 10 days. Keep original cartons for UPS inspection.

We proudly partner with



Customer Service

Returns

Call us for a return authorization number. There is no restocking charge on orders returned within 20 days of invoice. Orders returned after 20 days may be assessed a restocking fee of 15%. No returns after 90 days. (877) 5-SUNSET (877-578-6738)

Central Distribution Center

Sunset Healthcare Solutions
279 Madsen Dr Ste 101
Bloomingdale, IL 60108

Western Distribution Center

Sunset Healthcare Solutions
2450 Statham Blvd
Oxnard, CA 93033

Problems

Please call us immediately if you have any complaints (it is helpful to ask for the customer service representative with whom you placed your order).

Or email us at: customerservice@sunsethcs.com

Questions?

Our experienced customer service staff will be glad to provide you with information. Just give us a call.

Pricing

All prices are in U.S. Dollars.

Taxes are added where applicable.

We make every effort to hold pricing throughout the year. However, prices are subject to change without notice.

Contact us for more information on fulfillment and compliance solutions that best fit your needs.

CONTENT

CPAP

	Page
Masks and Replacement Parts	4-13
Sunset Healthcare Solutions	4-5
Sleepnet	6-7
Circadiance	8-9
InnoMed	10-11
Airway Management	11
Machines	12
Tubing	13
Filters	14-22
Respironics	14-15
ResMed	16-17
Fisher & Paykel	18
3B	19
AEIOMed	19
Breas/GE	19
CareFusion/Viasys	20
Covidien Nellcor Puritan Bennett	20
DeVilbiss	21
Evo Medical	21
Healthdyne	22
Invacare	22
ProBasics	22
Humidifier Chambers	23
Chinstraps	24-25
Headgear	25
Cash Items	26-33
Cleaners	26-27
Somnifix	28
Mask Liners	28
Batteries	29
Self Care and Organization	30-31
Connectors, Adapters, and Inline Filter	31
Tubing Wraps	32

Oxygen

	Page
Firesafe	34
Masks	35
Pulse Oximeters	35
Cannula	36-37
Tubing	37
Water Traps	37
Regulators and Conserver	38
Cylinder Carriers	40-41
Connectors and Adapters	42
Accessories	43-44
Cleaners	44
Bacteria and HEPA Filters	45
Concentrator Cabinet Filters	46-51
Caire/AirSep/SeQual	46
CHAD	47
Covidien Nellcor Puritan Bennett	47
DeVilbiss/Drive	48
Inogen	49
Invacare	49
Nidek	50
3B	50
Respironics/Healthdyne	51

Other

	Page
Aerosol	53
Compressor Nebulizers	54
Mesh Nebulizers	55
Nebulizer Kits	56
Nebulizer Filters	57
Suction	58-59
Tracheostomy	60
Ventilator Filters, Masks, and Connectors	61
Ventilator Circuits	62-63
Breast Pumps and Accessories	64
MADA Cleaners	65
Therapy and Comfort	66
Mobility	67
PPE	68-69

SUNSET HEALTHCARE SOLUTIONS

Sunset Deluxe Full Face CPAP Masks

Mask with Flex Tube, Headgear, and Replaceable Cushion

Size	Item#
Small	CM005S
Medium	CM005M
Large	CM005L

Unobtrusive design offers a clear line of sight



HG003 Headgear - Fits Most
HG003XL Headgear - XL

CMSIZE01
Deluxe Sizing Guide

HCPCS#
MASK - A7030
HEADGEAR - A7035
CUSHION - A7031

Mask without Headgear

Size	Item#
Small	CM005SNH
Medium	CM005MNH
Large	CM005LNH

Replacement Cushions

Size	Item#
Small	CUCM005S
Medium	CUCM005M
Large	CUCM005L

- 360° dual-swivel elbow port allows for free movement while connected to the tubing
- Quick-release clips make it easy to remove the mask without resetting the headgear
- Ultra-lightweight silicone replaceable cushion increases comfort while maintaining optimal seal

Mask with Adjustable Forehead T, Headgear, and Replaceable Cushion

Size	Item#
Small	CM105S
Medium	CM105M
Large	CM105L

NEW



Sunset Deluxe Nasal CPAP Masks

Mask with Headgear and Replaceable Cushion

Size	Item#
Small	CM006S
Medium	CM006M
Large	CM006L

Same features as the full face with 360° dual-swivel elbow port, quick release clips, and ultra-lightweight replaceable cushions.



HG003 Headgear - Fits Most
HG003XL Headgear - XL

CMSIZE01
Deluxe Sizing Guide

HCPCS#
MASK - A7034
HEADGEAR - A7035
CUSHION - A7032

Mask without Headgear

Size	Item#
Small	CM006SNH
Medium	CM006MNH
Large	CM006LNH

Replacement Cushions

Size	Item#
Small	CUCM006S
Medium	CUCM006M
Large	CUCM006L

Mask with Headgear, Adjustable Forehead T, and Replaceable Cushion

Size	Item#
Small	CM106S
Medium	CM106M
Large	CM106L

NEW



SUNSET HEALTHCARE SOLUTIONS

Sunset Deluxe Nasal Pillow CPAP Mask

Item#

CM036

Mask with Headgear and Small, Medium, and Large Pillows

HG036

Headgear Only

HCPCS#

MASK - A7034

HEADGEAR - A7035

PILLOWS - A7033



Replacement Pillows

Size Item#

Small **CM036SP**

Medium **CM036MP**

Large **CM036LP**



Mask without Headgear

CM036NH

- Easy to fit, assemble, and maintain
- Three different pillow sizes to fit more people more easily
- 360° rotational elbow with flexible silicone tube
- Quiet vent design

Sunset Clearsight Deluxe Nasal Mask

Mask with Headgear and Replaceable Cushion

Size Item#

Small **CM110S**

Medium **CM110M**

Large **CM110L**



HG003 Headgear - Fits Most

HG003XL Headgear - XL

Replacement Cushions

Size Item#

Small **CUCM110S**

Medium **CUCM110M**

Large **CUCM110L**

HCPCS#

MASK - A7034

HEADGEAR - A7035



- Clearsight design provides unobstructed view

Mask Series	Mask Type	Replaceable Cushion	Forehead Support	Flex Tube Included	Headgear Included
CM005	Full Face	✓		✓	✓
CM105	Full Face	✓	✓ (Adjustable)		✓
CM006	Nasal	✓	✓	✓	✓
CM106	Nasal	✓	✓ (Adjustable)		✓
CM007	Full Face				✓
CM008	Nasal				✓
CM110	Nasal	✓			✓
CM036	Nasal Pillow	✓		✓	✓

Sunset Classic Full Face CPAP Mask



Mask with Headgear

Size Item#

Small **CM007S**

Medium **CM007M**

Large **CM007L**

Extra Large **CM007XL**

HG003 Headgear - Fits Most

HG003XL Headgear - XL

CMSIZE02

Classic Sizing Guide

HCPCS#

MASK - A7030

HEADGEAR - A7035

1/2 THE WEIGHT OF LEADING MASKS

- Conventional forehead pad removed
- to create a clear line of sight
- Minimalist design and ultra-lightweight silicone
- Quick-release clips make it easy to remove
- 360° dual-swivel elbow port allows for free movement
- One-piece mask and cushion design is durable and easy

Sunset Classic Nasal CPAP Mask



Mask with Headgear

Size Item#

Medium **CM008M**

Large **CM008L**

HG003 Headgear - Fits Most

HG003XL Headgear - XL

CMSIZE02

Classic Sizing Guide

HCPCS#

MASK - A7034

HEADGEAR - A7035

- Great value for cash patients or those with lower insurance reimbursement
- Headgear clips allow for quick removal of mask — no further adjustments required after initial fitting
- One-piece mask and cushion design is durable and easy

Visit www.sunsethcs.com



SLEEPNET

Innova

Nasal Mask with Headgear

Size	Item#
Small/Medium	CM034SM
Medium/Large	CM034ML

HCPCS#
MASK - A7034
HEADGEAR - A7035

Full Face Mask with Headgear

Size	Item#
Small	CM035S
Medium	CM035M
Large	CM035L

HCPCS#
MASK - A7030
HEADGEAR - A7035



Innova® CPAP masks feature patented AIR^ogel with Advanced Cushion Technology and Active Headgear Connector™. Together, they provide an optimal fit, maximum comfort, and freedom.

- The Touchless Spacebar's unique design eliminates any contact with the patient's forehead
- The quick-release headgear is lightweight, breathable, and slides off easily with one hand
- Made in the USA

MiniMe Pediatric Nasal Mask

Mask with Headgear

Headgear Size	Item#	OEM#
Small	CM004S	60213
Medium	CM004M	60214
Large	CM004L	60215



Replacement Headgear

Size	Item#	OEM#
Small	HG010S	55241
Medium	HG010M	55242
Large	HG010L	55243

HCPCS#
MASK - A7034
HEADGEAR - A7035

- Non-vented version available

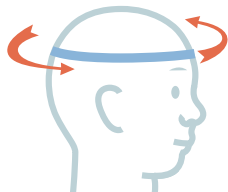

MASK SIZE	HEAD CIRCUMFERENCE
SMALL	14-16in
MEDIUM	17-18in
LARGE	19-21in

Measure around head above eyebrows for head circumference

MiniMe 2 Pediatric Nasal Mask

Mask with Headgear

Size	Item#	OEM#
Extra Small	CM027XS	60216
Small	CM027S	60217
Medium	CM027M	60218
Large	CM027L	60221



Replacement Headgear

Size	Item#
Extra Small/Small	HG027S
Medium/Large	HG027L

HCPCS#
MASK - A7034
HEADGEAR - A7035

- Non-vented version available



Ascend

Nasal Mask with Headgear and All Cushions

Item# **CM037N**

Replacement Cushions

Size	Item#
Small	CM037NCS
Medium	CM037NCM
Large	CM037NCL

Nasal Mask with Headgear and 1 Cushion

Size	Item#
Small	CM037NS
Medium	CM037NM
Large	CM037NL

HCPCS#
 MASK - A7034
 HEADGEAR - A7035
 CUSHION - A7032

Full Face Mask with Headgear and All Cushions

Item# **CM037F**

Replacement Cushions

Size	Item#
Small	CM037CS
Medium	CM037CM
Large	CM037CL

Full Face Mask with Headgear and 1 Cushion

Size	Item#
Small	CM037S
Medium	CM037M
Large	CM037L

HCPCS#
 MASK - A7030
 HEADGEAR - A7035
 CUSHION - A7031

- One frame with three sizes of replaceable cushions: S, M, L
- Unique flexible spacebar design provides superior stability, holding a seal without contacting the skin
- Sleepnet's patented AIR^ogel minimizes pressure points and skin irritation while offering maximum comfort with minimum weight
- Lightweight, breathable quick-release headgear slides off easily with one hand
- 360-degree rotating elbow for optimal tube positioning and easier mobility
- Active Headgear Connector moves as the patient moves for a reliable seal
- Made in the USA

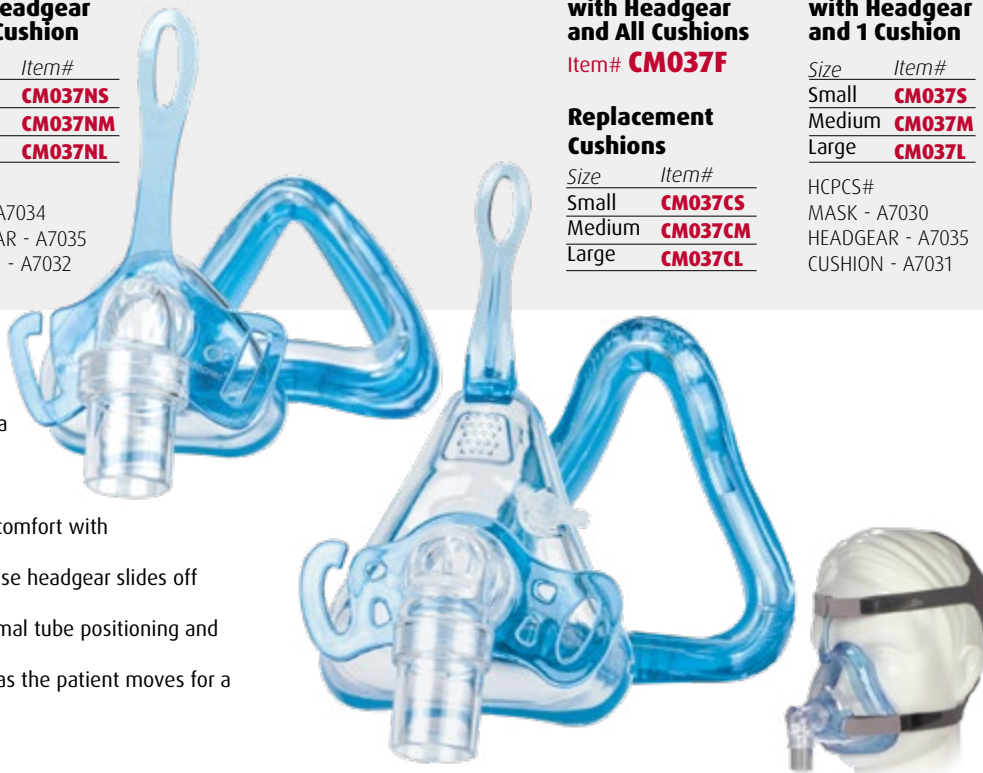

iQ Nasal Mask

Item# **CM001**

iQ Nasal Mask with Headgear
 OEM# TMS-889

HG005
 3-Point Headgear Only
 OEM# TMS-89-55046

HCPCS#
 MASK - A7034
 HEADGEAR - A7035

HG009
 Holey Cap Style Headgear Only



Mojo Full Face Mask

Mask with Headgear

Size	Item#	OEM#
Small	CM003SH	TMS-835
Medium	CM003MH	TMS-836
Large	CM003LH	TMS-837

Replacement Headgear

HG003
 OEM# TMS-89

HCPCS#
 MASK - A7030
 HEADGEAR - A7035



Mojo 2 Full Face Mask

Mask with Headgear

Size	Item#	OEM#
Small	CM50817	50817
Medium	CM50818	50818
Large	CM50819	50819
Extra Large	CM50820	50820

NEW

- Maximum comfort, minimum weight. Patented AIR^ogel minimizes pressure points and skin irritation.
- Forehead adjustment screw removes pressure from the bridge of the nose for personalized fit.
- The shapeable shell of each mask can be easily molded to fit individual needs. Bend it. Mold it. Shape it.
- Lightweight, breathable headgear disconnects from mask easily with one hand thanks to the quick-release magnetic headgear clips.
- Oxygen port allows easy delivery of supplemental oxygen.
- 360° rotating elbow for optimal tube positioning and easier mobility.



CIRCADIANCE

SleepWeaver® Advance Nasal Mask



Blue

- One size fits most (Small Tan available for smaller faces)
- Includes Advance headgear that can be adjusted to fit a broader range of patients



Leopard



Camo



Pink



Tan

Mask with Adjustable Headgear

Mask Color	Item#	OEM#
Blue	CM017B	100274
Camo	CM017C	100281
Leopard	CM017L	100285
Pink	CM017P	100277
Tan	CM017T	100332

CM017T-S
Small Tan
OEM# 101224

HCPCS#
MASK - A7034
HEADGEAR - A7035

HG017
Headgear Only
OEM# 100435

CM017TNH
Tan — No Headgear
OEM# 100336

- Easy to store and pack for travel

SleepWeaver® Élan Nasal Mask

Mask Kit

Mask Color	Item#	OEM#
Tan	CM022T-KIT	100563
Blue	CM022B-KIT	100782

Kits Include:

- Mask
- Small Cushion
- Regular Cushion
- Large Cushion
- Headgear
- Feather Weight Tube®
- Overhead Tube Tether Strap
- Quick Start Illustration Guide
- Instructional DVD

HCPCS#
MASK - A7034
HEADGEAR - A7035
TUBE - A7037

TUB0018F
Replacement
Feather Weight Tube®
OEM# 100477

HG022
Headgear Only
OEM# 100630

Mask with Headgear only

Size and Color	Item#	OEM#
Small Blue	CM022B-S	100728
Regular Blue	CM022B-R	100519
Large Blue	CM022B-L	100482
Small Tan	CM022T-S	100727
Regular Tan	CM022T-R	100518
Large Tan	CM022T-L	100481

All SleepWeaver Masks

- Made of soft cloth
- Allow sleeping on side, stomach, and even wearing glasses
- Easy to store and pack for travel
- Hand or machine washable gentle cycle, mild detergent, hang to dry

Replacement Cushions

Size and Color	Item#	OEM#
Small Blue	CUCM022B-S	100743
Regular Blue	CUCM022B-R	100654
Large Blue	CUCM022B-L	100664
Small Tan	CUCM022T-S	100742
Regular Tan	CUCM022T-R	100653
Large Tan	CUCM022T-L	100663
Small Leopard	CUCM022L-S	100746
Reg. Leopard	CUCM022L-R	100657
Large Leopard	CUCM022L-L	100667



- Detachable 90° elbow with 360° rotation allows for over-the-head hose placement

SleepWeaver® Anew™ Full Face Mask

Blue Mask with Headgear

Size	Item#	OEM#
Small	CM026B-S	100955
Regular	CM026B-R	100960
Large	CM026B-L	100965

Headgear

Size	Item#	OEM#
Small	HGCM026-S	101145
Reg/Lg	HGCM026-R	101084

TUB0018F

Featherweight Tube
OEM# 100477

HCPCS#
MASK - A7027
HEADGEAR - A7035
TUBE - A7037



- Soft material wicks away moisture and leaves no pressure marks on the face
- Loose fit provides ultimate comfort and eliminates strap marks
- Open line of sight accommodates eyeglasses and is great for people who like to fall asleep while reading or watching TV
- 90° elbow swivel connector rotates 360° allowing users to sleep in more natural positions; easy to remove and clean

Pediatric SleepWeaver® CPAP Mask

Item#
CM101325

- Same proven cloth technology enhanced to accommodate children 2 through 7 years of age



The launch of the SleepWeaver Advance Pediatric Soft Cloth CPAP Mask marks the development of a revolutionary interface for CPAP use in pediatric patients. This new configuration extends the range of SleepWeaver products to include pediatric users with delicate facial features.

Visit www.sunsethcs.com

Aloha® Nasal Pillows System

Item#

CM014

All Sizes Kit

OEM# ALO100

Replacement Headgear

HG014

Aloha Headgear

OEM# ALO130

Replacement Pillows

Size	Item#	OEM#
Small	CM014SP	ALO121
Medium	CM014MP	ALO123
Large	CM014LP	ALO125



Frame

Size	Item#	OEM#
Small	CM014FS	ALO131
Medium	CM014FM	ALO133
Large	CM014FL	ALO135

HCPCS#

MASK - A7034

HEADGEAR - A7035

PILLOWS - A7033

- One of the highest consumer-rated CPAP masks on the market
- Limited headgear reduces points of contact on the face and prevents interference with the eyes
- Removable micro-fleece headgear wraps are included for comfort
- Pillow angle can be adjusted for a more customized and natural fit

NasalAire II® Mask

Item#

CM016

All Sizes Kit

OEM# K2A

Mask with Frame, Pillows, and Headgear

Size	Item#	OEM#
Extra Small	CM016XS	XS301
Small	CM016S	SM302
Medium	CM016M	MD303
Medium Plus	CM016MP	MP304
Large	CM016L	LG305
Extra Large	CM016XL	XL306

Petite Mask with Frame, Pillows, and Headgear

Size	Item#	OEM#
A (Largest)	CM016PA	PA401
B	CM016PB	PB402
C	CM016PC	PC403
D	CM016PD	PD404
E (Smallest)	CM016PE	PE405

HCPCS#

MASK - A7034

HEADGEAR - A7035

PILLOWS - A7033

Replacement Headgear

Regular **HG016** OEM# X2105

Petite **HG016P** OEM# P430



Replacement Nasal Piece/Cannula

Size	Item#	OEM#
Extra Small	CM016XSCAN	XS01
Small	CM016SCAN	SM02
Medium	CM016MCAN	MD03
Medium Plus	CM016MPCAN	MP04
Extra Large	CM016XLCAN	XL06

Replacement Frame

Size	Item#	OEM#
Extra Small	CM016FXS	NAT321
Small	CM016FS	NAT322
Medium	CM016FM	NAT323
Medium Plus	CM016FMP	NAT324
Large	CM016FL	NAT325
Extra Large	CM016FXL	NAT326

Replacement Petite Nasal Piece/Cannula

Size	Item#	OEM#
A (Largest)	CM016PACAN	PA411
B	CM016PBCAN	PB412
C	CM016PCCAN	PC413
D	CM016PDCAN	PD414
E (Smallest)	CM016PECAN	PE415

Hybrid® Mask

Item# **CM015**

All Sizes Kit
OEM# HYB500

Replacement Headgear

HG015
Hybrid Headgear
OEM# HYB530



Replacement Pillows

Size	Item#	OEM#
Small	CM015SP	HYB521
Medium	CM015MP	HYB523
Large	CM015LP	HYB525

Replacement Cushions

Size	Item#	OEM#
Small	CUCM015S	HYB511
Medium	CUCM015M	HYB513
Large	CUCM015L	HYB515



HCPCS#
MASK - A7027
HEADGEAR - A7035
PILLOWS - A7033
CUSHION - A7031

Aspen® Mask

Mask with Headgear and Cushion

Size	Item#	OEM#
Small	CM029S	ASP201
Medium	CM029M	ASP203
Large	CM029L	ASP205

Replacement Headgear

HG029 Aspen Headgear
OEM# ASP230

HCPCS#
MASK - A7030
HEADGEAR - A7035
CUSHION - A7031



Replacement Cushions

Size	Item#	OEM#
Small	CUCM029S	ASP211
Medium	CUCM029M	ASP213
Large	CUCM029L	ASP215

The Aspen is compact, quiet, lightweight, and affordable.

- Built-in chin flap gently supports the chin
- Resilient yet stable forehead pad is highlighted by a SoftTouch Wrap
- Headgear features a crown strap for extra comfort and support
- Headgear has five adjustment points
- Extremely quiet exhalation port design
- All 3 cushion sizes fit the single mask shell

AIRWAY MANAGEMENT

Tap Pap

No headgear needed!

Item#
CM024NH

Mask Kit with Small, Medium, and Large Pillows
OEM# PAP-NP1-000

Replacement Pillows

Size	Item#	OEM#
Small	CUCM024S	PAP-NP1-101
Medium	CUCM024M	PAP-NP1-102
Large	CUCM024L	PAP-NP1-103

CM024NH

Mask Kit without Headgear
OEM# PAP-NP1-001

HG024

Tap Pap Headgear
OEM# PAP-NP1-300

CM024MP

Replacement Mouthpiece
OEM# PAP-NP1-201

HCPCS#

MASK - A7034
PILLOWS - A7033
HEADGEAR - A7035



- Mouthpiece molds to the upper teeth to provide a custom and secure fit even if the bottom teeth are not in contact with the mouthpiece
- Unique nut and bolt joint allows the nasal pillows to be set to the desired angle
- Provides a stable fit regardless of the sleep position
- Patients report not being able to feel the mask on their face
- 3 sizes of nasal pillows included (Small, Medium, and Large)
- 90-day compliance guarantee for new users of the mask, 30-day guarantee for experienced users

We also carry Respronics and Fisher & Paykel masks. Please contact your sales rep for more info.

SOMNETICS

Transcend miniCPAP

Item# **CAPSOMAUTOT3**
Transcend 3 miniCPAP Auto

- Smallest size for ultimate portability

Add ons

Type	Item#
P8 Multi Night Battery	CAPSOM503026
Portable Foldout Solar Charger	CAPSOM503056
DC Power Adapter	CAPSOM503029



Included

- Transcend 3 miniCPAP Auto
- Padded travel case with compartments
- Standard 6-foot tube
- Multi-plug universal AC power supply with international plug kit
- Mini USB cord
- Transcend 3 Quick Guide

Features

- Upgraded design: modern look, flat silicone base for improved stability, swivel nozzle for a better CPAP experience
- The best value of any travel CPAP with quality design and an industry-leading warranty
- Small, lightweight and portable for an active/mobile lifestyle
- Extremely easy to pack and carry, easily fits into a briefcase or purse
- Durable, high quality miniCPAP built for travel
- The most power accessories so patients can sleep anywhere
- Compatible with any CPAP mask and any tubing with a standard 22mm connector
- Follows FAA guidelines for inflight use
- 3-year warranty

Item# **CAPSOMAUTO365**
Transcend 365 miniCPAP Auto

- The world's lightest integrated CPAP and heated humidifier for every day use and travel

Add ons

Type	Item#
P10 Battery	CAPSOM503098



Included

- Transcend 365 miniCPAP Auto
- Padded travel case with compartments
- Universal AC power supply
- Mini USB cord
- Transcend 365 Quick Guide

Features

- Footprint approximately half the size of any other CPAP and heated humidifier on the market
- New, patented Smart Humidification™ with CFV™ technology humidifies only on inhale, requiring less water and less power consumption
- Smart Power™ management for battery-powered CPAP and heated humidification (with optional P10 Battery)
- Compatible any mask or tube with a standard 22mm connector
- Follows FAA guidelines
- 2-year warranty

Ask for
FREE
marketing
materials



3B MEDICAL

Luna II

Machine with Heated Humidifier

Type	Item#
Auto	CAPLG2A00
CPAP	CAPLG2000

HUMCAPL24510
Replacement Humidifier
Water Chamber

CAPWL-300
4G LTE Cellular Module
Includes 2-Year Data Plan

CAPLWF10
WiFi Module



- Reslex® Expiratory Pressure Relief
- Wireless capability for automated data capture
- Integrates with iCodeConnect™, 3B's interactive, completely configurable patient management system
- The most no-cost data capture options in the industry
 - WiFi capable
 - iCode®
 - Smartphone app scan and upload
 - SD Card
- Next generation wireless network NB IoT & LTE-M
- My PatientWatch with automated compliance notifications
- Great value for reimbursement
- Attainable for out-of-pocket patients
- Crystal clear LCD display allows for easy viewing of settings
- Single dial menu access for quick, easy setting adjustments
- Innovative dual chamber humidifier provides greater efficiency
- 2-year warranty, tough and durable
- Quiet operation
- Real time audible alert for tubing/mask leak
- Reslex® exhalation relief with three comfort settings
- Previous night's compliance-therapy snapshot to assist patient with compliance
- Automatic leakage and altitude compensation
- Inspiration trigger for automatic start-up

HCPCS#
DEVICE - E0601
HEATED HUMIDIFIER - E0562

SUNSET HCS TUBING

Durable CPAP Tubing — Gray



Item#
TUB06
6ft
19mm with 22mm cuffs
HCPCS# A7037

- Sunset's most popular item
- Compatible with nearly all CPAP, BiPAP and BiLevel systems for every manufacturer on the market
- Smooth interior and a corrugated exterior for excellent flexibility and unrestricted interior flow characteristics
- Injection molded cuffs to reduce tearing
- Low memory to avoid kinks
- BPA-free and latex-free

All Lengths

TUB0018	18in
TUB002	2ft
TUB004	4ft
TUB06	6ft
TUB006.5	6ft 6in — Compatible with ResMed tube wraps
TUB007	7ft
TUB008	8ft
TUB009	9ft
TUB010	10ft

Compatible with Sunset's new quick release connector!

Item#
CAP1016



Slim CPAP Tube

Item#
TUB006SS
6ft x 15mm with 22mm cuffs
HCPCS# A7037



Highly durable
Strain relief cuff decreases separation and tearing

Virtually no memory
Designed to be the most flexible tube available

Minimal weight
One of the lightest tubes on the market at 2.6 ounces

Great value
Affordable and sustainable

Heated Tubing

Item#
TUB06HPR **NEW**
Heated Tube for
Philips Respironics
Dreamstation
and System One
OEM# HT15
HCPCS# A4604

- 510(k)
- UL Recognized
- Strain relief cuffs
- Auto safety shut-off

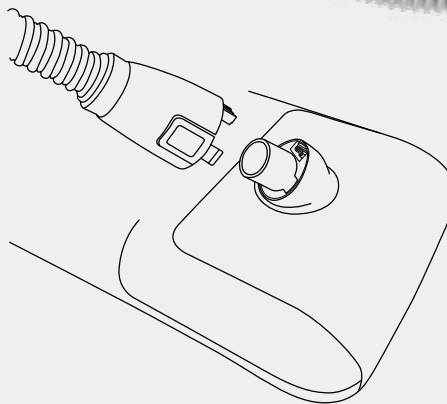

TUBHC900ICON208
Heated Tube for Fisher & Paykel ICON
OEM# 900ICON208

Pressure Port Tubing

Item# **TUB006PP**
6ft with Pressure Sensor Lines
22mm Cuffs • HCPCS# A7037

- Built-in sensor line for use with the Puritan Bennett: GoodKnight 420S, 420E and 425 and KnightStar 330



Visit www.sunsethcs.com



DreamStation



Item# **CF1010**
 Disposable Filter
6/pack
 OEM# 1122519
 HCPCS# A7038
CF1010-1 1/pack
CF1010-2 2/pack

Item# **CF1010F**
 Reusable Filter
2/pack
 OEM# 112446 (1-pack)
 HCPCS# A7039
CF1010F-1 1/pack
CF1010F-6 6/pack

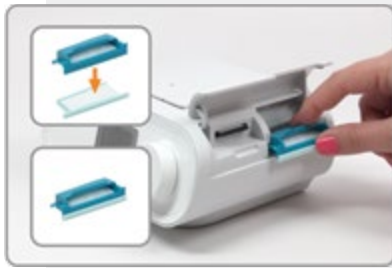

DreamStation Go Filters



Item# **CF101130D**
 30-Day Disposable Filter
6/pack
 OEM# 1133744
 HCPCS# A7038

Item# **CF101190D**
 90-Day Reusable Filter
2/pack
 OEM# 1133743
 HCPCS# A7039

PR System One



Item# **CF1009NT**
 Ultrafine Filter - No Tab
6/pack • 1³/₄" x 7⁸/₈"
 OEM# 1029331
 HCPCS# A7038
CF1009NT-1 1/pack
CF1009NT-2 2/pack



Item# **CF1009**
 Ultrafine Filter - Tabbed
6/pack • 1³/₄" x 7⁸/₈"
 HCPCS# A7038
CF1009-1 1/pack
CF1009-2 2/pack



Item# **CF1009F**
 Foam Filter
2/pack • 1⁵/₈" x 7⁸/₈"
 OEM# 1029330
 HCPCS# A7039
CF1009F-1 1/pack

M-Series



Item# **CF1007**
 Ultrafine Filter - Tabbed
6/pack • 1³/₄" x 7⁸/₈"
 HCPCS# A7038
CF1007-1 1/pack
CF1007-2 2/pack

Item# **CF1007F**
 Foam Filter
2/pack • 1⁵/₈" x 7⁸/₈"
 HCPCS# A7039
CF1007F-1 1/pack

Item# **TUB06CF1009NTF**
 PR System One No Tab Filter
 and CPAP Tube Kit
 1 - CF1009NT
 1 - CF1009F
 1 - 6ft CPAP Tube



*Private labeling and kitting
 available at no extra charge*

RESPIRONICS

BiPAP Pro, Plus, Duet LX, Synchrony



Item# **CF1005**
Ultrafine Filter
6/pack • 4^{3/4}" x 3^{1/4}"
OEM# 622219
HCPCS# A7038

Item# **CF1005F**
Foam Filter
2/pack • 4^{3/4}" x 2^{3/8}"
OEM# 622220
HCPCS# A7039

REMstar Pro, REMstar Plus



Item# **CF1006**
Ultrafine Filter
2/pack • 3^{1/2}" x 1^{1/2}"
OEM# 1005945
HCPCS# A7038

Item# **CF1006F**
Foam Filter
2/pack • 3^{5/8}" x 1^{5/8}"
OEM# 1005964
HCPCS# A7039

REMstar



Item# **CF1003**
Ultrafine Filter
6/pack • 5^{1/2}" x 4^{3/4}"
OEM# 362522
HCPCS# A7038

Item# **CF1003F**
Foam Filter
1/pack • 5^{3/4}" x 5^{1/4}"
OEM# 362521
HCPCS# A7039

Aria, Virtuoso, Duet, Quartet



Item# **CF1004**
Ultrafine Filter
6/pack • 3^{1/2}" x 2^{3/16}"
OEM# 532311
HCPCS# A7038

Item# **CF1004F**
Foam Filter
2/pack • 3^{1/4}" x 2^{1/8}"
OEM# 532247
HCPCS# A7039

SleepEasy/BiPAP



Item# **CF1001**
Ultrafine Filter
6/pack • 7^{3/4}" x 4^{7/8}"
OEM# 302064
HCPCS# A7038

Solo, Aria LX, Virtuoso LX, REMstar LX

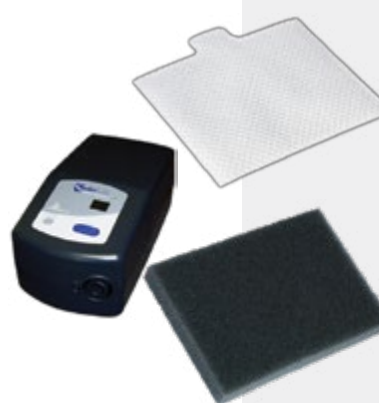

Item# **CF1002**
Ultrafine Filter
6/pack • 3^{3/8}" x 2^{3/4}"
OEM# 622017
HCPCS# A7038

Item# **CF1002F**
Foam Filter
2/pack • 3^{5/16}" x 2^{5/16}"
OEM# 622018
HCPCS# A7039

Filter Replacement for Respironics Machines

Step 1 Insert the white ultrafine filter with the webbed plastic or shiny side facing in toward the machine. This filter protects the patient from bacteria and allergens in the air.

Step 2 Place black foam filter in second to protect the machine from large particles and pollen.



*All filters can be ordered in any pack quantity.
Contact your sales rep for details.*

AirMini



Item# **CF2108**
 Disposable Filter
2/pack • 1¹/₄" x 1³/₁₆"
 OEM# 38815
 HCPCS# A7038

S9 and AirSense 10 Series



Item# **CF2107**
 Disposable Filter
3/pack • 2¹/₈" x 1³/₈"
 HCPCS# A7038

CF2107-1 1/pack OEM# 36850
CF2107-2 2/pack OEM# 36851
CF2107-50 50/pack OEM# 36853

Item# **TUB06S9COMBO**
 S9 Filter and CPAP Tube Kit
 6 - CF2107
 1 - 6ft CPAP Tube



KIT

Item# **CF2107HA**
 Hypoallergenic Filter
3/pack • 2¹/₈" x 1³/₈"
 HCPCS# A7038

CF2107HA-1 1/pack OEM# 36855
CF2107HA-2 2/pack OEM# 36856
CF2107HA-50 50/pack
 OEM# 36858

Adapt SV



Item# **CF2106**
 Disposable Filter
3/pack • 1¹/₄" x 1¹/₂"
 OEM# 26926
 HCPCS# A7038

CF2106-50 50/pack

Item# **CF2106HA**
 Hypoallergenic Filter
3/pack • 1¹/₄" x 1¹/₂"
 OEM# 26927
 HCPCS# A7038

CF2106HA-50 50/pack

Auto Set T



Item# **CF2104**
 Disposable Filter
3/pack • 4¹/₄" x 3¹/₄"
 OEM# 17937
 HCPCS# A7038

CF2104-50 50/pack OEM# 17938

Filter Replacement for ResMed Machines

- Step 1** Open air filter hatch on back of machine.
- Step 2** Remove old filter and discard. Filters are not washable/reusable.
- Step 3** Insert filter with blue side facing out. If using S9 or AirSense 10 filters, insert any side.
- Step 4** Close air filter hatch.

S8 Series

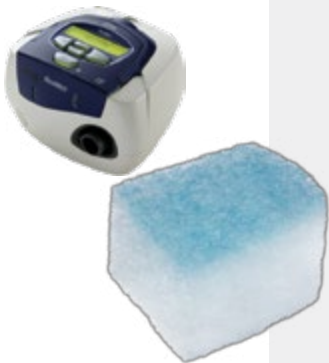

Item#
CF2105
Disposable Filter
3/pack • 1³/₈" x 1³/₈"
OEM# 33916
HCPCS# A7038

CF2105-1 1/pack OEM# 33915
CF2105-2 2/pack OEM# 33973
CF2105-50 50/pack OEM# 33918



KIT

Item#
TUB06S8COMBO
S8 Filter and CPAP Tube Kit
6 - CF2105
1 - 6ft CPAP Tube



Item#
CF2105HA
Hypoallergenic Filter
3/pack • 1³/₈" x 1³/₈"
OEM# 33920
HCPCS# A7038

CF2105HA-1 1/pack OEM# 33919
CF2105HA-2 2/pack OEM# 33975
CF2105HA-50 50/pack OEM# 33922

S7 Series



Item#
CF2103
Disposable Filter
3/pack • 1¹/₄" x 1¹/₂"
OEM# 30907
HCPCS# A7038

CF2103-1 1/pack OEM# 30919
CF2103-2 2/pack
CF2103-50 50/pack OEM# 30908

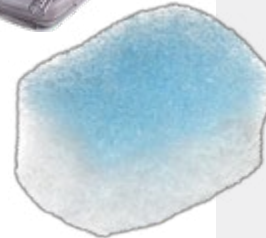

Item#
CF2103HA
Hypoallergenic Filter
3/pack • 1¹/₄" x 1¹/₂"
HCPCS# A7038

CF2103HA-1 1/pack OEM# 30933
CF2103HA-50 50/pack

*All filters can be ordered
in any pack quantity.
Contact your sales rep
for details.*

S6 Series



Item#
CF2102
Disposable Filter
3/pack • 5³/₄" x 5⁵/₈"
OEM# 21935
HCPCS# A7038

CF2102-50 50/pack
OEM# 21936

Sullivan VPAP



Item#
CF2101
Foam and Poly Filter Set
3 sets/pack • 6¹/₂" x 3³/₄"
OEM# 14907
HCPCS# A7038, A7039

CF2101-50 50 sets/pack
OEM# 14908

FISHER & PAYKEL

SleepStyle Series



Item#
CF4004
Disposable Filter
4/pack
HCPCS# A7038



NEW

ICON Series



Item#
CF4003
Disposable Filter
4/pack
2 1/16" x 5/8"
HCPCS# A7038



CF4003-1 1/pack
OEM# 900ICON503

CF4003-6 6/pack
OEM# 900ICON212

HC230 Series, HC600 Series



Item#
CF4002
Disposable Filter
4/pack • 2 3/4" x 7/8"
OEM# 900HC240
HCPCS# A7038
CF4002-2 2/pack



HC200, HC220, HC221



Item#
CF4001
Disposable Filter
4/pack • 5" x 3/4"
OEM# 900HC222
HCPCS# A7038
CF4001-2 2/pack



Enhance your branding!

FREE PRIVATE LABELING



Sunset's free service allows you to put your logo and contact information on our products.

Increase brand awareness and allow patients to easily contact you.

Work with our marketing team to customize the layout with your logo, phone number, website address, and reorder information.

Available on all CPAP tubes and filters. Minimum orders apply. Contact your sales rep for details.

FREE CUSTOM PACKAGING

- Create your own resupply kits with everything you need to fill your orders
- Completely customizable to fit your needs
- Sunset can pack anything from a single ultrafine filter to a 3 or 6 month supply of tubes and filters in one easy-to-handle kit

Custom packaging available on all CPAP tubes, filters, connectors and chin straps. Minimum orders apply.



As featured in *HME News*

3B

Luna and Luna II



Item# **CF8005**
Disposable Filter
12/pack • 2" x 1³/₁₆"
HCPCS# A7038

RESmart



Item# **CF8004**
Disposable Filter
3/pack • 3⁵/₁₆" x 1⁵/₈"
HCPCS# A7038

AEIOMED

Everest Aura, Everest III and Integrated

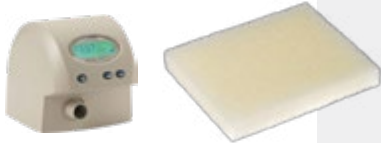

Item# **CF8001**
Foam Filter
2/pack • 2" x 1⁹/₁₆"
OEM# 100446
HCPCS# A7039

BREAS/GE

iSleep 20 Series



Item# **CF7003**
Ultrafine Filter
2/pack • 2¹/₄" x 7⁷/₈"
OEM# 004153
HCPCS# A7038

Item# **CF7003F**
Foam Filter
Each • 2³/₄" x 1"
OEM# 004154
HCPCS# A7039

PV10



Item# **CF7002**
Ultrafine Filter
2/pack • 2³/₄" x 7⁷/₈"
OEM# 2B01975
HCPCS# A7038

Item# **CF7002F**
Foam Filter
Each • 2⁵/₈" x 7⁷/₈"
OEM# 2B01972
HCPCS# A7039

PV1



Item# **CF7001**
Ultrafine Filter
2/pack • 2¹/₂" x 1¹/₄"
HCPCS# A7038

Item# **CF7001F**
Foam Filter
3/pack • 2¹/₂" x 1¹/₄"
HCPCS# A7039

CAREFUSION/VIASYS

PureSom



Item# **CF9003**
Ultrafine Filter
3/pack • 1³/₁₆" x 1⁷/₁₆"
OEM# 7511
HCPCS# A7038

Item# **CF9003F**
Foam Filter
3/pack • 1³/₁₆" x 1⁷/₁₆"
OEM# 7510
HCPCS# A7039

Orion and Pegasus



Item# **CF8002**
Ultrafine Filter
6/pack • 2⁷/₈" x 1³/₄"
OEM# 774688
HCPCS# A7038

Item# **CF8002F**
Foam Filter
Each • 2⁷/₈" x 1³/₄"
OEM# 774689
HCPCS# A7039

COVIDIEN NELLCOR PURITAN BENNETT

GoodKnight 314/318



Item# **CF6005**
Ultrafine Filter
2/pack • 6¹/₈" x 9¹/₁₆"
OEM# S-126924-00
HCPCS# A7038

Item# **CF6005F**
Foam Filter
2/pack • 6¹/₄" x 1"
OEM# S-290609-00
HCPCS# A7039

GoodKnight 420/425



Item# **CF6003**
Ultrafine Filter
2/pack • 1³/₁₆" x 3¹/₁₆"
OEM# M-413950-04
HCPCS# A7038

Item# **CF6003F**
Foam Filter
Each • 1³/₁₆" x 3¹/₁₆"
OEM# M-413950-02
HCPCS# A7039

GoodKnight 418 A/G/P/S



Item# **CF6002**
Ultrafine Filter
4/pack • 5³/₁₆" x 3³/₄"
OEM# Y-413560-01
HCPCS# A7038

Item# **CF6002F**
Foam Filter
6/pack • 5¹/₄" x 3³/₄"
OEM# Y-413560-02
HCPCS# A7039

GoodKnight 418



Item# **CF6001**
Ultrafine Filter
4/pack • 2¹/₄" x 1²/₅"
OEM# S-645030-00
HCPCS# A7038

Item# **CF6001F**
Foam Filter
6/pack • 2⁷/₁₆" x 1¹/₂"
OEM# S-645029-00
HCPCS# A7039

DEVILBISS

IntelliPAP



Item#
CF5004
Ultrafine Filter
4/pack • 1³/₄" x 1¹/₄"
OEM# DV51D-603
HCPCS# A7038

Item#
CF5004F
Foam Filter
4/pack • 1⁵/₈" x 1³/₁₆"
OEM# DV51D-602
HCPCS# A7039

Horizon LT



Item#
CF5003
Ultrafine Filter
4/pack • 4¹/₄" x 1⁵/₁₆"
OEM# 8000D-603
HCPCS# A7038

Item#
CF5003F
Foam Filter
4/pack • 4¹/₄" x 1⁵/₁₆"
OEM# 8000D-602
HCPCS# A7039

EVO MEDICAL

RemRest



Item#
CF8003F
Foam Filter
3/pack • 2³/₁₆" x 1¹/₁₆"
OEM# 21117
HCPCS# A7039

Comfort PAP



Item#
CF9003
Ultrafine Filter
3/pack • 1³/₁₆" x 1⁷/₁₆"
OEM# 7511
HCPCS# A7038

Item#
CF9003F
Foam Filter
3/pack • 1³/₈" x 1¹/₄"
OEM# 7510
HCPCS# A7039

*All filters can be ordered in any pack quantity.
Contact your sales rep for details.*

HEALTHDYNE

Quest



Item# **CF3003**
Ultrafine Filter
with Curves
5/pack • 4¹/₂" x 4³/₈"
OEM# 7302
HCPCS# A7038

Item# **CF3003F**
Foam Filter
with Curves
5/pack • 4¹/₂" x 4¹/₄"
OEM# 7070
HCPCS# A7039

Tranquility MPR



Item# **CF3002**
Ultrafine Filter
Rectangle/Curve
5/pack • 4⁵/₁₆" x 1⁷/₈"
OEM# 7270
HCPCS# A7038

Item# **CF3002F**
Foam Filter
5/pack
5" x 2¹/₄" x 2¹/₈"
OEM# 7301
HCPCS# A7039

Tranquility



Item# **CF3001**
Ultrafine Filter
5/pack • 5¹/₈" x 1⁷/₈"
OEM# 7170
HCPCS# A7038

*All filters can be ordered
in any pack quantity.
Contact your sales rep
for details.*

INVACARE

Polaris LT



Item# **CF9002**
Ultrafine Filter
3/pack • 5" x 2"
OEM# 1082428
HCPCS# A7038

Item# **CF9002F**
Foam Filter
3/pack • 5" x 2"
OEM# 1082995
HCPCS# A7039

Polaris EX



Item# **CF9001**
Ultrafine Filter
3/pack • 2³/₁₆" x 1"
HCPCS# A7038

Item# **CF9001F**
Foam Filter
3/pack • 2¹/₄" x 1¹/₁₆"
OEM# 1124211
HCPCS# A7039

Polaris TR



Item# **CF8001**
Foam Filter
2/pack • 2" x 1⁹/₁₆"
OEM# 100446
HCPCS# A7039

PROBASICS

Zzz-PAP



Item# **CF9003**
Ultrafine Filter
3/pack • 1³/₁₆" x 1⁷/₁₆"
OEM# 7511
HCPCS# A7038

Item# **CF9003F**
Foam Filter
3/pack • 1³/₁₆" x 1⁷/₁₆"
OEM# 7510
HCPCS# A7039

FISHER & PAYKEL

Humidifier Chamber for ICON Series



Item# **HUMHC900ICON200**
 Replacement Chamber for the
 Fisher & Paykel ICON Series
Each OEM# 900ICON200 · HCPCS# A7046

Compatible with: · ICON Premo
 · ICON Novo
 · ICON Auto



Humidifier Chambers for HC200 Series



Item# **HUMHC355**
 Extended Life Humidifier Chamber
 for the Fisher & Paykel HC200 Series
Each OEM# HC 355



Item# **HUMHC385**
 Replacement Chamber for the Fisher
 & Paykel SleepStyle HC200 Series
Each OEM# HC 385S

HCPCS# A7046



Compatible with: · HC200 · HC231 · HC236
 · HC201 · HC232 · HC238
 · HC220 · HC233 · HC242
 · HC221 · HC234 · HC244
 · HC254

Humidifier Chambers for HC100 Series



Item# **HUMHC300**
 Extended Life Humidifier Chamber
 for the Fisher & Paykel HC100 Series
Each OEM# HC 300



Item# **HUMHC325S**
 Replacement Chamber for the
 Fisher & Paykel HC100 Series
Each OEM# HC 325S
 HCPCS# A7046

Compatible with: · HC100
 · HC105
 · HC150



Humidifier Chamber for HC600 Series



Item# **HUMHC365**
 Replacement Chamber for the
 Fisher & Paykel SleepStyle 600 Series
Each OEM# HC 365S · HCPCS# A7046

Compatible with: · HC604
 · HC608



3B

3B Humidifier Chambers



Item# **HUMCAPL24510**
 Replacement Chamber for
 3B Luna II Series
Each OEM# LG24510 · HCPCS# A7046



Item# **HUMCAPL4510**
 Replacement Chamber for 3B
 Luna Series
Each OEM# L4510 · HCPCS# A7046



Item# **HUMCAP3B**
 Replacement Chamber for
 3B RESmart Series
Each OEM# M4510 · HCPCS# A7046

RESPIRONICS

Humidifier Chamber for PR System One



Item# **HUM1136502**
 Humidifier Chamber for PR System
 One 60 Series
Each HCPCS# A7046

DEVILBISS

Humidifier Chamber for IntelliPAP



Item# **HUMDV5C**
 Humidifier Chamber for DeVilbiss
 IntelliPAP Series
Each HCPCS# A7046

SUNSET CHINSTRAPS

All chinstraps are latex-free • Hand wash only • Lay flat to dry

Universal Neoprene Chinstrap



Item# **CS001**
 Universal Chinstrap
 HCPCS# A7036

- One size fits most
- Attaches to itself at the top of the head
- Can be used with any nasal mask or pillows

Basic Chinstrap



Item# **CS002**
 Compare to
 Resprionics Basic
 OEM# 302175
 HCPCS# A7036

- One size fits most
- Attaches to the top strap of headgear
- Cups the chin for comfort
- Works best with any nasal mask

Adjustable Neoprene Chinstrap



Size	Item#
6in	CS003S
7in	CS003R
8in	CS003M
9in	CS003L
10in	CS003XL

Compare to Puresom
 Adjustable Ruby
 OEM# TMS-09 ADJ
 HCPCS# A7036

- Thin adjustable strap attaches at the top of the head. Thicker bottom strap attaches to itself at the back of the head.
- Great for hard-to-fit patients

For fitting, measure along one side of the head, as indicated by the dashed line above.

Deluxe Chinstrap



Size	Item#
26in	CS004S
28in	CS004L

Compare to
 Resprionics Deluxe
 OEM# 302425
 HCPCS# A7036

- Attaches to itself at the top of the head, two smaller support straps keep the system in place
- Extra-wide strap distributes pressure to add comfort

Comfort Chinstrap



Item# **CS005**
 Compare to
 ResMed Sullivan
 OEM# 16015
 HCPCS# A7036

- One size fits most
- Easy to use —Attaches to itself at the top of the head
- Soft cloth chin cup adds comfort

Premium Chinstrap



Item# **CS006**
 Compare to
 Resprionics Premium
 OEM# 1012911
 HCPCS# A7036

- One size fits most
- Attaches to itself at the top of the head to keep the chin lifted. Smaller support strap attaches to a split section of the chinstrap and wraps around the head for added stability.

SUNSET CHINSTRAPS AND HEADGEAR

All chinstraps and headgear are latex-free • Hand wash only • Lay flat to dry

Ruby Style Chinstrap

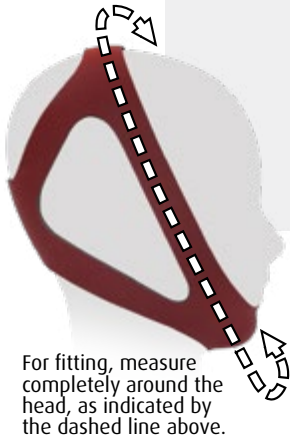

Size	Item#
21.5-22.5in	CS007S
22-23in	CS007M
23-24in	CS007L

Compare to Puresom Ruby
OEM# TMS-09 • HCPCS# A7036

- One piece stretches to slide over the top of the head — no need to Velcro
- Can be used with any nasal mask or pillows

Halo Style Chinstrap



Item# **CS025**
Compare to BreatheWear Halo Chinstrap
OEM# H3407
HCPCS# A7036

Ruby Style Adjustable Chinstrap



Size	Item#
Regular	CS007-ADJ
Extra Large	CS007-ADJXL

HCPCS# A7036

- Fully adjustable
- Super soft materials for extra comfort



Universal Mesh Headgear



Item# **HG001**
Compare to Respirationics SimpleStrap Headgear
OEM# 302328
HCPCS# A7035

- One size fits most
- Can be used with most 4-point nasal or full face masks

Universal Headgear



Size	Length	Item#
Regular	22.5in	HG003
Extra Large	24.5in	HG003XL

HCPCS# A7035

- Can be used with most 4-point nasal or full face masks

CLEANERS AND ACCESSORIES

Sunset Cleaning Wipes — Flowpack

Item#
CAP1003S

12/case
Flowpack of 64 wipes

- Ingredients are safe and gentle for daily cleaning of all types of CPAP and oxygen masks



Private Label CPAP Wipes

Order the flowpack wipes with your logo and contact info on a lid sticker, with a minimum quantity commitment. Talk to your sales rep for more info.



Cleaning Wipes — Single Packs

Item#
CAP1005S
Sunset Box of 30 single-pack wipes
Each

CAP1005
Citrus II Box of 12 single-pack wipes
12/case

- Convenient individually wrapped wipes are great for patient samples or travel use



CPAP Tube Cleaning Brush

Size	Item#
Standard 6ft	CAP1013
Slim 6ft	CAP1013SS

- Brushes all the way through a 6ft CPAP tube without leaving debris in the middle
- Stainless steel wire and soft nylon bristles

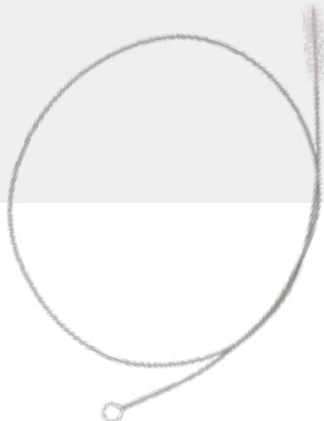

CleanSmart CPAP Disinfectant Spray

Item#
CAP1018-L
16oz • **6/case**

CAP1018-S
2oz • **9/case**

NEW

- Kills 99.9% of viruses & bacteria
- Included on the EPA's List N: Disinfectants for Use Against SARS-CoV-2
- Active ingredient Hypochlorous Acid does not leave a chemical residue
- EPA Registration Number 89896-2
- Formulated for disinfecting surfaces of external medical equipment and external surfaces of respiratory equipment



Citrus II Cleaning Wipes

Item# **CAP1003**
Canister of 62 wipes
12/case



Citrus II Mask Cleaning Spray

Item# **CAP1001**
1.5oz • **24/case**

- All-natural cleanser for daily mask cleaning
- Available in 1.5oz travel size or 8oz non-aerosol spray cans

Item# **CAP1002**
8oz • **12/case**



Citrus II Concentrate

Item# **CAP1004**
32oz • **Each**

- Formulated for weekly cleaning of tubing and accessories
- Mix 4oz of concentrate with 1 gallon of water



Filter Replacement Kit for SoClean 2

Item# **CAP1007S-KIT**
Each

- With filter, check valve, retail packaging and instruction manual
- Replace every 6 months



ZOEY CPAP CLEANER

Zoey CPAP Cleaner

Item# **ZCD100**

Each



Comes with

- Main unit
- Tube connector (for cleaning machine, mask, and tube)
- Ozone plug adapter (for cleaning mask and tube only)
- Injection tube with check valve
- Filter
- Power adapter
- User manual

Sunset presents Zoey CPAP Cleaner, a new and stylish way for patients to clean CPAP equipment.

Zoey is a DME-exclusive item, and only available for patient purchase through providers. Sunset never sells directly to the end consumer.

Choose what to clean

Patients can clean their mask, tube, and machine, or just their mask and tube. Zoey gives them options.

Easy to use, quiet and sleek

Clean or set delay mode with a single button. With a small footprint and quiet operation, Zoey fits in the home.

O3 technology

Zoey cleans using contained activated oxygen.



Zoey Adapters and Accessories

ZCD100KIT	Filter and Check Valve Kit
CAP1016S	Zoey Quick Release Connector
ZCD100A-DS	Heated Tube Adapter for DreamStation/PR System One
ZCD100A-A10	Heated Tube Adapter Lid for ResMed AirSense 10
ZCD100A-S9	Heated Tube Adapter Lid for ResMed S9
ZCD100TC	Replacement Tube Connector (used when cleaning machine)
ZCD100A-P	Replacement Ozone Plug Adapter (used when not cleaning machine)
ZCD100IT	Replacement Injection Tube with Check Valve
ZCD100F	Replacement Filter
ZCD100PA	Replacement Power Adapter
POSZCD	Poster
CARDZCD	Rack Cards
ZCD100-DEMO	Nonfunctional Demo Unit



Visit cleanwithzoey.com
for more information
and marketing support

Visit www.sunsethcs.com



SOMNIFIX

Mouth Strips

Item#
CAP1017
1 Box
of 28 Strips



SomniFix® Strips reduce open-mouth snoring, and can improve sleep quality, even if patients don't snore.

SomniFix® Strips are non-invasive sleep aids that curb mouth breathing. Unlike chin straps, SomniFix Strips gently adhere to the lips and allow for natural jaw movement while keeping the lips closed to prevent mouth breathing. A smaller breathing vent allows partial airflow.

SNUGZ

Snugz CPAP Mask Liners

Item#
CAP7001
Machine-Washable Liners
for Most Full Face Masks
2/pack

CAP7002
Machine-Washable Liners
for Most Nasal Masks
2/pack



- 2 per pack, 90-day supply
- Machine washable
- Fits MOST nasal or full face CPAP masks (Not recommended for ResMed Mirage Quattro or Respirationics Amara View and Dreamwear)
- Blend of spandex, moisture-wicking polyester and lycra fibers
- Latex-free

Snugz is a machine washable, one-size-fits-most liner for CPAP masks that is designed to help reduce noisy leaks, prevent redness and irritation, and feel great against the skin. The liner helps to grip the skin and keep the mask in place around the nose and mouth, reducing the need for a chinstrap. The improved seal is especially beneficial for high-pressure/high-flow PAP patients and can reduce nightly sleep disturbances and AHI.

REMZZS CPAP MASK LINERS

RemZzzs CPAP Mask Liners

Item#
CAP3001(S,M,L)
Liners for Full Face
ResMed & Respirationics

OEM#	K1-FS	SMALL
	K2-FM	MEDIUM
	K3-FL	LARGE

CAP3004(S,M,L)
Liners for Nasal ResMed
and Fisher & Paykel

OEM#	K10-NS	SMALL
	K11-NM	MEDIUM
	K12-NL	LARGE

30-Day Supply
Boxes sold individually.
Full face and nasal mask RemZzzs include 30 facial liners
and 2 forehead liners.

- Increases compliance by adding a comfortable and absorbent pad to CPAP mask
- Reduces air leaks and protects skin from red marks

CAP3002(S,M,L)
Liners for Full Face Fisher &
Paykel, Hans Rudolph, and
Sunset HCS

OEM#	K4-FS	SMALL
	K5-FM	MEDIUM
	K6-FL	LARGE

CAP3005L
Liners for Respirationics
FitLife Mask

OEM#	6A-FLK	SMALL AND LARGE
	6B-FLK	EXTRA LARGE



CAP3003(S,M,L)
Liners for Nasal
Respirationics

OEM#	K7-NS	SMALL
	K8-NM	MEDIUM
	K9-NL	LARGE

CAP3006
Liners for Nasal Pillows

OEM# 7A-NPK

CAP3007
Liners for Respirationics
DreamWear and Amara View

OEM# 6C-AVK



CPAP BATTERIES

- No additional adapters needed • Outlet functions like a wall socket
- Universal 110-240V recharging conversion • 1-Year Warranty

The Portable Outlet CPAP Battery

Item#
CAP1008

Includes battery, wall charger, and travel bag

Specs

- 2 USB ports (5V/2.1A)
- 2 lbs
- 7 x 5 x 1.75 in
- 155 Wh
- FAA/TSA compliant



Zopec Power Outlet 2

Item#
CAP1024-21ZDP02

Includes battery, wall charger, and travel bag

Specs

- 1 USB-C (45W) and 2 USB (5V/2.1A) ports
- 2.15 lbs
- 7.25 x 5 x 1.75 in
- 40,000 mAh /146 Wh
- FAA/TSA compliant

NEW



Zopec Explore 5700

Item#
CAP1024-2157

NEW

Specs

- 1 USB-C (5V/3A) and 2 USB (5V/2.1A) ports
- 2.6 lbs
- 8.5 x 6 x 1 in
- 54,200 mAh /160 Wh
- FAA/TSA compliant (carry-on only)



Zopec Explore 8200

Item#
CAP1024-2182

NEW

Specs

- 1 USB-C (5V/3A) and 2 USB (5V/2.1A) ports
- 3.5 lbs
- 7.75 x 5.5 x 1.75 in
- 80,000 mAh /288 Wh
- Not FAA/TSA compliant (exceeds power capacity)



Zopec Explore Batteries Include

- Universal Wall Charger
- Fast Car Charger
- Travel Pouch
- Run any electronics with power requirement of 120 watts or under
- AutoSwitch and Bypass Technology for uninterrupted sleep when power outages occur
- Unlimited linking of multiple batteries together for longer use before recharging

Visit www.sunsethcs.com

SUNSET
HEALTHCARE SOLUTIONS

CASH ITEMS

CPAP Pillows

Item# **CAP4003**

CPAPMax Pillow

Each OEM# 15-501R-1-920



CPAPMax Replacement Cover

CAP4003RC

Each OEM# 1-630-101-1-933

Replacement Pillow Case

CAP4003C

Each OEM# 1-626-900-1-02



Cool 3D Mesh Air-Flow
Reduces heat and perspiration



Fiberfill
Soft microfiber pillow top with hypoallergenic fiberfill

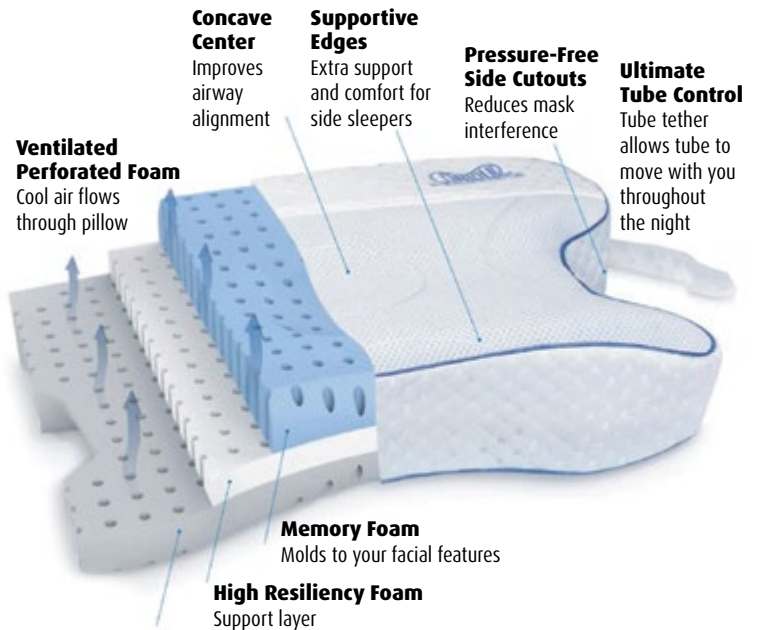

Ventilated Perforated Foam
Cool air flows through pillow

Concave Center
Improves airway alignment

Supportive Edges
Extra support and comfort for side sleepers

Pressure-Free Side Cutouts
Reduces mask interference

Ultimate Tube Control
Tube tether allows tube to move with you throughout the night

Memory Foam
Molds to your facial features

High Resiliency Foam
Support layer

Charcoal Infused High Resiliency Foam
Charcoal neutralizes odors for freshness every night

Item# **CAP4001**

CPAP Pillow

Each

OEM# 14-101R-1-730



CPAP Pillow Replacement Cover

CAP4001RC

Each OEM# 1-626-100-1-00

Replacement Pillow Case

CAP4001C

Each OEM# 1-626-800R-1-00

BEFORE

Traditional pillows interfere with mask performance and can cause a stiff neck, shifting, leaks, and facial discomfort.



AFTER

The CPAPMax Pillow offers superb mask accommodation, excellent support, and unparalleled comfort.



CPAP Bedside Storage Bag

Item# **CAP1015**



- Well-made and stylish
- Designed to hold CPAP supplies such as a mask and tube
- Weighted lid allows bag to hang off top of nightstand or tabletop



CPAP Holder

Item# **CAP1010**



- Sits between mattress and boxspring
- Saves space by allowing machine to rest in the area between bed and nightstand
- CPAP machine is kept close to patient's head, allowing more freedom to move throughout the night
- Keeps machine below mask, to help prevent rainout



CASH ITEMS

CPAP Moisture Therapy

Item# **CAP6100L**
1oz Tube • **18/cas**

- Formulated to prevent chafing, irritation, dryness or cracking from using a CPAP mask or other delivery device
- Apply to the face at the beginning of treatment and as needed
- Petroleum-free with aloe vera and vitamins A & E



CASH ITEM

Pur-Sleep CPAP Aromatherapy

Item# **CAP5001**
VaporClear Aromatherapy Starter Kit
OEM# VAPOR

Kit Includes:

- 1 aluminum diffusion stand
- 4 reusable diffusion pads
- 1.5ml bottle of Clear (peppermint, lime)
- 1.5ml bottle of Calm (eucalyptus, lavender, rosemary)



30ml Aromatic Refills

Scent/OEM#	Item#
Black Cherry	CAP5004-BCH
Calm	CAP5004-CLM
Clear	CAP5004-CLR
Dark Chocolate	CAP5004-DCH
Deep	CAP5004-DEE
French Vanilla	CAP5004-FRV
Fresh	CAP5004-FSH
Peace	CAP5004-PCE
Spice	CAP5004-SPC
Strawberry	CAP5004-STR

Item# **CAP5002**
Reusable Diffusion Pads
10/pack • OEM# DP10

Item# **CAP5003**
Replacement Aluminum Diffusion Tray
Each • OEM# TRAY

- Aromatherapy products specifically for use with CPAP
- Set up the diffuser right below the CPAP filter intake, add a drop of essential oil to the pad and the fragrance is drawn into the CPAP machine



H2Doze Distilled Water for CPAP

Item# **CAPH20-6**
16.9oz Bottles
6/pack

- TSA cleared bottle when accompanied with CPAP machine
- Convenient 16.9 oz bottle perfect for travel
- Enough water for multiple nights of use
- Distilled water designed to protect CPAP equipment
- Allows patient to breathe healthy, safe air throughout the night



Quick Tube Release Connector

Item# **CAP1016**
Each

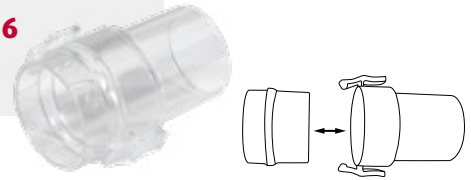

CPAP Final Bacteria Filter

Item# **BF2200**
22mm Bacteria Disk Filter
5/pack



Attach between the machine and tube for additional protection against bacteria and allergens

Circuit Connectors

Item# **RES013**
22mm OD x
15mm ID/
22mm OD
10/pack



Item# **RES014**
22mm OD x
22mm OD
With Lip
10/pack



Humidifier Tubing Adapter

Item# **RES016**
22mm ID x
22mm OD
with Lip
10/pack



Oxygen Bleed-In Adapter

Item# **RES019**
22mm with
6mm Stem
10/pack



- Barbed rotating stem
- Used for oxygen bleed-in

Swivel Connector Silencer

Item# **VEN002**
For CPAP and
Ventilator Circuits



Visit www.sunsethcs.com



TUBING WRAPS

Comfort Tubing Wrap



Item#
CAP2001
6ft Velour
Tubing Wrap
Each
Compare to
Respironics
Tubing Wrap

- 6ft plush velour material adds comfort while preventing rainout
- Zipper closure for ease of use

Both Tubing Wraps come in attractive retail packaging



Deluxe Tubing Wrap



Item#
CAP2002
6ft Nylon
Tubing Wrap
Each
Compare to ResMed
Tubing Wrap

- 6ft nylon wrap with fleece lining maximizes heat retention and reduces noise
- Zipper closure for ease of use

CPAP HCPCS AND REPLACEMENT SCHEDULE

HCPCS	Item	Recommended replacement schedule
A4604	Heated Circuit Tubing	1 per 3 months
A7027	Combination Oral/Nasal Mask	1 per 3 months
A7028	Replacement Oral Cushion for Combination Oral/Nasal Mask	2 per month
A7029	Replacement Nasal Pillows for Combination Oral/Nasal Mask — Pair	2 per month
A7030	Full Face Mask	1 per 3 months
A7031	Replacement Full Face Mask Cushion or Liner	1 per month
A7032	Replacement Nasal Cushion or Liner	2 per month
A7033	Replacement Pillows — Pair	2 per month
A7034	Nasal or Pillows Mask	1 per 3 months
A7035	Headgear	1 per 6 months
A7036	Chinstrap	1 per 6 months
A7037	Tubing	1 per 3 months
A7038	Filter — Disposable	2 per month
A7039	Filter — Nondisposable	1 per 6 months
A7044	Oral Interface	
A7045	Replacement Exhalation Port	
A7046	Replacement Water Chamber	1 per 6 months
A9279	Monitoring Feature/Device	
E0470	BiLevel Device without Backup Rate	
E0471	BiLevel Device with Backup Rate	
E0561	Humidifier - Non-Heated	
E0562	Humidifier - Heated	
E0601	CPAP Device	

Due to the rapid changes in reimbursement, this information is for reference only. Sunset Healthcare Solutions cannot guarantee its comprehensiveness or accuracy. Sunset urges you to contact a reimbursement specialist for up-to-date information and advice.

We can cross-reference any OEM numbers for you. This is just one of our many free services to help make doing business easier. We're always glad to talk, so give us a call today.

RoEzIt AND CPAP MOISTURE THERAPY



Item#
RES6104L
1oz Tube
18/case

Item#
CAP6100L
1oz Tube
18/case

- Prevent chafing, irritation, dryness or cracking from using a CPAP or oxygen delivery device
- Apply to the face at the beginning of treatment
- Petroleum-free with Aloe Vera and Vitamins A & E

Visit www.sunsethcs.com

**SUNSET**
HEALTHCARE SOLUTIONS

Oxygen	Page
Firesafe	34
Masks	35
Pulse Oximeters	35
Cannula	36-37
Tubing	37
Water Traps	37
Regulators and Conserver	38
Cylinder Carriers	40-41
Connectors and Adapters	42
Accessories	43-44
Cleaners	44
Bacteria and HEPA Filters	45
Concentrator Cabinet Filters	46-51
Caire/AirSep/Sequal	46
CHAD	47
Covidien Nellcor Puritan Bennett	47
DeVilbiss/Drive	48
Inogen	49
Invacare	49
Nidek	50
3B	50
Respironics/Healthdyne	51

OXYGEN PRODUCTS

FIRESAFE

Firesafe Thermal Shut-Off Valve

Item#
RES010
Each

• Bidirectional



CASH ITEM

- A thermal fuse designed to stop the flow of gas in the event that the downstream oxygen tubing is ignited
- Helps protect against oxygen tubing fires
- Helps keep patients safe no matter what method of oxygen delivery they use
- Offers a cost-effective solution to lower the risk of serious patient injury in an oxygen fire

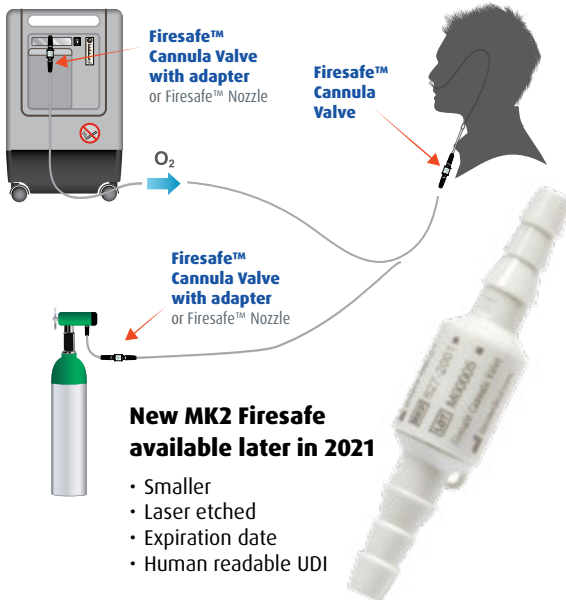

New MK2 Firesafe available later in 2021

- Smaller
- Laser etched
- Expiration date
- Human readable UDI

FireSafe Kits

Item#
RES010KIT
2 Firesafe Valves
1 Tubing Connector

Item#
RES010CANNULAKIT
2 Firesafe Valves
1 Tubing Connector
1 Adult Soft Cannula



FireSafe Tubing Connector

Item#
RES010TC 100/case
RES010TC-10 10/case



FireSafe Nozzle

Item#
RES010FND-20
20/pack



MASKS

Simple O₂ Mask



With 7ft Safety Tubing

Item# **RES2100**
Adult Size
50/case

Item# **RES2200**
Pediatric Size
50/case



HCPCS# A4620

- 5-12 LPM
- Medium concentration
- Clear, soft vinyl for patient comfort
- Adjustable nose clip for secure seal

Partial Rebreather O₂ Mask



With 7ft Safety Tubing & Reservoir Bag

Item# **RES2101V**
Adult Size
50/case

Item# **RES2201V**
Pediatric Size
50/case



HCPCS# A4620

- 5-15 LPM
- High concentration

Non-Rebreather O₂ Mask



With 7ft Safety Tubing & Reservoir Bag

Item# **RES2102**
Adult Size
50/case

Item# **RES2202V**
Pediatric Size
50/case



HCPCS# A4620

- 10+ LPM
- Low-resistance check valves prevent rebreathing and allow exhaled gas to escape

PULSE OXIMETERS

Advanced Finger Pulse Oximeter

Item# **RES5101**
Each



- 6 display modes
- Dual color OLED display
- SpO₂, PR, pulse bar and waveform



CASH ITEM

Both Pulse Oximeters

- 2-year warranty
- Ergonomic design
- Adult and pediatric use
- Low power consumption — automatically powers off
- Easy and convenient to operate and carry
- More than 30 hours of operation on 2 AAA batteries — included
- Light and compact



Both Pulse Oximeters come in attractive retail packaging

Standard Finger Pulse Oximeter

Item# **RES5100**
Each



CASH ITEM

- 1 display mode
- Digital LED display
- SpO₂, PR, and pulse bar



OXYGEN MASKS AND FINGER PULSE OXIMETERS

OXYGEN CANNULA

Cannula with Tubing

Adult Cannula with Tubing

Length	Material	Item#	Qty
4ft	Standard	RES1104	50/case
4ft	Soft	RES1104S	50/case
7ft	Standard	RES1107	50/case
7ft	Soft	RES1107S	50/case
15ft	Standard	RES1115	50/case
25ft	Standard	RES1125	25/case
25ft	Soft	RES1125S	25/case

HCPCS# A4615



- Clean, fresh look
- 1-6 LPM
- Curved nasal prongs for added comfort
- 6-channel safety tubing designed to prevent kinks
- Soft, lightweight material is memory free for long-term comfort

Item#

RES1207V

Pediatric Cannula
with 7ft Supply Tube
50/case



RES1307V

Infant Cannula
with 7ft Supply Tube
50/case



High Flow Soft Cannula

Length	Item#	Qty
4ft	RES1104SHF	25/case
7ft	RES1107SHF	25/case
15ft	RES1115SHF	25/case
25ft	RES1125SHF	25/case

HCPCS# A4615

- Now softer
- 6-15 LPM
- Maintains saturation for high-flow patients without a mask
- 6-channel supply tubing for safety



Cannula without Tubing

Adult Cannula without Tubing

Port	Material	Item#	Qty
Male	Standard	RES1100	50/case
Male	Soft	RES1100S	50/case
Female	Soft	RES1100FS	50/case

HCPCS# A4615

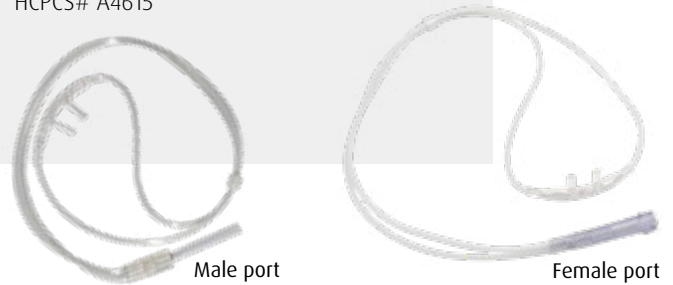

Soft Cannula with Universal Connector

Item# **RES1107SUC**

Adult Soft Cannula with
Universal Connector
and 7ft Supply Tube
50/case

HCPCS# A4615



Dual-Lumen (Demand) Cannula

Length	Item#	Qty
4ft	RES4144V	25/case
7ft	RES4147V	25/case

HCPCS# A4615

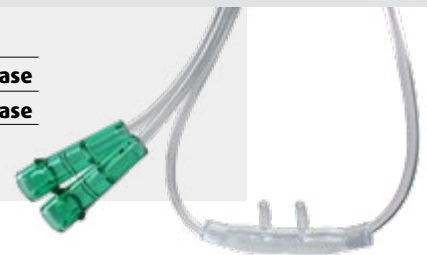

- 1-6 LPM
- Designed for use with dual port oxygen conservation delivery systems
- Dual tubing set provides independent tubes for oxygen delivery and sensing of patient breathing
- Smoothbore tubing

Tabbed Cannula

Item# **RES1007V**

Adult Tabbed Cannula
with 7ft Supply Tube
50/case

HCPCS# A4615



OXYGEN CANNULA, TUBING, AND WATER TRAPS

Secure Cannula Stickers

Item# **RES080**
25 pairs/case

- Holds cannula in place
- Easy to use
- Flexible, sheer fabric
- Designed to let skin breathe and peel off without leaving residue
- Latex-free
- Individually wrapped pairs

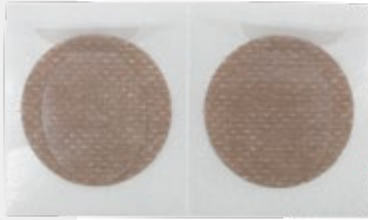

Comfort Cannula with Ear Cushions

Item# **RES1107EC**
7ft Cannula with
Ear Cushions
25/case
HCPCS# A4615



- 1-6 LPM
- Soft foam cushions add comfort and increase patient satisfaction
- Cushions are added during the manufacturing process so they stay in place and no assembly is required

Item# **RES020**
Cushions Only
50 Pairs/case

- Add cushions to existing cannula



OXYGEN TUBING

Oxygen Supply Tube



Length	Item#	Qty
7ft	RES3007	50/case
15ft	RES3015	50/case
25ft	RES3025	25/case
40ft	RES3040	20/case
50ft	RES3050	20/case

HCPCS# A4616

Oxygen Supply Tube — Green



Length	Item#	Qty
7ft	RES3007G	50/case
15ft	RES3015G	50/case
25ft	RES3025G	25/case
40ft	RES3040G	20/case
50ft	RES3050G	20/case

HCPCS# A4616

- Crush resistant with low memory to prevent kinking
- Great durability and comfort level
- Latex-free
- 1-6 LPM
- 6 channels

Water Traps

Item# **RES037**
Push On End Caps • **Each**

Item# **RES037T**
Threaded End Caps • **Each**

NEW



- Keeps water out of cannula
- Connects between cannula and supply tubing
- Removable end caps allows drainage of accumulated water
- 9cc water capacity in horizontal position

Visit www.sunsethcs.com

SUNSET
HEALTHCARE SOLUTIONS

OXYGEN REGULATORS AND CONSERVER

Mini Oxygen Regulator CGA 870 Style



"T" Handle for easy mounting — no tools needed

Barbed hose outlet for easy connection to the oxygen tubing

For use with E size or smaller cylinders: A, B, C, D, JD, E, M2, M4, M6, ML6, M7, M9, M15, M22, or M24.

Item# **RES042**
Adult • Barbed
0-8 LPM • **Each**
0, .5, 1, 1.5, 2, 2.5, 3, 4, 5, 6, 7, 8 LPM

Item# **RES043**
Adult • Barbed
0-15 LPM • **Each**
0, .5, 1, 1.5, 2, 3, 4, 5, 6, 8, 10, 15 LPM



Item# **RES046**
Pediatric • Barbed
0-4 LPM • **Each**
0, $\frac{1}{32}$, $\frac{1}{16}$, $\frac{1}{8}$, $\frac{1}{4}$, $\frac{1}{2}$, $\frac{3}{4}$, 1, 1 $\frac{1}{2}$, 2, 3, 4 LPM

HCPCS# E1353

Mini Oxygen Regulator CGA 540 Style



Threaded DISS outlet

For use with M60 and larger cylinders: M60, M90, M, MM, M122, M250, H, J, T or other cylinders with CGA 540 style valve.

Item# **RES044**
Adult • DISS
0-8 LPM • **Each**
0, .5, 1, 1.5, 2, 2.5, 3, 4, 5, 6, 7, 8 LPM

Item# **RES045**
Adult • DISS
0-15 LPM • **Each**
0, .5, 1, 1.5, 2, 3, 4, 5, 6, 8, 10, 15 LPM



Item# **RES047**
Pediatric • DISS
0-4 LPM • **Each**
0, $\frac{1}{32}$, $\frac{1}{16}$, $\frac{1}{8}$, $\frac{1}{4}$, $\frac{1}{2}$, $\frac{3}{4}$, 1, 1 $\frac{1}{2}$, 2, 3, 4 LPM

HCPCS# E1353

Both Regulators Feature

- Pressure gauge reads to 3000 PSI
- Easy-click flow selector knob
- 2-year warranty



Private label laser etching now available!

Ask your rep for details.

Oxygen Regulator CGA 540 Style Long Stem



Item# **RES045L**
Adult • DISS
0-15 LPM • **Each**
0, .5, 1, 1.5, 2, 3, 4, 5, 6, 8, 10, 15 LPM

Bonsai Pneumatic Conserver

Item# **RES049**
Single Lumen • Barbed Outlet
Each



- Delivers a uniform oxygen pulse at increments: 1, 2, 3, 4, 5, and 6
- Two continuous flow (CF) settings preset @ 2 LPM and 4 LPM
- Delivers up to a 6:1 savings ratio from 14-40 breaths per minute
- Senses breath/delivers oxygen in first half of inspiratory cycle
- Operating pressure range: 200-3000 PSI
- Light weight and quiet operation
- Easy to operate single selector knob
- Compact design fits easily in virtually any oxygen carry bag
- Limited 2-year warranty

Sample Oxygen Cylinder Specifications**

Use the handy chart below to determine which accessories to purchase for your oxygen cylinder.

* This information is intended to be used as a guide. Dimensions may vary by manufacturer. Sunset Healthcare Solutions does not sell oxygen tanks.



Older Name		A	B			C	D	JD	E		
Newer Name	M2	M4	M6	ML6	M7	M9	M15	M22	M24	M60	M/MM/M122
Diameter (in.)	2.5	3.2	3.2	4.3	4.3	4.3	4.3	5.3	4.3	7.3	8
Height (in.)	5.3	8.5	11.5	7.6	9.1	11	16.5	16.5	25.5	23	36
Empty Weight (lb)	0.7	1.6	2.2	2.8	3.3	3.7	5.3	8	7.9	22.3	39.5
Capacity (L)	42	113	164	165	198	255	425	640	680	1738	3455
Transport Method	CSBM6, CSBM6BP	CSBM6, CSBM6BP	CSBM6, CSBM6BP, CSBM6Flex, CSBM6-Carrier	CSBML6M7, CSBML6-Handshell	CSBML6M7	CSBM9, CSBM6BP, CSBM6Flex, RES038B	CSBD, CSBDBP, CSBD1Roller, CSBD2Roller, RES038B, RES060		CSBE, CSBD1Roller, CSBD2Roller, RES038B, RES060	Not Portable	Not Portable
Regulator Type	RES042, RES043	RES042, RES043	RES042, RES043	RES042, RES043	RES042, RES043	RES042, RES043	RES042, RES043	RES042, RES043	RES042, RES043	RES044, RES045	RES044, RES045

OXYGEN HCPCS

A4615	Cannula, nasal
A4616	Oxygen tubing, per foot
A4620	Oxygen mask, variable concentration
E0424	Stationary compressed gaseous oxygen system, rental
E0431	Portable gaseous oxygen system, rental
E0443	Portable oxygen contents, gaseous (for use only with portable gaseous systems when no stationary gas or liquid system is used), 1 month supply = 1 unit
E0445	Oximeter device for measuring blood oxygen levels non-invasively
E0560	Humidifier, durable for supplemental humidification during IPPB treatment or oxygen delivery
E1353	Oxygen supply regulator
E1354	Oxygen supply wheeled cart
E1355	Oxygen supply stand/rack
E1390	Oxygen concentrator, single delivery port, capable of delivering 85% or greater oxygen concentration at the prescribed flow rate
E1391	Oxygen concentrator, dual delivery port, capable of delivering 85% or greater oxygen concentration at the prescribed flow rate
E1392	Portable oxygen concentrator, rental
K0738	Portable gaseous oxygen system, rental; home compressor used to fill portable oxygen cylinders; includes portable containers, regulators, flow meter, humidifier, cannula or mask and tubing

CYLINDER BAGS

Comfort Shoulder Bags

Cylinder	Item#
ML6/M7	CSBML6M7
C/M9	CSBM9
B/M6	CSBM6
D	CSBD

CASH ITEM

- Comfort flex shoulder strap
- Double zipper for easy access
- Machine washable



Flex 02 Bag

Item# **CSBM6Flex**
Reconfigurable Bag
for M6 and M9
Cylinders
Each

- Adjusts to 5 carrying modes

CASH ITEM



Backpack

Cylinder	Item#
B/M6/C/M9	CSBM6BP
D	CSBDBP

CASH ITEM



- Fully adjustable and comfortable backpack straps
- Machine washable
- Converts to either backpack or shoulder bag

Wheelchair/Scooter Carrier

Item# **CSBE**
For E Cylinders
Each

CASH ITEM



- Multi-part stabilizer straps for easy chair attachment
- Machine washable

CYLINDER CARRIERS

Single Tank Rolling Bag/Backpack

Item#
CSBD1Roller
For D/E Cylinders
Each



CASH ITEM



Double Tank Rolling/Shoulder Bag

Item#
CSBD2Roller
For D/E Cylinders
Each



CASH ITEM

• May also be used with shoulder strap



ML6 Hardshell Tote

Item#
CSBML6-Hardshell
For Homefill Cylinders
Each



CASH ITEM



Cylinder Rack

Item# **RES038B**
Each
For D, E, or M9 Cylinders —
Lightweight, Durable
Plastic Composite Rack



Oxygen Cylinder Carrier

Item#
CSBM6-Carrier
Each
Soft Polyester Tote
for M6 Cylinders



- Tote handles
- Padded shoulder strap
- Fastening strap for mobility
- Holds up to 8 M6 tanks

D/E Cart

Item#
RES060
4/case

- Accommodates one D or E tank
- Sturdy yet lightweight (4.18 LBS welded metal construction)
- Adjustable height handle with PVC grip
- Large EVA Foam wheels have just the right amount of resilience for good traction and maneuverability
- Elegant, grey satin finish
- Bottom fork rest with rubber caps

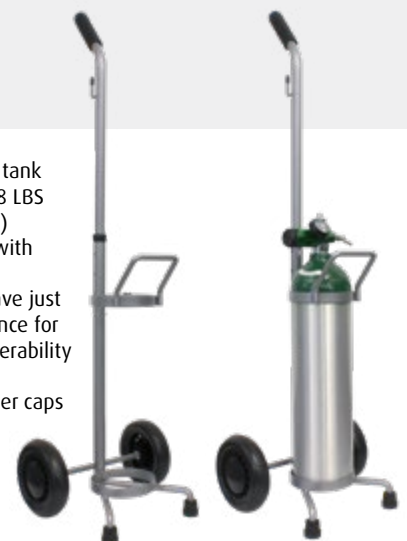

OXYGEN CONNECTORS AND ACCESSORIES

Christmas Tree Connector

Item# **RES001**
Green without Swivel
10/pack



Item# **RES002**
Green with Swivel
10/pack



- Tapered and barbed nut and nipple assembly allows secure tubing connections
- For standard DISS threaded oxygen outlets
- Improved threading is easier to connect to regulators or flow meters

Oxygen Accessory Kit

Item# **RES1000**
RES002 Christmas Tree Connector - Swivel
RES012 Tubing Connector - Non-Swivel
RES017 Tubing Y-Connector
RES018 Tubing Connector - Swivel
RES032 Wrench
RES035 Brass Washer

Each



CUSTOMIZABLE KIT



- Order all common oxygen accessories in one easy-to-handle kit
- Contents can be customized to fit your needs

Oxygen Tubing Y-Connector

Item# **RES017**
Fits 3/16in and 1/4in ID Tubing
(All 3 sides are the same)
10/pack



- Connects 2 oxygen sources for higher flows

Oxygen Tubing Connector — Non-Swivel

Item# **RES012**
Fits 3/16in and 1/4in ID Tubing
10/pack



- Barbed ends ensure secure, leak-free connections

Tubing Reducer Connector

Item# **RES011**
Fits 3/16in, 1/4in, 5/16in, 3/8in, and 7/16in ID Tubing
10/pack



- Tapered on both ends to connect multiple sizes of tubing, works with suction, oxygen, and catheter tubing

Oxygen Tubing Connector — Swivel

Item# **RES018**
Male/Male **10/pack**



RES018KIT-1
Female/Male **Each**



- Enhance patient mobility and comfort by minimizing twisting and tangling of oxygen supply tubing

Oxygen In Use Signs

Item# **RES003**
6in x 9in
With String
50/pack



- Double-sided (English and Spanish)

Washers with Rubber Ring

Item# **RES035**
Brass
25/pack



Item# **RES036**
Aluminum
25/pack



OXYGEN ACCESSORIES

O₂ Starter Kit

Item# RESO2KIT

- RES1107 Cannula with 7ft Tube x2
- RES3015 15ft Supply Tube x2
- RES002 Christmas Tree Connector — Swivel
- RES003 Oxygen In Use Sign
- RES012 Tubing Connector — Non-Swivel
- RES017 Tubing Y-Connector
- RES018 Tubing Connector — Swivel
- RES032 Wrench
- RES035 Brass Washer



CUSTOMIZABLE KIT

Disposable Bubble Humidifier 500 ml

Item#

RES050

Up to 15 LPM • 6 psi • 500 ml

20/case

HCPCS# E0560

OEM# HUM001



- Multi-threaded lid ensures a secure fit, preventing leaks and service calls
- Audible back pressure alarm activates at 6 psi
- No aluminum fitting in stem eliminates aluminum shreds often found in lower quality models
- Soft plastic diffuser reduces clogging due to mineral build-up
- Translucent jar provides improved visibility of jar contents
- Humidifier bottle lid is colored green/yellow, making it easy to tell patients on the phone how to change the bottle
- Bottle fill line is very easy to see
- Finger grips at the top of the bottle make the lid easier to screw on/off for the patient

Humidifier Connectors

Item# HUM008

L-Connector 12in • 10/pk

Item# HUM008L

L-Connector 21in • 10/pk

Item# HUM008S

Straight Connector 12in • 10/pk

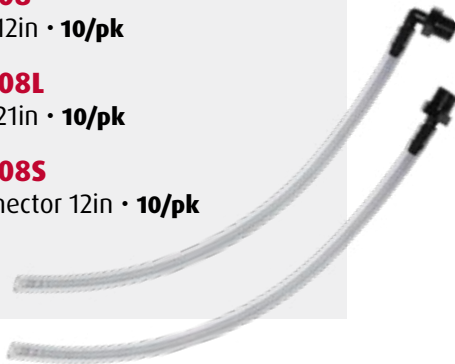

Disposable Bubble Humidifier 350 ml

Item#

RES053

Up to 15 LPM • 6 psi • 350 ml

50/case

HCPCS# E0560

OEM# 7600-0-50



- 360° rectangular diffuser ports provide quiet operation with low system back pressure and audible 6 PSI pop-off alarm
- Easy seal, translucent, double helix thread jar

Wrenches

Item# RES031

With Chain 10/pack

Item# RES032

Without Chain 10/pack

Item# RES031M

Metal Wrench with Chain for Post Valve Oxygen Cylinders and CGA 540 Style Regulators 5/pack



- For use with post valve oxygen cylinders: A, B, C, D, JD or E tanks
- Made of tough, stress-resistant nylon

Disposable Bubble Humidifier 350 ml

Item#

RES054

Up to 15 LPM • 6 psi • 350 ml

25/case

HCPCS# E0560

OEM# 7900-0-25



- 6psi safety valve

Visit www.sunsethcs.com



ACCESSORIES AND CLEANERS

Homefill Tubing Connector

Item# **RES039**
10/pack

- Compatible with Invacare, Drive, and Respirationics homefill machines
- Durable, coiled tubing



Homefill Racks

Item# **RES039-RACKB**
For Invacare Perfecto2
4/case

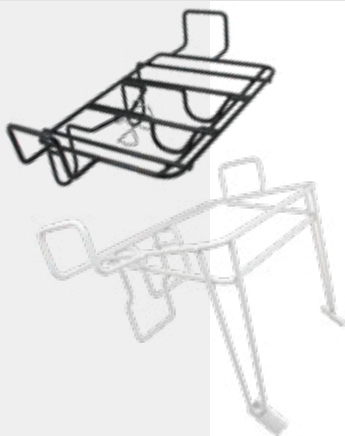

RES039-RACKW
For Invacare Platinum
4/case

RES039-RACKD
For DeVilbiss 525/1025 Series
4/case

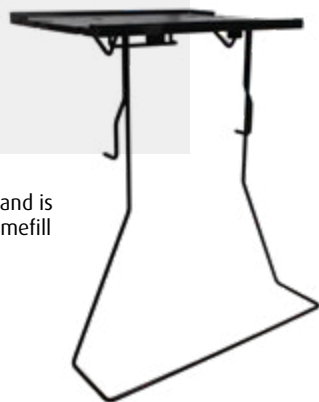

Easily attaches onto concentrator and is designed to conveniently hold Homefill and transfill oxygen systems.

Oxygen Liter Meter

Item# **RES034**
0-10 Liter/Minute
Each



- Oxygen pen
- Works with tanks and concentrators

RoEzIt Dermal Care

Item# **RES6104L**
1oz Tube • 18/cas



CASH ITEM

- Apply before beginning oxygen therapy and as needed during treatment
- Moisturizes the nose, lip, and over the ear where friction may cause discomfort from cannula
- Petroleum-free with aloe vera and vitamins A and E

Germicidal Deodorizing Cleaner

Item# **RES6100**
12/case
22oz spray bottles



- Heavy duty cleaner contains no bleach, alcohol, or phenols
- An effective bactericide, virucide, and fungicide
- Formulated to disinfect hard, non-porous surfaces

Germicidal Deodorizing Wipes

Item# **RES6101**
6/case
(Dispensers of 125 wipes)



- Cleans, disinfects, and deodorizes hard, non-porous surfaces
- Fresh citrus scent
- Kills 99.9% of bacteria

Germicidal Deodorizing Cleaner — Gallon

Item# **RES6102**
1 Gallon



- No-scrub, hospital strength germicidal cleaner
- Cleans, deodorizes, and disinfects surfaces, equipment and non-critical instruments

BACTERIA AND HEPA FILTERS

6in HEPA Capsule with Removable Sticker

Item# **BFH6S**
Threaded
Each



Intake Bacteria Filter

Item# **BF2222**
22mm fittings
5/pack



EverFlo Intake Filter

Item# **BF1001**
Each



Extended Life Bacteria Filter with Muffler

Item# **OF6011**
Each

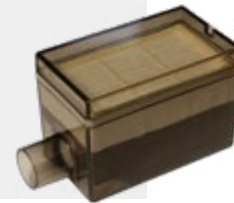

Extended Life Bacteria Filter

Item# **BF5000**
Nonthreaded
Each



Extended Life Intake Bacteria Filter

Item# **OF1025D**
Each



NEW

Extended Life Intake Bacteria Filter

Item# **BF1103**
Each

NEW



Final Bacteria Filter



Item# **BF516**
10/pack
5/16in Barbed
on Both Sides

Final Bacteria Filter — 1/4in to 3/8in

1/4in —
3/8in —

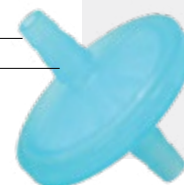

Item# **BF1438**
10/pack
1/4in to 3/8in
Stepped Barb
on Both Sides

Final Bacteria Filter — 1/4in to 1/2in

1/4in —
1/2in —



Item# **BF1412**
10/pack
1/4in to 1/2in Stepped
Barb on Both Sides

Final Bacteria Filter — 3/16in



Item# **BF316**
10/pack
3/16in Barbed
on Both Sides

CAIRE/AIRSEP/SEQUAL

CAIRE Companion 5



Item# **BF1103**
 Extended Life Intake
 Bacteria Filter
Each
 OEM# 2185



AirSep Newlife, QuietLife, Intensity



Item# **OF8002**
 Foam Cabinet Filter
10/pack
 5 1/4" x 4 7/8" x 7/8"
 OEM# F1-50-08-05



Item# **BF1438**
 Final Bacteria Filter
 1/4in to 3/8in
 Barbed
10/pack
 OEM# F1-30-03



Item# **OF8001**
 Felt Filter
10/pack
 17/8" OD x 3/4" ID x 1"
 OEM# M1 161-1



KIT

Item# **OF8002SP**
 Newlife Kit
 2 - OF8002
 1 - BF1438
 1 - OF8001
 Each

SeQual Integra



Item# **OF11005**
 Foam Cabinet Filter
10/pack
 7 5/8" x 3 5/8" - 5 x 3/4"
 OEM# 2185



Item# **OF11005SP**
 SeQual Kit
 2 - OF11005
 1 - BF5000
 1 - BF516
 Each

Item# **BF5000**
 Extended Life
 Bacteria Filter
Each
 OEM# 2033



KIT



Item# **BF516**
 Final Bacteria Filter
 5/16in Barbed
10/pack

SeQual Eclipse

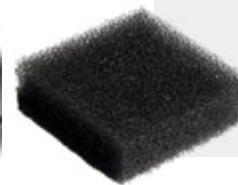

Item# **OF11006**
 Foam Cabinet Filter
10/pack
 2 1/2" x 2 1/2" x 3/4"

CHAD

Total O₂



Item# **OF11007**
Foam Cabinet Filter
10/pack
43/8" x 4" x 3/4"



Item# **BF2222**
Intake Bacteria Filter
22mm fittings
5/pack



KIT



Item# **OF3003**
Foam Intake Filter
for use with BF2222
10/pack
25/8" OD x 3/4" ID x 23/8"
OEM# H613

Item#
OF11007SP
CHAD Kit
2 - OF11007
1 - BF2222
1 - OF3003
Each

COVIDIEN NELLCOR PURITAN BENNETT

590 and 592A



Item# **OF6001**
Foam Cabinet Filter
10/pack
63/4" x 41/4" x 3/8"
OEM# 492672



Item# **BF5000**
Extended Life
Bacteria Filter
Each



KIT



Item# **BF316**
Final Bacteria Filter
3/16in Barbed
10/pack
OEM# 492141

Item#
OF6001SP
590 and 592 Kit
2 - OF6001
1 - BF5000
1 - BF316
Each

DEVILBISS/DRIVE

SolAiris III, 303 Series



Item#
OF5004SP
SolAiris III Kit
2 - OF5004
1 - BF1438
1 - BF5000
Each



KIT



Item# **OF5004**
Foam Cabinet Filter
10/pack
33/4" x 33/4" x 1/2"
OEM# 30302605



Item# **BF1438**
Final Bacteria Filter
1/4in to 3/8in Barbed
10/pack
OEM# MC29D-651



Item# **BF5000**
Extended Life
Bacteria Filter
Each

1025 Series



Item# **OF1025D**
Extended Life
Bacteria Filter
Each

NEW



Item# **OF5004**
Foam Cabinet Filter
10/pack
33/4" x 33/4" x 1/2"
OEM# 303DZ-605



Item# **BF1438**
Final Bacteria Filter
1/4in to 3/8in Barbed
10/pack
OEM# MC29D-651

SolAiris V, 505, 515 Series



Item#
OF5005SP
SolAiris V Kit
2 - OF5005
1 - BF6011
1 - BF1438
Each



KIT



Item# **OF5005**
Foam Cabinet Filter
10/pack
51/2" x 35/8" x 5/8"
OEM# 50502694



Item# **BF1438**
Final Bacteria Filter
1/4in to 3/8in
Barbed
10/pack
OEM# MC29D-651



Item# **BF5000**
Extended Life
Bacteria Filter
Each



Item# **OF6011**
Extended Life
Bacteria Filter
22mm fittings
Each
Use if SolAiris was
manufactured
before Nov '03

525 DS Series



Item# **OF5004**
Foam Cabinet Filter
10/pack
33/4" x 33/4" x 1/2"
OEM# 303DZ-605



Item# **BF1438**
Final Bacteria Filter
1/4in to 3/8in Barbed
10/pack
OEM# MC29D-651



Item# **OF6011**
Extended Life Bacteria
Filter — 22mm fittings
Each

All MC Units



Item# **OF5001**
Foam Cabinet Filter
10/pack
61/8" x 31/2" x 1/4"
OEM# 444-514



Item# **BF5000**
Extended Life
Bacteria Filter • **Each**



Item# **BF1438**
Final Bacteria Filter
1/4in to 3/8in Barbed
10/pack
OEM# MC29D-651



KIT

Item#
OF5001SP
MC Kit
2 - OF5001
1 - BF5000
1 - BF1438
Each

INOGEN

One



Item# **OF11008**
Foam Cabinet Filter
10/pack
2 1/4" x 3/4" x 1/2"
OEM# RP-100

INVACARE

Mobilaire 3 and 5



Item# **OF9001**
Foam Cabinet Filter
10/pack
6 3/4" x 3 3/8" x 1/2"
OEM# 2000489



Item# **BFH6S**
HEPA Filter
6in Capsule
Each
OEM# 2000806



Item# **BF516**
Final Bacteria Filter
5/16in Barbed
10/pack
OEM# P0750X030

Item#
OF9001SP
Mobilaire Kit
2 - OF9001
1 - BFH6S
1 - BF516
Each



KIT

Platinum 5 and 10



Item# **OF9002**
Foam Cabinet Filter
10/pack
9" x 2 7/8" x 1/2"
OEM#1107412



Item# **BFH6S**
HEPA Filter 6in
Capsule with Sticker
Each
OEM# 2000806



Item# **BF516**
Final Bacteria Filter
5/16in Barbed
10/pack
OEM# P0750X030

Item#
OF9002SP
Platinum Kit
2 - OF9002
1 - BFH6S
1 - BF516
Each



KIT

Perfecto₂



Item# **OF9004**
Foam Cabinet Filter
10/pack
6 7/8" x 3 3/4" x 1/2"
OEM# 1143492



Item# **BFH6S**
HEPA Filter 6in Capsule
Each
OEM# 2000806



Item# **BF516**
Final Bacteria Filter
5/16in Barbed
10/pack
OEM# P0750X030

Item#
OF9004SP
Perfecto₂ Kit
2 - OF9004
1 - BFH6S
1 - BF516
Each



KIT

HomeFill



Item# **OF9003**
Foam Cabinet Filter
10/pack
6 3/4" x 3 1/4" x 1/2"
OEM# F200489

NIDEK

Nuvo



Item# **OF11003SP**
Nuvo Kit
2 - OF11003
1 - BF1438
1 - BF5000
Each



KIT



Item# **OF11003**
Foam Cabinet Filter
10/pack
9 1/2" x 4" x 1/4"
OEM# 9250-1025



Item# **BF1438**
Final Bacteria Filter
1/4in to 3/8in Barbed
10/pack
OEM# 7631-1053



Item# **BF5000**
Extended Life
Bacteria Filter
Each
OEM# 9250-1028

Mark IV, V, V+



Item# **OF11004SP**
Mark Kit
2 - OF11004
1 - BF1438



KIT



Item# **OF11004**
Foam Cabinet Filter
10/pack
10" x 4" x 1/2"
OEM# 9007-6G37



Item# **BF1438**
Final Bacteria Filter
1/4in to 3/8in Barbed
10/pack
OEM# 7631-1053

3B

Stratus 5



NEW



Item# **OF6030**
Foam Cabinet Filter
10/pack
OEM# STR1030



Item# **BF6020**
HEPA Paper Filter
10/pack
OEM# STR1020

Item# **BF6040**
Bacteria Filter
10/pack
OEM# STR1040

RESPIRONICS/HEALTHDYNE

EverGo



Item#
OF1005SP
EverGo Kit
2 - OF1005
1 - BF316
Each



Item# **OF1005**
Foam Cabinet Filter
10/pack
2³/₁₆" x 1¹/₁₆" x 3³/₈"
OEM# 900-150



Item# **BF316**
Final Bacteria Filter
3/16in Barbed
10/pack
OEM# H621

EverFlo



Item#
OF1003SP
EverFlo Kit
1 - BF1001
1 - BF316
Each



Item# **OF1006SP**
Cabinet Filter Kit
(No Cover)
2 Filters, 1 Casing
OEM# 1055625



Item# **OF1006**
Cabinet Filter
10/pk
5¹¹/₁₆" x 4¹/₂" x 7⁷/₁₆"



Item# **OF1006-CASE**
Foam Cabinet Filter
Casing
10/pack



Item# **BF1001**
EverFlo Intake Filter
Each
OEM# 1038831



Item# **BF316**
Final Bacteria Filter
3/16in Barbed
10/pack
OEM# H621

Millennium



Item#
OF1001SP
Millennium Kit
2 - OF1001
1 - BF2222
1 - OF3003
1 - BF316
Each



Item# **OF1001**
Foam Cabinet Filter
10/pack
8¹/₄" x 4" x 3³/₈"
(3/16" notches)
OEM# H619



Item# **BF2222**
Intake Bacteria Filter
22mm fittings
5/pack
OEM# H620



Item# **OF3003**
Foam Intake Filter
for use with BF2222
10/pack
2⁵/₈" OD x 3³/₄" ID x 2³/₈"
OEM# H618



Item# **BF316**
Final Bacteria Filter
3/16in Barbed
10/pack
OEM# H621



Item# **OF1002**
Felt Filter
6/pack

Alliance



Item#
OF3002SP
Alliance Kit
2 - OF3002
1 - BF2222
1 - OF3003
1 - BF316
Each



Item# **OF3002**
Foam Cabinet Filter
10/pack
8¹/₄" x 3³/₄" x 1¹/₂"
OEM# 100-0078-10



Item# **BF2222**
Intake Bacteria Filter
22mm fittings
5/pack
OEM# 100-6631-00



Item# **OF3003**
Foam Intake Filter
for use with BF2222
10/pack
2⁵/₈" OD x 3³/₄" ID x 2³/₈"
OEM# H618



Item# **BF316**
Final Bacteria Filter
3/16in Barbed
10/pack
OEM# H621

OTHER

Other	Page
Aerosol	53
Compressor Nebulizers	54
Mesh Nebulizers	55
Nebulizer Kits	56
Nebulizer Filters	57
Suction	58-59
Tracheostomy	60
Ventilator Filters, Masks, and Connectors	61
Ventilator Circuits	62-63
Breast Pumps and Accessories	64
MADA Cleaners	65
Therapy and Comfort	66
Mobility	67
PPE	68-69

OTHER HCPCS

A6402	Gauze - sterile, pad size 16 sq. in. or less, without adhesive border, each dressing
A4483	Heat and Moisture Exchanger — Disposable
A4626	Tracheostomy Cleaning Brush
A4628	Oropharyngeal Suction Catheter (Yankauer)
A4629	Tracheostomy Care Kit - for established tracheostomy
A7000	Suction Canister — Disposable
A7002	Tubing for Suction Pump
A7003	Nebulizer Set - Small Volume—Disposable
A7005	Nebulizer Set - Small Volume—Nondisposable
A7013	Nebulizer Compressor Filter— Disposable
A7015	Aerosol Mask used with Nebulizer
A7525	Tracheostomy Mask
E0570	Nebulizer with Compressor
E0600	Respiratory Suction Pump - home model, portable or stationary, electronic
E2601	General Use Wheelchair Seat Cushion - width less than 22 inches, any depth

AEROSOL

Aerosol Mask

Item# **RES2110**
Adult Size
50/case

Item# **RES2210**
Pediatric Size
50/case

HCPCS# A7015

- Clear, soft vinyl for patient comfort
- Adjustable nose clip for secure seal
- Connector accepts 22mm aerosol tubing
- Individually packaged



Aerosol Tube

Item# **TUB100-6**
Corrugated Aerosol Tubing
100ft in 6in segments



Aerosol Tube — Blue

Item# **TUB100-6B**
Corrugated Aerosol Tubing — Blue
100ft in 6in segments



Drainage Bag with T-Adapter



Item# **RES070**
750cc • 50/case

- Designed to ensure patients receive mist rather than liquid accumulated in the tubing
- Includes hanger and bottom drainage port
- Works with 22mm corrugated aerosol tubing

Drainage Bag with Y-Adapter



Item# **RES071**
750cc • 50/case

SperaChamber

Anti-Static Valved Inhaler Chamber
for Metered Dose Inhaler
Each

Item#
RES095
Chamber Only

RES095MP
Chamber with Pediatric Mask Kit
(3-6 Years)

- Inhalation valve
- Universal adapter
- Spiral vents
- Seal with exhalation safety valve
- Latex-free and DEHP-free
- Dog mask appeals to kids



COMPRESSOR NEBULIZERS

Compressor Nebulizer and Sunny Pediatric Compressor Nebulizer

Item#

NEB100

- Disposable T-Piece Kit (RES091)
- Foam Filters (BF018 x5)

NEB100-R

- Disposable T-Piece Kit (RES091)
- Reusable T-Piece Kit (RES093)
- Foam Filters (BF018 x5)

NEB300BEAR

- Disposable Pediatric Mask (RES2210)
- Disposable T-Piece Kit (RES091)
- Foam Filters (BF018 x5)

NEB300BEAR-R

- Disposable Pediatric Mask (RES2210)
- Disposable T-Piece Kit (RES091)
- Reusable T-Piece Kit (RES093)
- Foam Filters (BF018 x5)



- Rust-resistant
- Quiet (below 60dBA)
- 6ml medication capacity
- Average nebulization rate above 0.2ml/min
- Particle size: respirable fraction 0.5 to 5um 0.5um 80%
- Compressor pressure range 30-45 PSI
- Operation pressure range 12-14 PSI
- Liter flow range 8-10 LPM



NEB100-BAG
Carry Bag

Basketball Pediatric Compressor Nebulizer

Item#

NEB300BASKETBALL-R

- Disposable Pediatric Mask (RES2210)
- Disposable T-Piece Kit (RES091)
- Reusable T-Piece Kit (RES093)
- Foam Filters (BF018 x5)

NEW



Sunset's Basketball Nebulizer brings some play to treatment time! The Basketball Nebulizer is packaged in a vivid and fun retail box that appeals to kids.

Handheld Compressor Nebulizer



Item#

NEB200

- Included**
- Compressor
 - Medication cup
 - AC power adapter
 - Air hose
 - Elbow
 - Mouthpiece
 - Mask
 - 4 AA batteries

- Runs on 4 AA batteries or AC power adapter
- Portable (small and weighs only 1/2 pound)
- Quiet (60dBA)
- Fine particle size (Approximately 3 microns)
- No replacement filter required

MESH NEBULIZERS

Flyp Pocket Portable Mesh Nebulizer

Item#
NEB500

NEW

Replacement parts

NEB500-HCART HypersonIQ Cartridge
NEB500-MP Mouthpiece
NEB500-DC Charger

- Unique all-in-one design, no external parts or attachments
- Simple to use: Fill, Click, Breathe
- Smaller, by volume and weight, than all competitors
- Truly portable and truly handheld, it fits the patient's life
- Powered by a USB rechargeable lithium ion battery
- High respirable fraction at 88-90%
- 3-year manufacturer's warranty
- HSA/FSA approved #9275



Extended battery
15-20 uses on average

Refined design
Including rounded mouthpiece for increased seal and comfort

Replaceable reservoir
Easier to open, and now fits two 3ml treatments comfortably

Now even faster
5-minute average treatment time

Better and easier maintenance
Pulse cleaning mode

Rechargeable Mini Mesh Nebulizer

Item#
NEB401

NEW

Included

Main unit
Medicine cup
Disposable mouthpiece
Disposable adult mask
Disposable pediatric mask
USB cord
Carrying bag
Instruction manual



Small particle size
MMAD 2.2µm*

Efficient
Low Residual Liquid

Convenient
Small and Portable

Quiet
≤50dB (at one meter)

Modern
Rechargeable Lithium Battery

Power Input USB (5VDC Min 1.5A)
Rechargeable Lithium Battery 3.7VDC 1800mAh
Frequency 110KHz±10%
Nebulization Rate ≥0.2mL/min
Sound Level ≤50dB (at one meter)
Medicine Liquid Temperature ≤140°F

Replacement Parts

NEB401-CUP	Medication Cup
NEB401-MP	Mouthpiece
NEB401-MASKP	Pediatric Mask
NEB401-MASKA	Adult Mask

Mini Mesh Nebulizer

Item#
NEB400

Included

USB cord
Medicine cup
Mouthpiece
Adult mask
Pediatric mask
Carrying bag

- Runs on USB or 2 AA batteries
- Quiet
- Fast treatment times
- Small particle size
- Attainable for more patients

Replacement Parts

NEB400CUP	Medication Cup
NEB400MP	Mouthpiece
NEB400MASKP	Pediatric Mask
NEB400MASKA	Adult Mask



NEBULIZER KITS

Disposable Nebulizer Kit with T-Piece

Item# **RES091**
Disposable
Single Patient
50/case

HCPCS# A7003

- Includes:
- 6cc jet nebulizer bottle
 - T-piece with mouthpiece and corrugated reservoir tube
 - 7ft supply tube

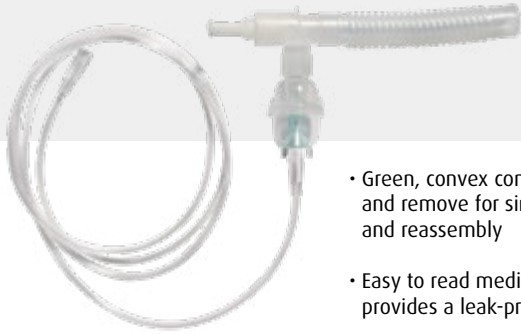

- Green, convex cone is easy to see and remove for simple cleaning and reassembly
- Easy to read medication jar provides a leak-proof seal

Reusable Nebulizer Kit with T-Piece

Item# **RES093**
Reusable — Single Patient
10/case

HCPCS# A7005

- Includes:
- 10cc jet nebulizer bottle
 - T-piece with mouthpiece and corrugated reservoir tube
 - 7ft supply tube



- Latex-free
- Dishwasher safe
- High capacity (10cc)
- CC volume markings
- Very low residual volume (0.7cc)
- 1/4 turn cap provides leakproof seal
- Works upright or at angles up to 45°

Disposable Nebulizer Kit with Angled Mouthpiece

Item# **RES096**
Disposable
Single Patient
50/case

HCPCS# A7003



- Includes:
- 6cc jet nebulizer bottle
 - Angled mouthpiece
 - 7ft supply tube



Disposable Nebulizer Kit with Mask

Item# **RES090**
Adult Size
50/case

Item# **RES092**
Pediatric Size

HCPCS# A7003



- Includes**
- 6cc jet nebulizer bottle
 - T-piece with mouthpiece and corrugated reservoir tube
 - 7ft supply tube
 - Disposable single patient use for long term delivery procedures
 - 6cc bottle is easy to assemble and disassemble

NEBULIZER FILTERS

Plastic Intake Filter

Item# **BF015**
10/pack
 HCPCS# A7013



Plastic Intake Filter with Head

Item# **BF016**
10/pack
 HCPCS# A7013



Plastic Intake Filter with Head

Item# **BF017**
5/pack
 HCPCS# A7013



Foam Filter

Item# **BF018**
10/pack
 HCPCS# A7013



Plastic Intake Filter for Respironics InnoSpire

Item# **BF026S**
10/pack
 HCPCS# A7013

- Mini
- MicroElite
- MiniElite



Nebulizer Filter Compatibility

Caire

Medi-Mist	BF018
-----------	-------

DeVilbiss

PulmoNeb	BF017
PulmoNeb LT	BF017
Sunrise Compact	BF018
Pulmo-Aide	BF017
Pulmo-Aide Compact	BF017
PulmoMate	BF017

Evo

AeroMax	BF018
SportsNeb	BF018
Super SportsNeb	BF018

Invacare

Passport	BF018
Envoy	BF018
Envoy Jr.	BF018
Select	BF018

John Bunn

Nebulite EV	BF018
LT2	BF018
LX	BF018

MedLine

SportsMist	BF018
------------	-------

Respironics

Inspiration 323	BF015
Inspiration 626 & 929	BF016
MisterNeb	BF016
Inspiration Elite	BF016
MiniElite	BF018
InnoSpire	BF026S

Salter

AIRE Plus	BF018
-----------	-------

Schuco

2000	BF018
3000	BF018

Sunset

NEB100 Series	BF018
NEB300 Series	BF018

SUCTION

Suction Machine

Item# **SU100DC**
With Internal Rechargeable Battery



SU100AC
Without Battery

Comes with
Machine
Carrying Bag
800cc Suction Canister
AC Adapter & Power Cord
1.5in Suction Tube Connector
10in Suction Tube Connector
6ft Suction Tubing
BF1312 Hydrophobic Inline Filter

- Effective removal of respiratory fluids
- Durable yet lightweight
- Variable vacuum control
- Quiet and easy to use
- Two-year warranty

Accessories and replacement parts

SU100DC-PA DC Mobile Power Adapter (for car power outlet)
SU100DC-Adapt Replacement Power Adapter (without cord)
SU100DC-Cord Replacement Power Cord (without adapter)
SU100DC-BAG Carrying/Storage Bag
SU100-PA Car Charger (DC Mobile Power Adapter)
SU100DC-BATTERY Internal rechargeable battery replacement

Suction Kit for SU100DC

Item# **RES026S-SS**
RES023S Suction Canister
RES024S Suction Tubing Connector 1.5in
RES024L10 Suction Tubing Connector 10in
BF1312 Bacteria Filter
RES025 Suction Tubing 1/4in x 6ft



HCPCS#
CANISTER - A7000
TUBING - A7002

Suction Filter Component Kit for SU100DC

Item# **RES024S-KIT**
RES024S Suction Tubing Connector 1.5in
RES024L10 Suction Tubing Connector 10in
BF1312 Bacteria Filter



SUCTION

Suction Canister

Item# **RES023S**
800cc • Single Use
10/case
HCPCS# A7000



- Float shut off valve for protection against overflow and premature shut-off
- Leak-free seal to minimize vacuum loss

Suction Kit

Item# **RES026S-E**
RES023S Suction Canister
RES024M Suction Tubing Connector 4.5in
RES025 Suction Tubing 6ft
RES028 Elbow Connector
BF3812 Bacteria Filter



HCPCS#
CANISTER - A7000
TUBING - A7002



Suction Machine Inline Filters

Item# **BF1312**
1/3in to 1/2in
1/pack



Item# **BF3812**
3/8in to 1/2in
10/pack



Item# **BF516TS**
5/16in Barbed with Threaded NPT
10/pack



NEW

SUCTION

Suction Tubing

1/4in

Length	Item#	Qty
18in	RES025S	50/case
6ft	RES025	10/case

3/16in

Length	Item#	Qty
18in	RES025-31618	100/case
20in	RES025-31620	100/case
6ft	RES025-31672	50/case

HCPCS# A7002



Suction Catheters

50/case

Size	Valve Type	Tip	Item#
8fr	Y	DeLee	TRASC108S
8fr	Chimney	DeLee	TRASC108SCV
10fr	Y	Whistle	TRASC110S
10fr	Chimney	Whistle	TRASC110SCV

- Sterile
- Single patient use
- Latex-free



Bulb Tip Yankauers

Item# **TRAA001S**
Vented • **50/case**

Item# **TRAA002S**
Non-Vented • **50/case**

HCPCS# A4628



- Sterile
- Single patient use
- Not made with natural latex rubber

Suction Tube Connectors

10/pack

Size	Item#
1.5in	RES024S
3.5in	RES024
4.5in	RES024M
6in	RES024L
10in	RES024L10
16in	RES024XL

NEW



Rubber Suction Elbow Connector

Item# **RES028**
6/pack



TRACHEOSTOMY

Tracheostomy Mask

Item#
RES2130
Adult Size
50/case

RES2230
Pediatric Size
50/case

HCPCS# A7525



- Latex-free
- 360° swivel in 2 places allows access from either side of the patient
- Comes with removable adapter to fit with aerosol or O₂ supply tubing

HMEs

Heat Moisture Exchangers

	RES027FLEX Flex HME — Foam	RES027 T-HME	RES027OP T-HME with Oxygen Port	RES027IL Inline HME — Large Volume	RES027NE Inline HME — Neonatal
TV Range (mL)	300-1500	250-1000	250-1000	15-50	15-50
Moisture Output (mg H ₂ O/L)	33.8, Vt = 0.5L	27.3, Vt = 0.5L	26, Vt = 0.5L	31, Vt = 0.1L	30, Vt = 0.2L
Weight (g)	17	5	6.5	10	5
Resistance (cm H ₂ O)	0.5@30 LPM, 1.34@60 LPM	0.7@60 LPM	0.4@30 LPM	0.4@10 LPM	0.5@10 LPM
Dead Space (mL)	90	12.5	12	13	2.5
Connection (mm)	22M, 15F	15F	15mmF, 5.5mm Oxygen port	15M, 22M/15F	15M, 15F

Tracheostomy Swivel Elbow Connectors

15mm ID x 15mm OD
10/pack



Adapter for T-HME

Item# **RES027A**
Each



Tracheostomy Ties with Fastener Tabs

20/case

One-piece
• Easy on

Item#
RES029 Adult
RES029P Pediatric

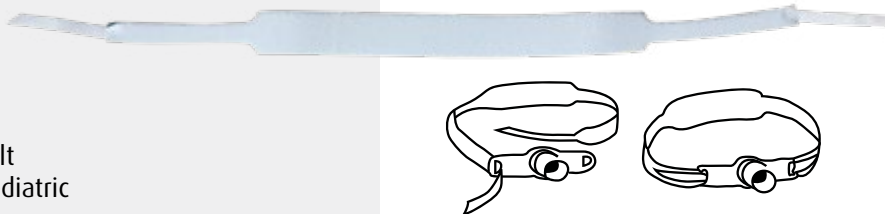

- Designed to provide secure stabilization of the tracheostomy tube
- Made from soft foam and cotton

Two-piece
• Easy off

Item#
RES030 Adult
RES030P Pediatric



VENTILATOR FILTERS, MASKS, AND CONNECTORS

Bacterial/Viral HME Filter — Adult

Item# **BF104**
 15 mm ID x 15 mm ID/
 22 mm OD
Each
 HCPCS# A7507



- Bacterial efficiency 99.9999+%
- Viral efficiency 99.99+%
- Gas sampling port
- 35.5mg/L @ 500ml VT

Bacteria Filter

Item#
BF2200
 22mm Bacteria
 Disk Filter
5/pack



Ventilator Felt Filter

Item#
VF006
 For use with
 NPB LP6 & LP10
10/pack



Respironics Trilogy Ventilator Filter

Item#
CF1009F
2/pack
 OEM# 1029330



Valved T-Adapter — Adult

Item#
VEN001
 22F-18F-22M/15F
Each



NIV Mask with Headgear — Non-vented

Each
 Item#
CM038M Medium
CM038L Large

NEW



- Disposable, single patient use
- PC frame with PVC air cushion seal
- Low dead space for low CO2 buildup
- Clear mask allows a good view of mouth and nasal area
- Headgear with Velcro fasteners provide maximum versatility and movement
- Dual 360 degree swivels at the mask attachment and at the standard 22mm tubing attachment point

Swivel Connector Silencer

Item#
VEN002
 For Ventilator Circuits and CPAP
Each



Fixed Exhalation Port

Item#
VEN003
 For Ventilator Circuits and CPAP
 22 mm OD x 15 mm ID
Each

NEW



Circuit Connectors

Item#
RES013
 15mm ID x 22mm OD
10/pack

RES014
 22mm OD x 22mm OD
10/pack



VENTILATOR FILTERS, MASKS, AND CONNECTORS

VENTILATOR CIRCUITS WITHOUT HUMIDIFIER CHAMBER

Passive Heated Breathing Circuit

Item#
VC1114

For use with MR850 Humidifier
10/case
OEM# RT1114

NEW

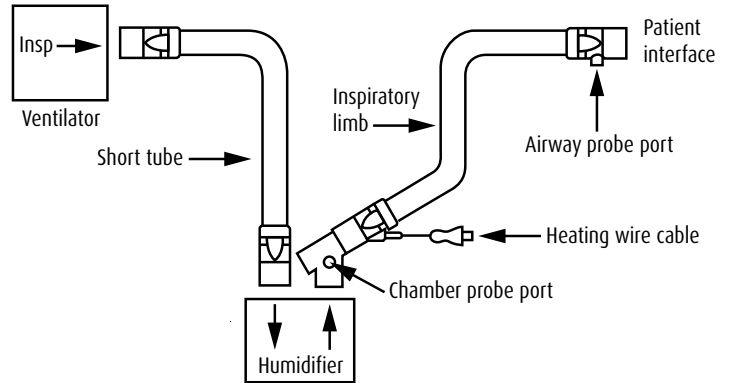

Passive Non-Heated Breathing Circuits

For use with Respiroinics Trilogy

Item#
VC1000

With swivel exhalation port
Each
OEM# 1073228 & 1073236

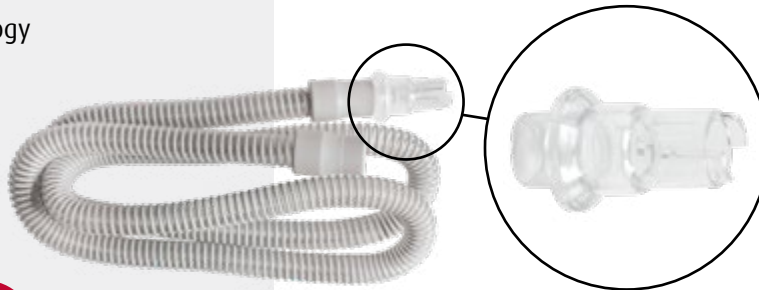

NEW

VC1100

With fixed exhalation port
Each
OEM# 1069467 & 1069468

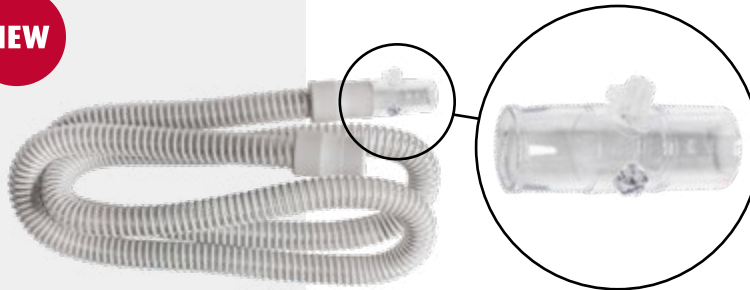

Corrugated Tubing — 100ft in 6in Segments

Item#

TUB100-6
Clear



TUB100-6B
Blue

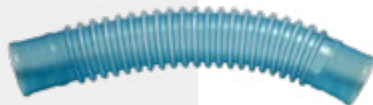

VENTILATOR CIRCUITS WITHOUT HUMIDIFIER CHAMBER

Non-Heated Breathing Circuits

For use with Respiration Trilog
22mm cuffs
30/case



Item#	OEM#	Mode	Water Trap	Size	Tube Diameter
VC1001	1073223 & 1073232	Active	No	Adult	22mm
VC1001P	1073220 & 1073229	Active	Yes	Pediatric	15mm
VC1004	1069443 & 1069444	Passive	Yes	Adult	22mm
VC1004P	1073224 & 1073233	Passive	Yes	Pediatric	15mm

Item#
VC1001
Active Adult
OEM#
1073223
1073232

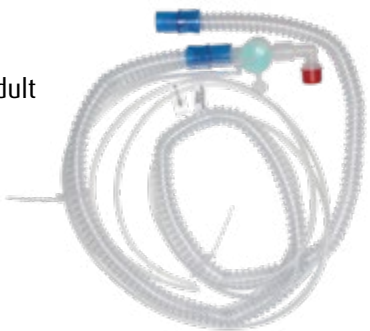

Item#
VC1001P
Active Pediatric
OEM#
1073220
1073229

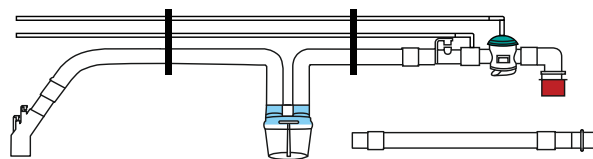
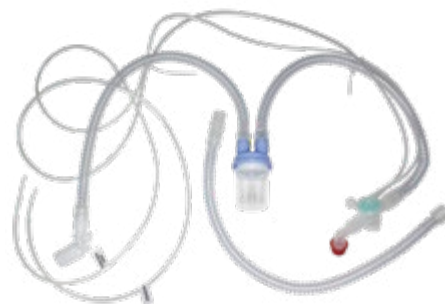

To use active circuits with Respiration Trilog, simply cut ends off pressure and exhalation lines.

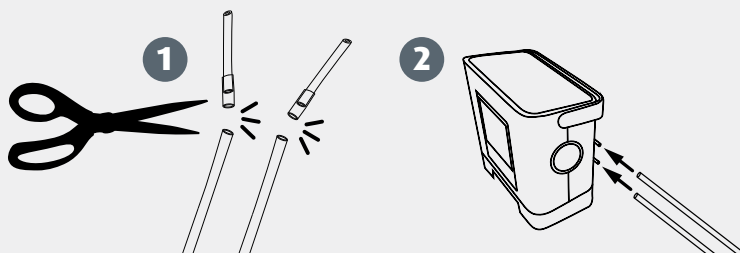

Item#
VC1004
Passive Adult
OEM#
1069443
1069444

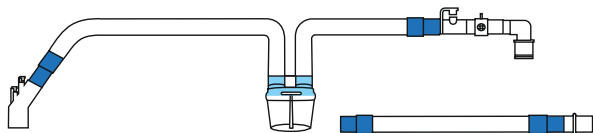

Item#
VC1004P
Passive Pediatric
OEM#
1073224
1073233

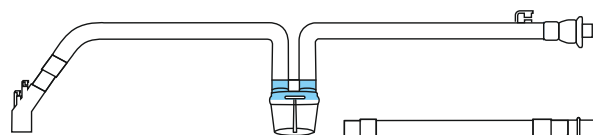

BELLEMA BREAST PUMPS

Single

Item#
MAT2201M1

- One pump for simplicity
- Can be powered by 4 AA batteries



Effective Pro IDC

Item#
MAT2210M2

- First in USA with IDC (independent dual control)
- No loss of suction power when both pumps are used



Plenitude

Item#
MAT2219M2

- All the features of the Plethora, with built-in rechargeable battery



Euphoria Pro IDC

Item#
MAT2212M2

- Independent controls for left and right pumps (IDC)
- No loss of suction power when both pumps are used
- With 3D: Designed to emulate real nursing
- Built-in rechargeable battery



All BelleMa Breast Pumps

- Quiet
- BPA-free
- Closed system
- Anti-backflow design
- Soft silicone cushions
- Adjustable, saveable settings
- Dual phase (stimulation and expression)

Contact Sunset for all replacement parts

Milk Storage Bottles

Item#
MATNP180K1
6/pk

- Bottle lids are made from high quality polypropylene polymer
- Heat-resistant up to 248°
- Designed for longer storage without losing the beneficial properties of breast milk
- 100% BPA-Free and safe to use
- Fits other standard size popular brand breast pumps



Accessories

Item#
MATRFD-130C/084
Disposable Breast Pads
84 Pads

Item#
MATD-2130M
Insulated Cooler Bag



MADA CLEANERS

Hospital-Grade Bactericide/Virucide/Fungicide

MADACide-1

Item#	Container
RES6106G	1 Gallon
RES6106S	32oz Spray



- Alcohol-free
- Disinfectant/cleaner/deodorizer
- Effective bactericide, virucide, and fungicide
- Formulated to disinfect hard, non-porous, inanimate, environmental surfaces, equipment, and non-critical instruments
- Kills Influenza A, HIV, Hepatitis A, B & C, TB, MRSA, VRE, and SARS
- General one-step, ready-to-use, hospital-grade product

MADACide-FD

Item#	Container
RES6107G	1 Gallon
RES6107S	32oz Spray
RES6107W	160 Wipes Canister



- Disinfectant cleaner/deodorizer
- Effective bactericide, virucide, germicide, and fungicide
- Formulated to disinfect hard, non-porous, inanimate, environmental surfaces, including chrome, glass, painted surfaces, plastics, and stainless steel
- Ideal for use with most medical surfaces such as operating rooms, respiratory therapy equipment, and medical instruments
- Unique anti-corrosion formulation will not damage lenses, cement, plastics, rubber, steel, aluminum, brass, or other metal when used as directed
- Kills Influenza A, HIV, Hepatitis B & C, TB, MRSA, VRE, and SARS

Steri-Fab

Item#	Container
RES6108G	1 Gallon
RES6108S	16oz Spray



Steri-Fab is a one-step ready-to-use disinfectant/insecticide that kills insects, fungus, germs, and odors on porous and non-porous inanimate surfaces.

Ideal for disinfecting and handling of rental beds, mattresses, linens, rugs, furniture, bedding, and veterinary kennels. Kills fleas, ticks, bed bugs, lice, ants, and roaches. 11-Way Protection includes: Virucide, Bactericide, Sanitizer, Fungicide, Insecticide, Deodorant, Germicide, Disinfectant, Mildewcide, Bacteriostatic, and Fungistatic.

Green Oxygenated Cleaner

Item#	Container
RES6105	1 Gallon Concentrate



- General indoor cleaner/degreaser
- Recognized for safer chemistry by the EPA
- Mild deodorizing scent from natural essence
- Free rinsing, leaves no residue
- Colorless
- Not for use on oxygen equipment

THERAPY AND COMFORT

Wireless TENS

Item#
TEN200
Each

Includes 2 reusable gel pads and USB charging cord

- Wireless
- USB-rechargeable internal battery
- 5 modes: Scraping, Massage, Beat, Acupuncture, Combination of all 4
- 15 intensity levels

TEN200-PAD
Replacement Gel Pads
4 Pairs



Phazix Pill Swallowing Gel

Item#
RES6109
6/case



- Phazix is a clear, moderately thick, slippery gel that is placed on a spoon with the medication and consumed in a single swallow
- Phazix lubricates the mouth and throat to smoothly carry medication to the stomach
- Phazix has an all natural, pleasant vanilla flavor and aroma to mask any unpleasant taste or smell of medications
- Phazix does not impact absorption rates and breaks down quickly in the stomach to maintain the therapeutic effect of the medication
- Easy to use, simply place the whole tablet, capsule, powdered or crushed medication on a teaspoon, cover with Phazix and swallow



SkinSmart Antimicrobial™ Spray

Wound Therapy

Item#
CAP1020-W
6/case



- Same active ingredient, hypochlorous acid, used in the other SimpleScience products
- Targets bacteria, the #1 problem in hard-to-heal wounds
- Ideal for skin ulcers associated with diabetes
- Made for hard-to-heal wounds, rashes, burns, boils—even bed sores
- Safely removes bacteria without irritating skin or open wounds
- Same formula used in wound clinics for foot ulcers and post-op recovery
- Alternative to traditional antiseptics, which can damage skin over time

Eczema Therapy

Item#
CAP1020-E
6/case



More than 70% of chronic eczema is linked to bacteria. SkinSmart safely removes bacteria—a critical step in healing.

- NOT another cream or lotion
- Stops itch (fast!)
- Clear and non-sticky
- Steroid-free and safe for all ages!

KNEE SCOOTER

Deluxe Knee Scooter

Item#

MOB100

Steerable, with basket

HCPCS# E0118



- Dual rear wheel brakes with parking brake feature
- Steerable
- Foldable for easy storage and transport
- Indoor/outdoor
- Adjustable height handlebar and knee pad
- Contoured knee pad
- Large 7in wheels

Replacement Parts

MOB100-WHEELS	Wheels (Pair)
MOB100-KNEEPAD	Knee Pad
MOB100-BRAKEHANDLE	Brake Handle
MOB100-BRAKECABLE	Brake Cable
MOB100-BASKET	Basket

Frame Warranty	3 years
All Other Components Warranty	1 year
Max Weight Capacity	350 lbs
Basket Max Weight Capacity	10 lbs
Brake System	Dual Rear Wheel Brakes
Wheel Size	7in
Handle Height	31in - 40in
Knee Pad Height	16.5in - 20.5in
Weight	22 lbs

The MOB100 Deluxe Knee Scooter provides an easy, portable way to keep up with daily activities after foot or ankle surgery, sprains, amputations or other leg impairments. It's equipped with a basket for transporting items up to 10 pounds. The steel frame is foldable for easy storage and transport.

The adjustable steering tiller provides optimum mobility and control when on the go. When resting, the parking brake system can lock the wheels in place. The padded knee platform features a contoured cushion for stability and comfort and is easily customized using the height adjustment knob.



WHEELCHAIR CUSHIONS

Foam and Gel Wheelchair Cushions

Foam 16x3x • Each

Size	Item#
16in	WCF16163
18in	WCF18163
20in	WCF20163

Gel 16x3x • Each

Size	Item#
16in	WCG16163
18in	WCG18163
20in	WCG20163

HCPCS# E2601

- Supports up to 250 lbs
- Breathable, washable, waterproof cover
- Fire-retardant materials
- Retail packaging is attractive and stackable with easy size and type identification shown on the side

Foam is lightweight

Gel includes a gel bladder inside the foam for more support



Lumbar Cushion

Item#

WCL18

18in • Each

HCPCS# E2611



High quality memory foam gives Sunset's wheelchair lumbar cushion an added level of comfort. In addition to easing back pain, the lumbar cushion also helps maintain spine alignment. A removable cover makes washing easy and quick.

Visit www.sunsethcs.com



PPE

KN95 Mask

Item#
PPE1001KU
Box of 30 Masks
• 5 layers



Item#
PPE1002KE
Box of 20 Masks
• 4 layers



Disposable 3-Ply Face Mask

Item#
PPE1002PS
Adult • 6^{7/8} x 3^{3/4} in
Box of 50 Masks



Item#
PPE1003PPB
Pediatric • 5^{5/8} x 3^{3/4} in
Box of 10 Masks

- Hypoallergenic
- Comfortable
- Breathable
- Fiberglass-free
- 3 layers of polypropylene (a meltblown layer between two soft non-woven layers)



Disposable Gown

Item#
PPE5003L
100/case

- Meets the standard performance requirement of AAMI PB70 Level 1 for isolation gowns, including the seam of the neckline and cuff.
- 20 bags of 5 gowns per case



Disposable Face Shields with Elastic Strap

Item#
PPE3001FS-F
Adult
Each

- High-density foam forehead rest
- Clear, anti-fog vision



Item#
PPE3002PFS-M
Pediatric
Monster Design
Each

NEW



Item#
PPE3002PFS-A
Pediatric
Animal Design
Each



Disposable Level 2 Surgical Face Mask

Item#
PPE1002SM
Box of 50 Masks

- Medical classification and 510(k)
- 98% bacterial filtration efficiency
- Rated for moderate risk levels of aerosols, spray, and/or fluids



Disposable Tearaway Gown

Item#
PPE5002
25/pack

- Level 3 ASTM F3352
- Individually sealed
- Made in the USA



PPE

Alcohol Wipes

Item#
CAP1003A
56 packs of 50 wipes/case

- 75% Isopropyl Alcohol



Hand Sanitizer

Item#
CAP1022-16
16.9oz Pump Bottle
20/case

- Kills 99.9% of Germs
- 70% Ethyl Alcohol



Mini Pistol Grip Non-Contact Thermometer

Item#
PPE4001-J
Infrared
Each

- Forehead mode for all ages
- Object measurement mode
- HD LCD display
- Battery: AAAx2
- Fever warning: 6 short double beeps
- Memory storage: 20 sets of measureable data
- Fahrenheit and Celsius
- Automatic shutdown: 10 seconds
- Professional accuracy (plus or minus 0.6 degrees F when measuring forehead temperatures from 89.6 through 107.9 degrees F)



Mini Wand Style Non-Contact Thermometer

Item#
PPE4002-A
Infrared
Each

- One second reading
- One click operation
- Fahrenheit and Celsius
- 3/4 to 2-inch measuring distance



CleanSmart Disinfectant

Item#
CAP1019-C
23oz Spray Bottle
6/case

- CleanSmart is EPA listed as a broad-spectrum and hospital disinfectant
- EPA Registration Number 89896-2
- CleanSmart is formulated for disinfecting surfaces of external medical equipment and external surfaces of respiratory equipment
- CleanSmart is included on the EPA's List N: Disinfectants for Use Against SARS-CoV-2, the virus that causes COVID-19
- Active ingredient Hypochlorous Acid does not leave a chemical residue



CleanSmart Alcohol-Free Hand Cleanser

Item#
CAP1021-HC8
8oz Spray Bottle
6/pack

CAP1021-HC2
2oz Spray Bottle
9/pack

- Same active ingredient as CleanSmart cleaner, in a hand cleanser.



Nitrile Gloves

Ask us about our gloves and item numbers, which may vary based on available supply.

NEW



Phone (877) 578-6738

Fax (312) 997-9985

Email sales@sunsethcs.com

Visit www.sunsethcs.com



Our goal is simple:
To help you grow your business and be
your HME partner

We're just easier to work with

- A knowledgeable staff member answers every phone call
- Private labeling
- Flexible packaging options
- No minimum orders
- The ability to acquire almost any product

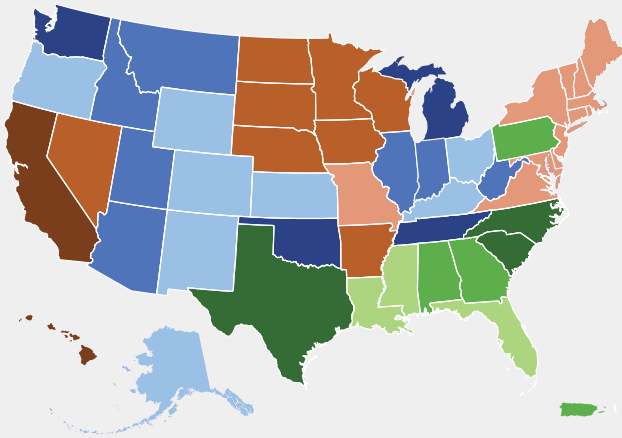

Your sales representatives



Phil Cosens
Direct 312-533-2470
Ext 219
Email pcosens@sunsethcs.com



Danielle Dubowski
Direct 312-533-2479
Ext 231
Email ddubowski@sunsethcs.com



Mark Lipson
Direct 312-533-2465
Ext 228
Email mlipson@sunsethcs.com



Emily Campbell
Direct 312-533-2462
Ext 205
Email ecampbell@sunsethcs.com



Brian Lipson
Direct 312-533-2463
Ext 217
Email blipson@sunsethcs.com



Brad Obler
Direct 312-533-2486
Ext 208
Email bobler@sunsethcs.com



Sean O'Donnell
Direct 312-637-6558
Ext 558
Email sodonnell@sunsethcs.com



Owen Ruth
Direct 312-533-2451
Ext 206
Email oruth@sunsethcs.com



Hailey Brady
Direct 847-380-2820
Ext 870
Email hbrady@sunsethcs.com



Katie Moses
Direct 312-533-2482
Ext 234
Email kmoses@sunsethcs.com



Brady Johnson
Direct 312-533-2464
Ext 210
Email bjohnson@sunsethcs.com



Cindy Geighes
Direct 312-533-2478
Ext 230
Email cgeighes@sunsethcs.com

National Accounts



Nikki Zemovich
Direct 312-533-2469
Ext 218
Email nzemovich@sunsethcs.com



Gabrielle Barruzza
Direct 312-638-8680
Ext 680
Email gbarruzza@sunsethcs.com



Tierney O'Brien
Direct 312-533-2458
Ext 226
Email tobrien@sunsethcs.com



Phone 877-578-6738
Fax 312-997-9985
Email sales@sunsethcs.com
Visit www.sunsethcs.com

Corporate Headquarters
180 N Michigan Ave Ste 2000
Chicago, IL 60601

Central Distribution Center
279 Madsen Dr Ste 101
Bloomington, IL 60108

Western Distribution Center
2450 Statham Blvd
Oxnard, CA 93033