



Product Catalog

POLICIES

Ordering Options

Three Easy Ways To Order

Phone

1-312-533-2455

Our customer service professionals are here to assist you
M-F 8:00 AM – 5:00 PM Central Time.

Fax

1-312-724-7650 — Accepted 24 hours a day.

Email

bvigna@sunsethcs.com

Payment Methods

Payment Portal and ACH

Visit www.sunsethcs.com/paymentportal to pay online with ACH or credit card.

Net 30-Day Payment Terms

For qualified companies. A 1.5% monthly finance charge will be assessed on all past due invoices.

COD

For non-qualified companies.

Credit Card

We accept all major credit cards. A processing fee may apply. After 10 days of invoice date, a surcharge of 2.5% will be applied.



Shipping

Drop shipping available — ask your sales rep about sending your order to multiple locations.

UPS

Whenever possible, orders ship via UPS. If another carrier is desired, please contact your sales rep.

All orders are packed in the smallest boxes available and combined with other products on the order to reduce shipping costs.

All products ship prepaid and are added to the invoice.

All products ship from Bloomingdale, IL or Oxnard, CA. Please refer to UPS.com for transit times.

Damaged Merchandise

Call us within 10 days. Keep original cartons for UPS inspection.

We proudly partner with



Customer Service

Returns

Call us for a return authorization number. There is no restocking charge on orders returned within 20 days of invoice. Orders returned after 20 days may be assessed a restocking fee of 15%. No returns after 90 days. (877) 5-SUNSET (877-578-6738)

Central Distribution Center

Sunset Healthcare Solutions
279 Madsen Dr Ste 101
Bloomingdale, IL 60108
USA

Western Distribution Center

Sunset Healthcare Solutions
2450 Statham Blvd
Oxnard, CA 93033
USA

Problems

Please call us immediately if you have any complaints (it is helpful to ask for the customer service representative with whom you placed your order).

Or email us at: customerservice@sunsethcs.com

Questions?

Our experienced customer service staff will be glad to provide you with information. Just give us a call.

Pricing

All prices are in U.S. Dollars.

Taxes are added where applicable.

We make every effort to hold pricing throughout the year. However, prices are subject to change without notice.

Contact us for more information on fulfillment and compliance solutions that best fit your needs.

CONTENT

CPAP

	Page
Cleaners	4-5
Masks and Replacement Parts	6-15
Sunset Healthcare Solutions	6-7
Sleepnet	8-9
Circadiance	10-11
AirAvant	11
InnoMed	12-13
Airway Management	13
Filters	14-22
Respironics	14-15
ResMed	16-17
Fisher & Paykel	18
3B	19
AEIOMed	19
Breas/GE	19
CareFusion/Viasys	20
Covidien Nellcor Puritan Bennett	20
DeVilbiss	21
Evo Medical	21
Healthdyne	22
Invacare	22
ProBasics	22
Tubing	23
Chinstraps	24-25
Headgear	25
Cash Items	26-31
Somnifix	26
Mask Liners	26
Batteries	27
Self Care and Organization	28-29
Connectors, Adapters, and Inline Filter	29
Tubing Wraps	30

Oxygen

	Page
Firesafe	32
Masks	33
Pulse Oximeters	33
Cannula	34-35
Cylinder Carriers	36-37
Accessories	38-39
Conservar	38
Cleaners	39
Concentrator Cabinet Filters	40-43
Caire/AirSep/Sequal	40
CHAD	40
Covidien Nellcor Puritan Bennett	41
DeVilbiss/Drive	41
Inogen	42
Invacare	42
Nidek	42
Respironics/Healthdyne	43
3B	43

Other

	Page
Nebulizers	45
Aerosol	45
Nebulizer Filters	46
PPE	46
Mobility	47

ZOEY CPAP CLEANER

Zoey CPAP Cleaner

Item# **ZCD100**

Each



Comes with

- Main unit
- Tube connector (for cleaning machine, mask, and tube)
- Ozone plug adapter (for cleaning mask and tube only)
- Injection tube with check valve
- Filter
- Power adapter
- User manual



Sunset presents Zoey CPAP Cleaner, a new and stylish way for patients to clean CPAP equipment.

Zoey is a DME-exclusive item, and only available for patient purchase through providers. Sunset never sells directly to the end consumer.

Choose what to clean

Patients can clean their mask, tube, and machine, or just their mask and tube. Zoey gives them options.

Easy to use, quiet and sleek

Clean or set delay mode with a single button. With a small footprint and quiet operation, Zoey fits in the home.

O3 technology

Zoey cleans using contained activated oxygen.



Zoey Adapters and Accessories

ZCD100KIT	Filter and Check Valve Kit
CAP1016S	Zoey Quick Release Connector
ZCD100A-DS	Heated Tube Adapter for DreamStation/PR System One
ZCD100A-A10	Heated Tube Adapter Lid for ResMed AirSense 10
ZCD100A-S9	Heated Tube Adapter Lid for ResMed S9
ZCD100TC	Replacement Tube Connector (used when cleaning machine)
ZCD100A-P	Replacement Ozone Plug Adapter (used when not cleaning machine)
ZCD100IT	Replacement Injection Tube with Check Valve
ZCD100F	Replacement Filter
ZCD100PA	Replacement Power Adapter
POSZCD	Poster
CARDZCD	Rack Cards
ZCD100-DEMO	Nonfunctional Demo Unit



Visit cleanwithzoey.com
for more information
and marketing support



CLEANERS AND ACCESSORIES

Sunset Cleaning Wipes — Flowpack

Item#
CAP1003S

12/case
Flowpack of 64 wipes

- Ingredients are safe and gentle for daily cleaning of all types of CPAP and oxygen masks



Private Label CPAP Wipes

Order the flowpack wipes with your logo and contact info on a lid sticker, with a minimum quantity commitment. Talk to your sales rep for more info.



CPAP Tube Cleaning Brush

Size	Item#
Standard 6ft	CAP1013
Slim 6ft	CAP1013SS

- Brushes all the way through a 6ft CPAP tube without leaving debris in the middle
- Stainless steel wire and soft nylon bristles



Cleaning Wipes — Single Packs

Item#
CAP1005S

Sunset Box of 30 single-pack wipes
Each

CAP1005

Citrus II Box of 12 single-pack wipes
12/case

- Convenient individually wrapped wipes are great for patient samples or travel use

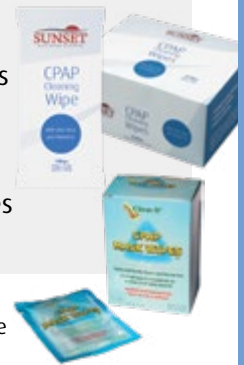

Citrus II Cleaning Wipes

Item# **CAP1003**
Canister of 62 wipes
12/case



Citrus II Mask Cleaning Spray

Item# **CAP1001**
1.5oz • **24/case**

- All-natural cleanser for daily mask cleaning
- Available in 1.5oz travel size or 8oz non-aerosol spray cans

Item# **CAP1002**
8oz • **12/case**



Citrus II Concentrate

Item# **CAP1004**
32oz • **Each**

- Formulated for weekly cleaning of tubing and accessories
- Mix 4oz of concentrate with 1 gallon of water



Filter Replacement Kit for SoClean 2

Item# **CAP1007S-KIT**
Each

- With filter, check valve, retail packaging and instruction manual
- Replace every 6 months



SUNSET HEALTHCARE SOLUTIONS

Sunset Deluxe Full Face CPAP Masks

Mask with Flex Tube, Headgear, and Replaceable Cushion

Size	Item#
Small	CM005S
Medium	CM005M
Large	CM005L

Unobtrusive design offers a clear line of sight

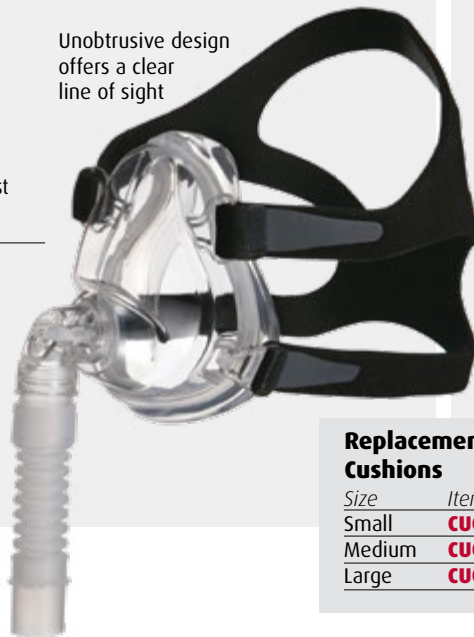

HG003 Headgear - Fits Most
HG003XL Headgear - XL

CMSIZE01
Deluxe Sizing Guide

HCPCS#
MASK - A7030
HEADGEAR - A7035
CUSHION - A7031

Mask without Headgear

Size	Item#
Small	CM005SNH
Medium	CM005MNH
Large	CM005LNH

Replacement Cushions

Size	Item#
Small	CUCM005S
Medium	CUCM005M
Large	CUCM005L

- 360° dual-swivel elbow port allows for free movement while connected to the tubing
- Quick-release clips make it easy to remove the mask without resetting the headgear
- Ultra-lightweight silicone replaceable cushion increases comfort while maintaining optimal seal

Mask with Adjustable Forehead T, Headgear, and Replaceable Cushion

Size	Item#
Small	CM105S
Medium	CM105M
Large	CM105L

NEW



Sunset Deluxe Nasal CPAP Masks

Mask with Headgear and Replaceable Cushion

Size	Item#
Small	CM006S
Medium	CM006M
Large	CM006L

Same features as the full face with 360° dual-swivel elbow port, quick release clips, and ultra-lightweight replaceable cushions.



HG003 Headgear - Fits Most
HG003XL Headgear - XL

CMSIZE01
Deluxe Sizing Guide

HCPCS#
MASK - A7034
HEADGEAR - A7035
CUSHION - A7032

Mask without Headgear

Size	Item#
Small	CM006SNH
Medium	CM006MNH
Large	CM006LNH

Replacement Cushions

Size	Item#
Small	CUCM006S
Medium	CUCM006M
Large	CUCM006L

Mask with Headgear, Adjustable Forehead T, and Replaceable Cushion

Size	Item#
Small	CM106S
Medium	CM106M
Large	CM106L

NEW



SUNSET HEALTHCARE SOLUTIONS

Sunset Deluxe Nasal Pillow CPAP Mask

Item#

CM036

Mask with Headgear and Small, Medium, and Large Pillows

HG036

Headgear Only

HCPCS#

MASK - A7034

HEADGEAR - A7035

PILLOWS - A7033



Replacement Pillows

Size Item#

Small **CM036SP**

Medium **CM036MP**

Large **CM036LP**



Mask without Headgear

CM036NH

- Easy to fit, assemble, and maintain
- Three different pillow sizes to fit more people more easily
- 360° rotational elbow with flexible silicone tube
- Quiet vent design

Sunset Clearsight Deluxe Nasal Mask

Mask with Headgear and Replaceable Cushion

Size Item#

Small **CM110S**

Medium **CM110M**

Large **CM110L**



HG003 Headgear - Fits Most

HG003XL Headgear - XL

Replacement Cushions

Size Item#

Small **CUCM110S**

Medium **CUCM110M**

Large **CUCM110L**

HCPCS#

MASK - A7034

HEADGEAR - A7035



- Clearsight design provides unobstructed view

Mask Series	Mask Type	Replaceable Cushion	Forehead Support	Flex Tube Included	Headgear Included
CM005	Full Face	✓		✓	✓
CM105	Full Face	✓	✓ (Adjustable)		✓
CM006	Nasal	✓	✓	✓	✓
CM106	Nasal	✓	✓ (Adjustable)		✓
CM007	Full Face				✓
CM008	Nasal				✓
CM110	Nasal	✓			✓
CM036	Nasal Pillow	✓		✓	✓

Sunset Classic Full Face CPAP Mask



Mask with Headgear

Size Item#

Small **CM007S**

Medium **CM007M**

Large **CM007L**

Extra Large **CM007XL**

HG003 Headgear - Fits Most

HG003XL Headgear - XL

CMSIZE02

Classic Sizing Guide

HCPCS#

MASK - A7030

HEADGEAR - A7035

1/2 THE WEIGHT OF LEADING MASKS

- Conventional forehead pad removed
- to create a clear line of sight
- Minimalist design and ultra-lightweight silicone
- Quick-release clips make it easy to remove
- 360° dual-swivel elbow port allows for free movement
- One-piece mask and cushion design is durable and easy

Sunset Classic Nasal CPAP Mask



Mask with Headgear

Size Item#

Medium **CM008M**

Large **CM008L**

HG003 Headgear - Fits Most

HG003XL Headgear - XL

CMSIZE02

Classic Sizing Guide

HCPCS#

MASK - A7034

HEADGEAR - A7035

- Great value for cash patients or those with lower insurance reimbursement
- Headgear clips allow for quick removal of mask — no further adjustments required after initial fitting
- One-piece mask and cushion design is durable and easy

Visit www.sunsethcs.com



SLEEPNET

Innova

Nasal Mask with Headgear

Size	Item#
Small/Medium	CM034SM
Medium/Large	CM034ML

HCPCS#
MASK - A7034
HEADGEAR - A7035

Full Face Mask with Headgear

Size	Item#
Small	CM035S
Medium	CM035M
Large	CM035L

HCPCS#
MASK - A7030
HEADGEAR - A7035



Innova® CPAP masks feature patented AIR^ogel with Advanced Cushion Technology and Active Headgear Connector™. Together, they provide an optimal fit, maximum comfort, and freedom.

- The Touchless Spacebar's unique design eliminates any contact with the patient's forehead
- The quick-release headgear is lightweight, breathable, and slides off easily with one hand
- Made in the USA

MiniMe Pediatric Nasal Mask

Mask with Headgear

Headgear Size	Item#	OEM#
Small	CM004S	60213
Medium	CM004M	60214
Large	CM004L	60215



Replacement Headgear

Size	Item#	OEM#
Small	HG010S	55241
Medium	HG010M	55242
Large	HG010L	55243

HCPCS#
MASK - A7034
HEADGEAR - A7035

- Non-vented version available

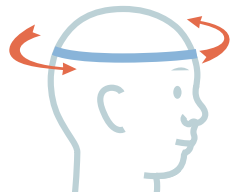

MASK SIZE	HEAD CIRCUMFERENCE
SMALL	14-16in
MEDIUM	17-18in
LARGE	19-21in

Measure around head above eyebrows for head circumference

MiniMe 2 Pediatric Nasal Mask

Mask with Headgear

Size	Item#	OEM#
Extra Small	CM027XS	60216
Small	CM027S	60217
Medium	CM027M	60218
Large	CM027L	60221



Replacement Headgear

Size	Item#
Extra Small/Small	HG027S
Medium/Large	HG027L

HCPCS#
MASK - A7034
HEADGEAR - A7035

- Non-vented version available



Ascend

Nasal Mask with Headgear and All Cushions

Item# **CM037N**

Replacement Cushions

Size	Item#
Small	CM037NCS
Medium	CM037NCM
Large	CM037NCL

Nasal Mask with Headgear and 1 Cushion

Size	Item#
Small	CM037NS
Medium	CM037NM
Large	CM037NL

HCPCS#
 MASK - A7034
 HEADGEAR - A7035
 CUSHION - A7032

Full Face Mask with Headgear and All Cushions

Item# **CM037F**

Replacement Cushions

Size	Item#
Small	CM037CS
Medium	CM037CM
Large	CM037CL

Full Face Mask with Headgear and 1 Cushion

Size	Item#
Small	CM037S
Medium	CM037M
Large	CM037L

HCPCS#
 MASK - A7030
 HEADGEAR - A7035
 CUSHION - A7031

- One frame with three sizes of replaceable cushions: S, M, L
- Unique flexible spacebar design provides superior stability, holding a seal without contacting the skin
- Sleepnet's patented AIR^ogel minimizes pressure points and skin irritation while offering maximum comfort with minimum weight
- Lightweight, breathable quick-release headgear slides off easily with one hand
- 360-degree rotating elbow for optimal tube positioning and easier mobility
- Active Headgear Connector moves as the patient moves for a reliable seal
- Made in the USA

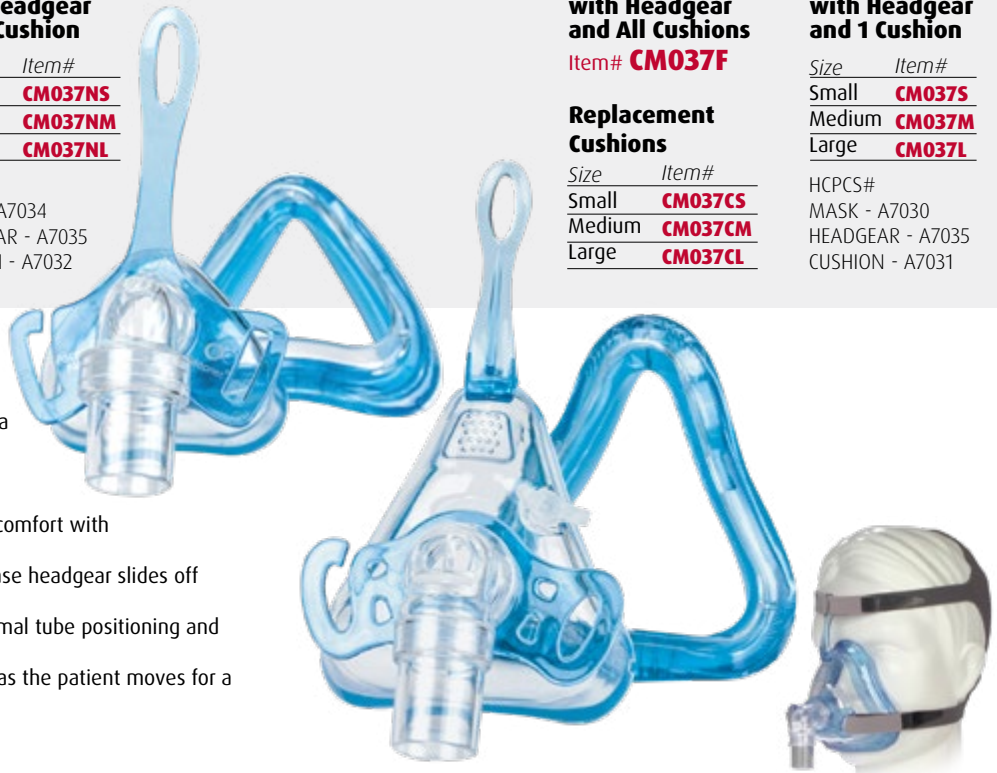

iQ Nasal Mask

Item# **CM001**

iQ Nasal Mask with Headgear
 OEM# TMS-889

HCPCS#
 MASK - A7034
 HEADGEAR - A7035

HG005

3-Point Headgear Only
 OEM# TMS-89-55046

HG009

Holey Cap Style Headgear Only



Mojo 2 Full Face Mask

Mask with Headgear

Size	Item#	OEM#
Small	CM50817	50817
Medium	CM50818	50818
Large	CM50819	50819
Extra Large	CM50820	50820

- Maximum comfort, minimum weight. Patented AIR^ogel minimizes pressure points and skin irritation.
- Forehead adjustment screw removes pressure from the bridge of the nose for personalized fit.
- The shapeable shell of each mask can be easily molded to fit individual needs. Bend it. Mold it. Shape it.
- Lightweight, breathable headgear disconnects from mask easily with one hand thanks to the quick-release magnetic headgear clips.
- Oxygen port allows easy delivery of supplemental oxygen.
- 360° rotating elbow for optimal tube positioning and easier mobility.



Mojo Full Face Mask

Mask with Headgear

Size	Item#	OEM#
Small	CM003SH	TMS-835
Medium	CM003MH	TMS-836
Large	CM003LH	TMS-837

Replacement Headgear

HG003
 OEM# TMS-89

HCPCS#
 MASK - A7030
 HEADGEAR - A7035



Visit www.sunsethcs.com

CIRCADIANCE

SleepWeaver® Advance Nasal Mask



Blue

- One size fits most (Small Tan available for smaller faces)
- Includes Advance headgear that can be adjusted to fit a broader range of patients



Leopard



Camo



Pink



Tan

Mask with Adjustable Headgear

Mask Color	Item#	OEM#
Blue	CM017B	100274
Camo	CM017C	100281
Leopard	CM017L	100285
Pink	CM017P	100277
Tan	CM017T	100332

CM017T-S

Small Tan
OEM# 101224

HCPCS#
MASK - A7034
HEADGEAR - A7035

HG017

Headgear Only
OEM# 100435

CM017TNH

Tan — No Headgear
OEM# 100336

- Easy to store and pack for travel

SleepWeaver® Élan Nasal Mask

Mask Kit

Mask Color	Item#	OEM#
Tan	CM022T-KIT	100563
Blue	CM022B-KIT	100782

Kits Include:

- Mask
- Small Cushion
- Regular Cushion
- Large Cushion
- Headgear
- Feather Weight Tube®
- Overhead Tube Tether Strap
- Quick Start Illustration Guide
- Instructional DVD

HCPCS#

MASK - A7034
HEADGEAR - A7035
TUBE - A7037

TUB0018F

Replacement
Feather Weight Tube®
OEM# 100477

HG022

Headgear Only
OEM# 100630

Mask with Headgear only

Size and Color	Item#	OEM#
Small Blue	CM022B-S	100728
Regular Blue	CM022B-R	100519
Large Blue	CM022B-L	100482
Small Tan	CM022T-S	100727
Regular Tan	CM022T-R	100518
Large Tan	CM022T-L	100481

All SleepWeaver Masks

- Made of soft cloth
- Allow sleeping on side, stomach, and even wearing glasses
- Easy to store and pack for travel
- Hand or machine washable gentle cycle, mild detergent, hang to dry

Replacement Cushions

Size and Color	Item#	OEM#
Small Blue	CUCM022B-S	100743
Regular Blue	CUCM022B-R	100654
Large Blue	CUCM022B-L	100664
Small Tan	CUCM022T-S	100742
Regular Tan	CUCM022T-R	100653
Large Tan	CUCM022T-L	100663
Small Leopard	CUCM022L-S	100746
Reg. Leopard	CUCM022L-R	100657
Large Leopard	CUCM022L-L	100667



- Detachable 90° elbow with 360° rotation allows for over-the-head hose placement

CIRCADIANCE

SleepWeaver® Anew™ Full Face Mask

Blue Mask with Headgear

Size	Item#	OEM#
Small	CM026B-S	100955
Regular	CM026B-R	100960
Large	CM026B-L	100965



Headgear

Size	Item#	OEM#
Small	HGCM026-S	101145
Reg/Lg	HGCM026-R	101084

TUB0018F

Featherweight Tube
OEM# 100477

HCPCS#
MASK - A7027
HEADGEAR - A7035
TUBE - A7037

- Soft material wicks away moisture and leaves no pressure marks on the face
- Loose fit provides ultimate comfort and eliminates strap marks
- Open line of sight accommodates eyeglasses and is great for people who like to fall asleep while reading or watching TV
- 90° elbow swivel connector rotates 360° allowing users to sleep in more natural positions; easy to remove and clean

Pediatric SleepWeaver® CPAP Mask

Item#
CM101325

- Same proven cloth technology enhanced to accommodate children 2 through 7 years of age

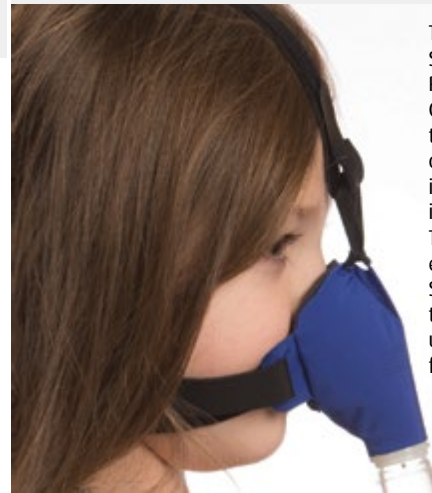

The launch of the SleepWeaver Advance Pediatric Soft Cloth CPAP Mask marks the development of a revolutionary interface for CPAP use in pediatric patients. This new configuration extends the range of SleepWeaver products to include pediatric users with delicate facial features.

AIRAVANT

Bongo Rx EPAP

Item#
CAPBNG500

Bongo Rx all sizes starter kit

- All four sizes: small, medium, large, and extra large
- Travel case
- Drying stand
- Headgear



Annual Replenishment Pack

Includes 4 pairs, travel case, drying stand, and headgear

Size	Item#
Small	CAPBNG502
Medium	CAPBNG503
Large	CAPBNG504
Extra Large	CAPBNG505



The Bongo Rx is a simple device with soft nasal seals and is available in various sizes (S, M, L, and XL). The Bongo Rx is an EPAP (expiratory positive airway pressure) device and works as follows:

- During inhalation, small valves open to allow normal breathing through the device.
- During exhalation, the valves close and direct exhaled air through small vents to generate EPAP, which keeps the airway open.

Single Replenishment Pack

Includes 1 pair and headgear

Size	Item#
Small	CAPBNG512
Medium	CAPBNG513
Large	CAPBNG514
Extra Large	CAPBNG515



- No machine, tube, electricity, or batteries needed
- Use at home, traveling, camping... use anytime, anywhere
- Small enough to fit in a shirt pocket
- Reusable and easy to clean with simply soap and water
- Designed, molded, and assembled in the USA
- Clinically tested to demonstrate safety and effectiveness
- Supplemental lifestyle option for your compliant patients
- Patient friendly option for your non-compliant patients

Aloha® Nasal Pillows System

Item#

CM014

All Sizes Kit

OEM# ALO100

Replacement Headgear

HG014

Aloha Headgear

OEM# ALO130

Replacement Pillows

Size	Item#	OEM#
Small	CM014SP	ALO121
Medium	CM014MP	ALO123
Large	CM014LP	ALO125



Frame

Size	Item#	OEM#
Small	CM014FS	ALO131
Medium	CM014FM	ALO133
Large	CM014FL	ALO135

HCPCS#

MASK - A7034

HEADGEAR - A7035

PILLOWS - A7033

- One of the highest consumer-rated CPAP masks on the market
- Limited headgear reduces points of contact on the face and prevents interference with the eyes
- Removable micro-fleece headgear wraps are included for comfort
- Pillow angle can be adjusted for a more customized and natural fit

NasalAire II® Mask

Item#

CM016

All Sizes Kit

OEM# K2A

Mask with Frame, Pillows, and Headgear

Size	Item#	OEM#
Extra Small	CM016XS	XS301
Small	CM016S	SM302
Medium	CM016M	MD303
Medium Plus	CM016MP	MP304
Large	CM016L	LG305
Extra Large	CM016XL	XL306

Petite Mask with Frame, Pillows, and Headgear

Size	Item#	OEM#
A (Largest)	CM016PA	PA401
B	CM016PB	PB402
C	CM016PC	PC403
D	CM016PD	PD404
E (Smallest)	CM016PE	PE405

HCPCS#

MASK - A7034

HEADGEAR - A7035

PILLOWS - A7033

Replacement Headgear

Regular **HG016** OEM# X2105

Petite **HG016P** OEM# P430



Replacement Nasal Piece/Cannula

Size	Item#	OEM#
Extra Small	CM016XSCAN	XS01
Small	CM016SCAN	SM02
Medium	CM016MCAN	MD03
Medium Plus	CM016MPCAN	MP04
Extra Large	CM016XLCAN	XL06

Replacement Frame

Size	Item#	OEM#
Extra Small	CM016FXS	NAT321
Small	CM016FS	NAT322
Medium	CM016FM	NAT323
Medium Plus	CM016FMP	NAT324
Large	CM016FL	NAT325
Extra Large	CM016FXL	NAT326

Replacement Petite Nasal Piece/Cannula

Size	Item#	OEM#
A (Largest)	CM016PACAN	PA411
B	CM016PBCAN	PB412
C	CM016PCCAN	PC413
D	CM016PDCAN	PD414
E (Smallest)	CM016PECAN	PE415

Hybrid® Mask

Item# **CM015**
All Sizes Kit
OEM# HYB500

Replacement Headgear

HG015
Hybrid Headgear
OEM# HYB530



Replacement Pillows

Size	Item#	OEM#
Small	CM015SP	HYB521
Medium	CM015MP	HYB523
Large	CM015LP	HYB525

Replacement Cushions

Size	Item#	OEM#
Small	CUCM015S	HYB511
Medium	CUCM015M	HYB513
Large	CUCM015L	HYB515



HCPCS#
MASK - A7027
HEADGEAR - A7035
PILLOWS - A7033
CUSHION - A7031

Aspen® Mask

Mask with Headgear and Cushion

Size	Item#	OEM#
Small	CM029S	ASP201
Medium	CM029M	ASP203
Large	CM029L	ASP205

HCPCS#
MASK - A7030
HEADGEAR - A7035
CUSHION - A7031

Replacement Headgear

HG029 Aspen Headgear
OEM# ASP230



Replacement Cushions

Size	Item#	OEM#
Small	CUCM029S	ASP211
Medium	CUCM029M	ASP213
Large	CUCM029L	ASP215

The Aspen is compact, quiet, lightweight, and affordable.

- Built-in chin flap gently supports the chin
- Resilient yet stable forehead pad is highlighted by a SoftTouch Wrap
- Headgear features a crown strap for extra comfort and support
- Headgear has five adjustment points
- Extremely quiet exhalation port design
- All 3 cushion sizes fit the single mask shell

AIRWAY MANAGEMENT

Tap Pap

No headgear needed!

Item#
CM024NH

Mask Kit with Small, Medium, and Large Pillows
OEM# PAP-NP1-000

Replacement Pillows

Size	Item#	OEM#
Small	CUCM024S	PAP-NP1-101
Medium	CUCM024M	PAP-NP1-102
Large	CUCM024L	PAP-NP1-103

CM024NH
Mask Kit without
Headgear
OEM# PAP-NP1-001

CM024MP
Replacement Mouthpiece
OEM# PAP-NP1-201

HG024
Tap Pap Headgear
OEM# PAP-NP1-300

HCPCS#
MASK - A7034
PILLOWS - A7033
HEADGEAR - A7035



- Mouthpiece molds to the upper teeth to provide a custom and secure fit even if the bottom teeth are not in contact with the mouthpiece
- Unique nut and bolt joint allows the nasal pillows to be set to the desired angle
- Provides a stable fit regardless of the sleep position
- Patients report not being able to feel the mask on their face
- 3 sizes of nasal pillows included (Small, Medium, and Large)
- 90-day compliance guarantee for new users of the mask, 30-day guarantee for experienced users

DreamStation



Item# CF1010
Disposable Filter
6/pack
OEM# 1122519
HCPCS# A7038
CF1010-1 1/pack
CF1010-2 2/pack

Item# CF1010F
Reusable Filter
2/pack
OEM# 112446 (1-pack)
HCPCS# A7039
CF1010F-1 1/pack
CF1010F-6 6/pack



DreamStation Go Filters



NEW

Item# CF101130D
30-Day Disposable Filter
6/pack
OEM# 1133744
HCPCS# A7038

Item# CF101190D
90-Day Reusable Filter
2/pack
OEM# 1133743
HCPCS# A7039

PR System One



Item# CF1009NT
Ultrafine Filter - No Tab
6/pack • 1³/₄" x 7⁸/₈"
OEM# 1029331
HCPCS# A7038
CF1009NT-1 1/pack
CF1009NT-2 2/pack

Item# CF1009
Ultrafine Filter - Tabbed
6/pack • 1³/₄" x 7⁸/₈"
HCPCS# A7038
CF1009-1 1/pack
CF1009-2 2/pack

Item# CF1009F
Foam Filter
2/pack • 1⁵/₈" x 7⁸/₈"
OEM# 1029330
HCPCS# A7039
CF1009F-1 1/pack

M-Series



Item# CF1007
Ultrafine Filter - Tabbed
6/pack • 1³/₄" x 7⁸/₈"
HCPCS# A7038
CF1007-1 1/pack
CF1007-2 2/pack

Item# CF1007F
Foam Filter
2/pack • 1⁵/₈" x 7⁸/₈"
HCPCS# A7039
CF1007F-1 1/pack

Item# TUB06CF1009NTF
PR System One No Tab Filter
and CPAP Tube Kit
1 - CF1009NT
1 - CF1009F
1 - 6ft CPAP Tube



*Private labeling and kitting
available at no extra charge*

RESPIRONICS

BiPAP Pro, Plus, Duet LX, Synchrony



Item# **CF1005**
Ultrafine Filter
6/pack • 4^{3/4}" x 3^{1/4}"
OEM# 622219
HCPCS# A7038

Item# **CF1005F**
Foam Filter
2/pack • 4^{3/4}" x 2^{3/8}"
OEM# 622220
HCPCS# A7039

REMstar Pro, REMstar Plus



Item# **CF1006**
Ultrafine Filter
2/pack • 3^{1/2}" x 1^{1/2}"
OEM# 1005945
HCPCS# A7038

Item# **CF1006F**
Foam Filter
2/pack • 3^{5/8}" x 1^{5/8}"
OEM# 1005964
HCPCS# A7039

REMstar



Item# **CF1003**
Ultrafine Filter
6/pack • 5^{1/2}" x 4^{3/4}"
OEM# 362522
HCPCS# A7038

Item# **CF1003F**
Foam Filter
1/pack • 5^{3/4}" x 5^{1/4}"
OEM# 362521
HCPCS# A7039

Aria, Virtuoso, Duet, Quartet



Item# **CF1004**
Ultrafine Filter
6/pack • 3^{1/2}" x 2^{3/16}"
OEM# 532311
HCPCS# A7038

Item# **CF1004F**
Foam Filter
2/pack • 3^{1/4}" x 2^{1/8}"
OEM# 532247
HCPCS# A7039

SleepEasy/BiPAP



Item# **CF1001**
Ultrafine Filter
6/pack • 7^{3/4}" x 4^{7/8}"
OEM# 302064
HCPCS# A7038

Solo, Aria LX, Virtuoso LX, REMstar LX



Item# **CF1002**
Ultrafine Filter
6/pack • 3^{3/8}" x 2^{3/4}"
OEM# 622017
HCPCS# A7038

Item# **CF1002F**
Foam Filter
2/pack • 3^{5/16}" x 2^{5/16}"
OEM# 622018
HCPCS# A7039

Filter Replacement for Respironics Machines

- Step 1** Insert the white ultrafine filter with the webbed plastic or shiny side facing in toward the machine. This filter protects the patient from bacteria and allergens in the air.
- Step 2** Place black foam filter in second to protect the machine from large particles and pollen.



*All filters can be ordered in any pack quantity.
Contact your sales rep for details.*

AirMini



Item# **CF2108**
 Disposable Filter
2/pack • 1¹/₄" x 1³/₁₆"
 OEM# 38815
 HCPCS# A7038

S9 and AirSense 10 Series



Item# **CF2107**
 Disposable Filter
3/pack • 2¹/₈" x 1³/₈"
 HCPCS# A7038

CF2107-1 1/pack OEM# 36850
CF2107-2 2/pack OEM# 36851
CF2107-50 50/pack OEM# 36853



Item# **TUB06S9COMBO**
 S9 Filter and CPAP Tube Kit
 6 - CF2107
 1 - 6ft CPAP Tube

KIT



Item# **CF2107HA**
 Hypoallergenic Filter
3/pack • 2¹/₈" x 1³/₈"
 HCPCS# A7038

CF2107HA-1 1/pack OEM# 36855
CF2107HA-2 2/pack OEM# 36856
CF2107HA-50 50/pack
 OEM# 36858

Adapt SV



Item# **CF2106**
 Disposable Filter
3/pack • 1¹/₄" x 1¹/₂"
 OEM# 26926
 HCPCS# A7038

CF2106-50 50/pack

Item# **CF2106HA**
 Hypoallergenic Filter
3/pack • 1¹/₄" x 1¹/₂"
 OEM# 26927
 HCPCS# A7038

CF2106HA-50 50/pack

Auto Set T



Item# **CF2104**
 Disposable Filter
3/pack • 4¹/₄" x 3¹/₄"
 OEM# 17937
 HCPCS# A7038

CF2104-50 50/pack OEM# 17938

Filter Replacement for ResMed Machines

- Step 1** Open air filter hatch on back of machine.
- Step 2** Remove old filter and discard. Filters are not washable/reusable.
- Step 3** Insert filter with blue side facing out. If using S9 or AirSense 10 filters, insert any side.
- Step 4** Close air filter hatch.

S8 Series

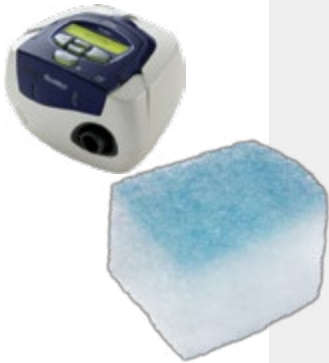

Item#
CF2105
Disposable Filter
3/pack • 1³/₈" x 1³/₈"
OEM# 33916
HCPCS# A7038

CF2105-1 1/pack OEM# 33915
CF2105-2 2/pack OEM# 33973
CF2105-50 50/pack OEM# 33918



KIT

Item#
TUB06S8COMBO
S8 Filter and CPAP Tube Kit
6 - CF2105
1 - 6ft CPAP Tube



Item#
CF2105HA
Hypoallergenic Filter
3/pack • 1³/₈" x 1³/₈"
OEM# 33920
HCPCS# A7038

CF2105HA-1 1/pack OEM# 33919
CF2105HA-2 2/pack OEM# 33975
CF2105HA-50 50/pack OEM# 33922

S7 Series



Item#
CF2103
Disposable Filter
3/pack • 1¹/₄" x 1¹/₂"
OEM# 30907
HCPCS# A7038

CF2103-1 1/pack OEM# 30919
CF2103-2 2/pack
CF2103-50 50/pack OEM# 30908

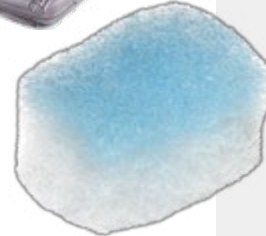

Item#
CF2103HA
Hypoallergenic Filter
3/pack • 1¹/₄" x 1¹/₂"
HCPCS# A7038

CF2103HA-1 1/pack OEM# 30933
CF2103HA-50 50/pack

*All filters can be ordered
in any pack quantity.
Contact your sales rep
for details.*

S6 Series



Item#
CF2102
Disposable Filter
3/pack • 5³/₄" x 5⁵/₈"
OEM# 21935
HCPCS# A7038

CF2102-50 50/pack
OEM# 21936

Sullivan VPAP



Item#
CF2101
Foam and Poly Filter Set
3 sets/pack • 6¹/₂" x 3³/₄"
OEM# 14907
HCPCS# A7038, A7039

CF2101-50 50 sets/pack
OEM# 14908

FISHER & PAYKEL

SleepStyle Series



Item#
CF4004
Disposable Filter
4/pack
HCPCS# A7038



NEW

ICON Series



Item#
CF4003
Disposable Filter
4/pack
2 1/16" x 5/8"
HCPCS# A7038



CF4003-1 1/pack
OEM# 900ICON503

CF4003-6 6/pack
OEM# 900ICON212

HC230 Series, HC600 Series



Item#
CF4002
Disposable Filter
4/pack • 2 3/4" x 7/8"
OEM# 900HC240
HCPCS# A7038
CF4002-2 2/pack



HC200, HC220, HC221



Item#
CF4001
Disposable Filter
4/pack • 5" x 3/4"
OEM# 900HC222
HCPCS# A7038
CF4001-2 2/pack



Enhance your branding!

FREE PRIVATE LABELING



Sunset's free service allows you to put your logo and contact information on our products.

Increase brand awareness and allow patients to easily contact you.

Work with our marketing team to customize the layout with your logo, phone number, website address, and reorder information.

Available on all CPAP tubes and filters. Minimum orders apply. Contact your sales rep for details.

FREE CUSTOM PACKAGING

- Create your own resupply kits with everything you need to fill your orders
- Completely customizable to fit your needs
- Sunset can pack anything from a single ultrafine filter to a 3 or 6 month supply of tubes and filters in one easy-to-handle kit

Custom packaging available on all CPAP tubes, filters, connectors and chin straps. Minimum orders apply.



As featured in *HME News*

3B

Luna and Luna II



Item# **CF8005**
Disposable Filter
12/pack • 2" x 1³/₁₆"
HCPCS# A7038

RESmart



Item# **CF8004**
Disposable Filter
3/pack • 3⁵/₁₆" x 1⁵/₈"
HCPCS# A7038

AEIOMED

Everest Aura, Everest III and Integrated



Item# **CF8001**
Foam Filter
2/pack • 2" x 1⁹/₁₆"
OEM# 100446
HCPCS# A7039

BREAS/GE

iSleep 20 Series



Item# **CF7003**
Ultrafine Filter
2/pack • 2¹/₄" x 7⁷/₈"
OEM# 004153
HCPCS# A7038

Item# **CF7003F**
Foam Filter
Each • 2³/₄" x 1"
OEM# 004154
HCPCS# A7039

PV10



Item# **CF7002**
Ultrafine Filter
2/pack • 2³/₄" x 7⁷/₈"
OEM# 2B01975
HCPCS# A7038

Item# **CF7002F**
Foam Filter
Each • 2⁵/₈" x 7⁷/₈"
OEM# 2B01972
HCPCS# A7039

PV1



Item# **CF7001**
Ultrafine Filter
2/pack • 2¹/₂" x 1¹/₄"
HCPCS# A7038

Item# **CF7001F**
Foam Filter
3/pack • 2¹/₂" x 1¹/₄"
HCPCS# A7039

CAREFUSION/VIASYS

PureSom



Item#
CF9003
Ultrafine Filter
3/pack • 1³/₁₆" x 1⁷/₁₆"
OEM# 7511
HCPCS# A7038

Item#
CF9003F
Foam Filter
3/pack • 1³/₁₆" x 1⁷/₁₆"
OEM# 7510
HCPCS# A7039

Orion and Pegasus



Item#
CF8002
Ultrafine Filter
6/pack • 2⁷/₈" x 1³/₄"
OEM# 774688
HCPCS# A7038

Item#
CF8002F
Foam Filter
Each • 2⁷/₈" x 1³/₄"
OEM# 774689
HCPCS# A7039

COVIDIEN NELLCOR PURITAN BENNETT

GoodKnight 314/318



Item#
CF6005
Ultrafine Filter
2/pack • 6¹/₈" x 9⁹/₁₆"
OEM# S-126924-00
HCPCS# A7038

Item#
CF6005F
Foam Filter
2/pack • 6¹/₄" x 1"
OEM# S-290609-00
HCPCS# A7039

GoodKnight 420/425



Item#
CF6003
Ultrafine Filter
2/pack • 1³/₁₆" x 3¹/₁₆"
OEM# M-413950-04
HCPCS# A7038

Item#
CF6003F
Foam Filter
Each • 1³/₁₆" x 3¹/₁₆"
OEM# M-413950-02
HCPCS# A7039

GoodKnight 418 A/G/P/S



Item#
CF6002
Ultrafine Filter
4/pack • 5³/₁₆" x 3³/₄"
OEM# Y-413560-01
HCPCS# A7038

Item#
CF6002F
Foam Filter
6/pack • 5¹/₄" x 3³/₄"
OEM# Y-413560-02
HCPCS# A7039

GoodKnight 418



Item#
CF6001
Ultrafine Filter
4/pack • 2¹/₄" x 1²/₅"
OEM# S-645030-00
HCPCS# A7038

Item#
CF6001F
Foam Filter
6/pack • 2⁷/₁₆" x 1¹/₂"
OEM# S-645029-00
HCPCS# A7039

DEVILBISS

IntelliPAP



Item#
CF5004
Ultrafine Filter
4/pack • 1³/₄" x 1¹/₄"
OEM# DV51D-603
HCPCS# A7038

Item#
CF5004F
Foam Filter
4/pack • 1⁵/₈" x 1³/₁₆"
OEM# DV51D-602
HCPCS# A7039

Horizon LT



Item#
CF5003
Ultrafine Filter
4/pack • 4¹/₄" x 1⁵/₁₆"
OEM# 8000D-603
HCPCS# A7038

Item#
CF5003F
Foam Filter
4/pack • 4¹/₄" x 1⁵/₁₆"
OEM# 8000D-602
HCPCS# A7039

EVO MEDICAL

RemRest



Item#
CF8003F
Foam Filter
3/pack • 2³/₁₆" x 1¹/₁₆"
OEM# 21117
HCPCS# A7039

Comfort PAP



Item#
CF9003
Ultrafine Filter
3/pack • 1³/₁₆" x 1⁷/₁₆"
OEM# 7511
HCPCS# A7038

Item#
CF9003F
Foam Filter
3/pack • 1³/₈" x 1¹/₄"
OEM# 7510
HCPCS# A7039

*All filters can be ordered in any pack quantity.
Contact your sales rep for details.*

HEALTHDYNE

Quest



Item# **CF3003**
Ultrafine Filter
with Curves
5/pack • 4¹/₂" x 4³/₈"
OEM# 7302
HCPCS# A7038



Item# **CF3003F**
Foam Filter
with Curves
5/pack • 4¹/₂" x 4¹/₄"
OEM# 7070
HCPCS# A7039

Tranquility MPR



Item# **CF3002**
Ultrafine Filter
Rectangle/Curve
5/pack • 4⁵/₁₆" x 1⁷/₈"
OEM# 7270
HCPCS# A7038



Item# **CF3002F**
Foam Filter
5/pack
5" x 2¹/₄" x 2¹/₈"
OEM# 7301
HCPCS# A7039

Tranquility



Item# **CF3001**
Ultrafine Filter
5/pack • 5¹/₈" x 1⁷/₈"
OEM# 7170
HCPCS# A7038

INVACARE

Polaris LT



Item# **CF9002**
Ultrafine Filter
3/pack • 5" x 2"
OEM# 1082428
HCPCS# A7038



Item# **CF9002F**
Foam Filter
3/pack • 5" x 2"
OEM# 1082995
HCPCS# A7039

Polaris EX



Item# **CF9001**
Ultrafine Filter
3/pack • 2³/₁₆" x 1"
HCPCS# A7038



Item# **CF9001F**
Foam Filter
3/pack • 2¹/₄" x 1¹/₁₆"
OEM# 1124211
HCPCS# A7039

Polaris TR

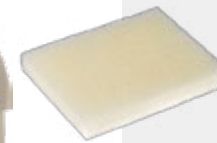

Item# **CF8001**
Foam Filter
2/pack • 2" x 1⁹/₁₆"
OEM# 100446
HCPCS# A7039

PROBASICS

Zzz-PAP



Item# **CF9003**
Ultrafine Filter
3/pack • 1³/₁₆" x 1⁷/₁₆"
OEM# 7511
HCPCS# A7038



Item# **CF9003F**
Foam Filter
3/pack • 1³/₁₆" x 1⁷/₁₆"
OEM# 7510
HCPCS# A7039

*All filters can be ordered
in any pack quantity.
Contact your sales rep
for details.*

SUNSET HCS TUBING

Durable CPAP Tubing 6ft



Item#
TUB006
19mm with 22mm cuffs
HCPCS# A7037



Proudly made in Canada

- Sunset's most popular item
- Compatible with nearly all CPAP, BiPAP and BiLevel systems for every manufacturer on the market
- Smooth interior and a corrugated exterior for excellent flexibility and unrestricted interior flow characteristics
- Injection molded cuffs to reduce tearing
- Low memory to avoid kinks
- BPA-free and latex-free

Compatible with Sunset's new quick release connector!

Item#
CAP1016

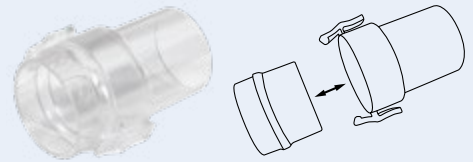

Durable CPAP Tubing 18in

Item#
TUB018
19mm with 22mm cuffs
HCPCS# A7037



Pressure Port Tubing

Item# **TUB006PP**
6ft with Pressure Sensor Lines
22mm Cuffs • HCPCS# A7037

- Built-in sensor line for use with the Puritan Bennett: GoodKnight 420S, 420E and 425 and KnightStar 330



SUNSET CHINSTRAPS

All chinstraps are latex-free • Hand wash only • Lay flat to dry

Universal Neoprene Chinstrap



Item# **CS001**
 Universal Chinstrap
 HCPCS# A7036

- One size fits most
- Attaches to itself at the top of the head
- Can be used with any nasal mask or pillows

Basic Chinstrap



Item# **CS002**
 Compare to
 Resipronics Basic
 OEM# 302175
 HCPCS# A7036

- One size fits most
- Attaches to the top strap of headgear
- Cups the chin for comfort
- Works best with any nasal mask

Adjustable Neoprene Chinstrap



Size	Item#
6in	CS003S
7in	CS003R
8in	CS003M
9in	CS003L
10in	CS003XL

Compare to Puresom
 Adjustable Ruby
 OEM# TMS-09 ADJ
 HCPCS# A7036

- Thin adjustable strap attaches at the top of the head. Thicker bottom strap attaches to itself at the back of the head.
- Great for hard-to-fit patients

For fitting, measure along one side of the head, as indicated by the dashed line above.

Deluxe Chinstrap



Size	Item#
26in	CS004S
28in	CS004L

Compare to
 Resipronics Deluxe
 OEM# 302425
 HCPCS# A7036

- Attaches to itself at the top of the head, two smaller support straps keep the system in place
- Extra-wide strap distributes pressure to add comfort

Comfort Chinstrap



Item# **CS005**
 Compare to
 ResMed Sullivan
 OEM# 16015
 HCPCS# A7036

- One size fits most
- Easy to use —Attaches to itself at the top of the head
- Soft cloth chin cup adds comfort

Premium Chinstrap



Item# **CS006**
 Compare to
 Resipronics Premium
 OEM# 1012911
 HCPCS# A7036

- One size fits most
- Attaches to itself at the top of the head to keep the chin lifted. Smaller support strap attaches to a split section of the chinstrap and wraps around the head for added stability.

SUNSET CHINSTRAPS AND HEADGEAR

All chinstraps and headgear are latex-free • Hand wash only • Lay flat to dry

Ruby Style Chinstrap

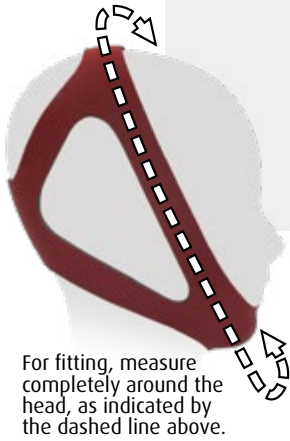

Size	Item#
21.5-22.5in	CS007S
22-23in	CS007M
23-24in	CS007L

Compare to Puresom Ruby
OEM# TMS-09 • HCPCS# A7036

- One piece stretches to slide over the top of the head — no need to Velcro
- Can be used with any nasal mask or pillows

Halo Style Chinstrap



Item# **CS025**
Compare to BreatheWear Halo Chinstrap
OEM# H3407
HCPCS# A7036

Ruby Style Adjustable Chinstrap



Size	Item#
Regular	CS007-ADJ
Extra Large	CS007-ADJXL

HCPCS# A7036

- Fully adjustable
- Super soft materials for extra comfort



Universal Mesh Headgear



Item# **HG001**
Compare to Respironics SimpleStrap Headgear
OEM# 302328
HCPCS# A7035

- One size fits most
- Can be used with most 4-point nasal or full face masks

Universal Headgear



Size	Length	Item#
Regular	22.5in	HG003
Extra Large	24.5in	HG003XL

HCPCS# A7035

- Can be used with most 4-point nasal or full face masks

SOMNIFIX

Mouth Strips

Item#
CAP1017
1 Box
of 28 Strips



SomniFix® Strips reduce open-mouth snoring, and can improve sleep quality, even if patients don't snore.

SomniFix® Strips are non-invasive sleep aids that curb mouth breathing. Unlike chin straps, SomniFix Strips gently adhere to the lips and allow for natural jaw movement while keeping the lips closed to prevent mouth breathing. A smaller breathing vent allows partial airflow.

SNUGZ

Snugz CPAP Mask Liners

Item#
CAP7001
Machine-Washable Liners
for Most Full Face Masks
2/pack

CAP7002
Machine-Washable Liners
for Most Nasal Masks
2/pack



- 2 per pack, 90-day supply
- Machine washable
- Fits MOST nasal or full face CPAP masks (Not recommended for ResMed Mirage Quattro or Respirationics Amara View and Dreamwear)
- Blend of spandex, moisture-wicking polyester and lycra fibers
- Latex-free

Snugz is a machine washable, one-size-fits-most liner for CPAP masks that is designed to help reduce noisy leaks, prevent redness and irritation, and feel great against the skin. The liner helps to grip the skin and keep the mask in place around the nose and mouth, reducing the need for a chinstrap. The improved seal is especially beneficial for high-pressure/high-flow PAP patients and can reduce nightly sleep disturbances and AHI.

REMZZS CPAP MASK LINERS

RemZzzs CPAP Mask Liners

Item#
CAP3001(S,M,L)
Liners for Full Face
ResMed & Respirationics

OEM#	K1-FS	SMALL
	K2-FM	MEDIUM
	K3-FL	LARGE

CAP3004(S,M,L)
Liners for Nasal ResMed
and Fisher & Paykel

OEM#	K10-NS	SMALL
	K11-NM	MEDIUM
	K12-NL	LARGE

30-Day Supply
Boxes sold individually.
Full face and nasal mask RemZzzs include 30 facial liners and 2 forehead liners.

- Increases compliance by adding a comfortable and absorbent pad to CPAP mask
- Reduces air leaks and protects skin from red marks

CAP3002(S,M,L)
Liners for Full Face Fisher & Paykel, Hans Rudolph, and Sunset HCS

OEM#	K4-FS	SMALL
	K5-FM	MEDIUM
	K6-FL	LARGE

CAP3005L
Liners for Respirationics
FitLife Mask

OEM#	6A-FLK	SMALL AND LARGE
	6B-FLK	EXTRA LARGE



CAP3003(S,M,L)
Liners for Nasal
Respirationics

OEM#	K7-NS	SMALL
	K8-NM	MEDIUM
	K9-NL	LARGE

CAP3006
Liners for Nasal Pillows

OEM# 7A-NPK

CAP3007
Liners for Respirationics
DreamWear and Amara View

OEM# 6C-AVK



CPAP BATTERIES

- No additional adapters needed • Outlet functions like a wall socket
- Universal 110-240V recharging conversion • 1-Year Warranty

Zopec Explore 5700

Item#
CAP1024-2157

NEW

Specs

- 1 USB-C (5V/3A) and 2 USB (5V/2.1A) ports
- 2.6 lbs
- 8.5 x 6 x 1 in
- 54,200 mAh /160 Wh
- FAA/TSA compliant (carry-on only)



Zopec Explore 8200

Item#
CAP1024-2182

NEW

Specs

- 1 USB-C (5V/3A) and 2 USB (5V/2.1A) ports
- 3.5 lbs
- 7.75 x 5.5 x 1.75 in
- 80,000 mAh /288 Wh
- Not FAA/TSA compliant (exceeds power capacity)



Zopec Explore Batteries Include

- Universal Wall Charger
 - Fast Car Charger
 - Travel Pouch
- Run any electronics with power requirement of 120 watts or under
 - AutoSwitch and Bypass Technology for uninterrupted sleep when power outages occur
 - Unlimited linking of multiple batteries together for longer use before recharging

Zopec Power Outlet 2

Item#
CAP1024-21ZDP02

Includes battery, wall charger, and travel bag

Specs

- 1 USB-C (45W) and 2 USB (5V/2.1A) ports
- 2.15 lbs
- 7.25 x 5 x 1.75 in
- 40,000 mAh /146 Wh
- FAA/TSA compliant

NEW



CASH ITEMS

CPAP Pillows

Item# **CAP4003**

CPAPMax Pillow

Each OEM# 15-501R-1-920



Cool 3D Mesh Air-Flow
Reduces heat and perspiration



Fiberfill
Soft microfiber pillow top with hypoallergenic fiberfill

CPAPMax Replacement Cover

CAP4003RC

Each OEM# 1-630-101-1-933

Replacement Pillow Case

CAP4003C

Each OEM# 1-626-900-1-02

Item# **CAP4001**

CPAP Pillow

Each

OEM# 14-101R-1-730



CPAP Pillow Replacement Cover

CAP4001RC

Each OEM# 1-626-100-1-00

Replacement Pillow Case

CAP4001C

Each OEM# 1-626-800R-1-00

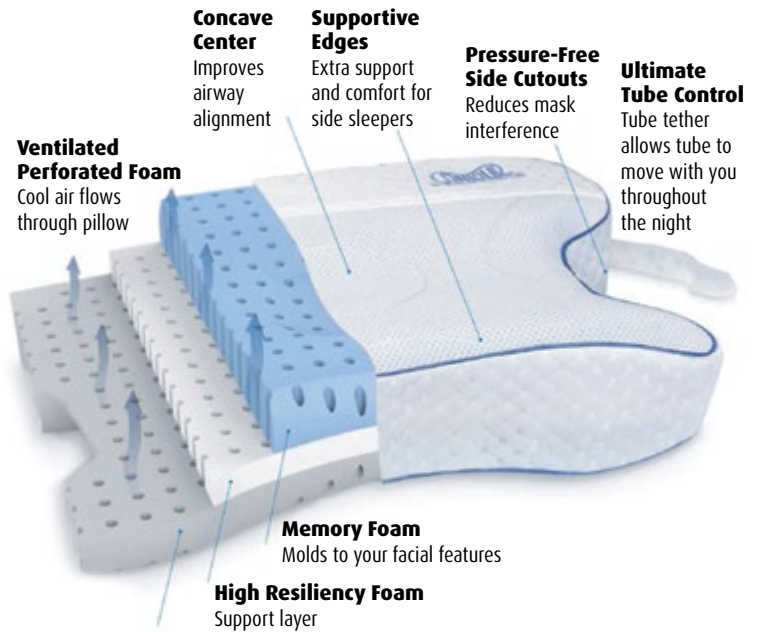

Charcoal Infused High Resiliency Foam

High Resiliency Foam

Charcoal neutralizes odors for freshness every night

BEFORE

Traditional pillows interfere with mask performance and can cause a stiff neck, shifting, leaks, and facial discomfort.



AFTER

The CPAPMax Pillow offers superb mask accommodation, excellent support, and unparalleled comfort.



CPAP Bedside Storage Bag

Item# **CAP1015**

- Well-made and stylish
- Designed to hold CPAP supplies such as a mask and tube
- Weighted lid allows bag to hang off top of nightstand or tabletop

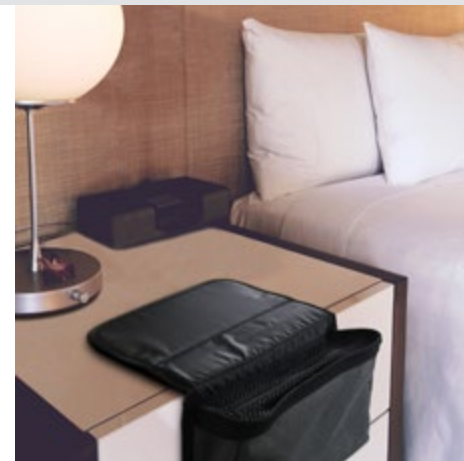

CASH ITEMS

CPAP Moisture Therapy

Item# **CAP6100L**
1oz Tube • **18/cas**



- Formulated to prevent chafing, irritation, dryness or cracking from using a CPAP mask or other delivery device
- Apply to the face at the beginning of treatment and as needed
- Petroleum-free with aloe vera and vitamins A & E

Pur-Sleep CPAP Aromatherapy

Item# **CAP5001**
VaporClear Aromatherapy Starter Kit
OEM# VAPOR

Kit Includes:

- 1 aluminum diffusion stand
- 4 reusable diffusion pads
- 1.5ml bottle of Clear (peppermint, lime)
- 1.5ml bottle of Calm (eucalyptus, lavender, rosemary)



30ml Aromatic Refills

Scent/OEM#	Item#
Black Cherry	CAP5004-BCH
Calm	CAP5004-CLM
Clear	CAP5004-CLR
Dark Chocolate	CAP5004-DCH
Deep	CAP5004-DEE
French Vanilla	CAP5004-FRV
Fresh	CAP5004-FSH
Peace	CAP5004-PCE
Spice	CAP5004-SPC
Strawberry	CAP5004-STR

Item# **CAP5002**
Reusable Diffusion Pads
10/pack • OEM# DP10

Item# **CAP5003**
Replacement Aluminum Diffusion Tray
Each • OEM# TRAY

- Aromatherapy products specifically for use with CPAP
- Set up the diffuser right below the CPAP filter intake, add a drop of essential oil to the pad and the fragrance is drawn into the CPAP machine



Quick Tube Release Connector

Item# **CAP1016**
Each

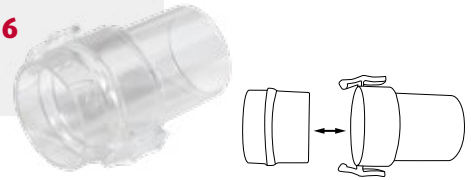

CPAP Final Bacteria Filter

Item# **BF2200**
22mm Bacteria Disk Filter
5/pack



Attach between the machine and tube for additional protection against bacteria and allergens

Circuit Connectors

Item# **RES013**
22mm OD x
15mm ID/
22mm OD
10/pack



Item# **RES014**
22mm OD x
22mm OD
With Lip
10/pack



Humidifier Tubing Adapter

Item# **RES016**
22mm ID x
22mm OD
with Lip
10/pack



Oxygen Bleed-In Adapter

Item# **RES019**
22mm with
6mm Stem
10/pack



- Barbed rotating stem
- Used for oxygen bleed-in

TUBING WRAPS

Comfort Tubing Wrap



Item#
CAP2001
6ft Velour
Tubing Wrap
Each
Compare to
Respironics
Tubing Wrap

- 6ft plush velour material adds comfort while preventing rainout
- Zipper closure for ease of use

Both Tubing Wraps come in attractive retail packaging



Deluxe Tubing Wrap



Item#
CAP2002
6ft Nylon
Tubing Wrap
Each
Compare to ResMed
Tubing Wrap

- 6ft nylon wrap with fleece lining maximizes heat retention and reduces noise
- Zipper closure for ease of use

CPAP SUGGESTED REPLACEMENT SCHEDULE

Item	Recommended replacement schedule
Heated Circuit Tubing	1 per 3 months
Combination Oral/Nasal Mask	1 per 3 months
Replacement Oral Cushion for Combination Oral/Nasal Mask	2 per month
Replacement Nasal Pillows for Combination Oral/Nasal Mask — Pair	2 per month
Full Face Mask	1 per 3 months
Replacement Full Face Mask Cushion or Liner	1 per month
Replacement Nasal Cushion or Liner	2 per month
Replacement Pillows — Pair	2 per month
Nasal or Pillows Mask	1 per 3 months
Headgear	1 per 6 months
Chinstrap	1 per 6 months
Tubing	1 per 3 months
Filter — Disposable	2 per month
Filter — Nondisposable	1 per 6 months
Oral Interface	
Replacement Exhalation Port	
Replacement Water Chamber	1 per 6 months
Monitoring Feature/Device	
BiLevel Device without Backup Rate	
BiLevel Device with Backup Rate	
Humidifier - Non-Heated	
Humidifier - Heated	
CPAP Device	

We can cross-reference any OEM numbers for you. This is just one of our many free services to help make doing business easier. We're always glad to talk, so give us a call today.

RoEZIt AND CPAP MOISTURE THERAPY



Item#
RES6104L
1oz Tube
18/case

Item#
CAP6100L
1oz Tube
18/case

- Prevent chafing, irritation, dryness or cracking from using a CPAP or oxygen delivery device
- Apply to the face at the beginning of treatment
- Petroleum-free with Aloe Vera and Vitamins A & E

Oxygen	Page
Firesafe	32
Masks	33
Pulse Oximeters	33
Cannula	34-35
Cylinder Carriers	36-37
Accessories	38-39
Conserver	38
Cleaners	39
Concentrator Cabinet Filters	40-43
Caire/AirSep/Sequal	40
CHAD	40
Covidien Nellcor Puritan Bennett	41
DeVilbiss/Drive	41
Inogen	42
Invacare	42
Nidek	42
Respironics/Healthdyne	43
3B	43

OXYGEN PRODUCTS

FIRESAFE

Firesafe Thermal Shut-Off Valve

Item# **RES010F-20**
Each

- Bidirectional



CASH ITEM

- A thermal fuse designed to stop the flow of gas in the event that the downstream oxygen tubing is ignited
- Helps protect against oxygen tubing fires
- Helps keep patients safe no matter what method of oxygen delivery they use
- Offers a cost-effective solution to lower the risk of serious patient injury in an oxygen fire

FireSafe Tubing Connector

Item# **RES010TC** 100/case



FireSafe Nozzle

Item# **RES010FND-20**
20/pack

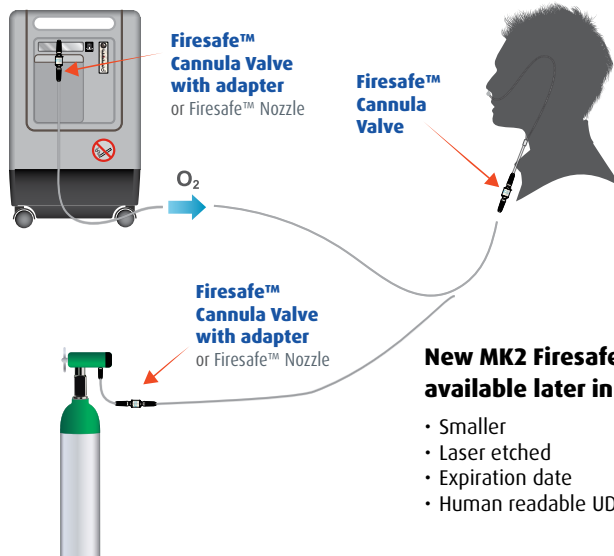

Phone 1-312-533-2455

Fax 1-312-724-7650

Email bvigna@sunsethcs.com

MASKS

Simple O₂ Mask



With 7ft Safety Tubing

Item# **RES2100**
Adult Size
50/case

Item# **RES2200V**
Pediatric Size
50/case



HCPCS# A4620

- 5-12 LPM
- Medium concentration
- Clear, soft vinyl for patient comfort
- Adjustable nose clip for secure seal

Partial Rebreather O₂ Mask



With 7ft Safety Tubing & Reservoir Bag

Item# **RES2101V**
Adult Size
50/case

Item# **RES2201V**
Pediatric Size
50/case



HCPCS# A4620

- 5-15 LPM
- High concentration

Non-Rebreather O₂ Mask



With 7ft Safety Tubing & Reservoir Bag

Item# **RES2102V**
Adult Size
50/case

Item# **RES2202V**
Pediatric Size
50/case



HCPCS# A4620

- 10+ LPM
- Low-resistance check valves prevent rebreathing and allow exhaled gas to escape

PULSE OXIMETERS

Advanced Finger Pulse Oximeter

Item# **RES5101**
Each



- 6 display modes
- Dual color OLED display
- SpO₂, PR, pulse bar and waveform



CASH ITEM

Both Pulse Oximeters

- 2-year warranty
- Ergonomic design
- Adult and pediatric use
- Low power consumption — automatically powers off
- Easy and convenient to operate and carry
- More than 30 hours of operation on 2 AAA batteries — included
- Light and compact



Both Pulse Oximeters come in attractive retail packaging

Standard Finger Pulse Oximeter

Item# **RES5100**
Each



CASH ITEM

- 1 display mode
- Digital LED display
- SpO₂, PR, and pulse bar



OXYGEN MASKS AND FINGER PULSE OXIMETERS

SUNSET HCS

Standard Cannula



- 1-6 LPM
- Curved nasal prongs for added comfort
- 6-channel safety tubing is kink-free
- Soft, lightweight material is memory free for long-term comfort

Adult Standard Cannula

Length	Item#	Qty
0ft	RES1100V	50/case
4ft	RES1104V	50/case
7ft	RES1107V	50/case
15ft	RES1115V	50/case
25ft	RES1125V	25/case



Item# **RES1207V**
 Pediatric Cannula with 7ft Supply Tube
50/case



Item# **RES1307V**
 Infant Cannula with 7ft Supply Tube
50/case

HCPCS# A4615

Soft Cannula

Adult Soft Cannula

Length	Item#	Qty
7ft	RES1107S	50/case



- Designed to reduce pressure and friction against skin
 - Perforated bag for easy opening
- HCPCS# A4615

Cannula Ear Cushions

Item# **RES020**
 Cushions Only
50 Pairs/case

- Add cushions to existing cannula



Secure Cannula Stickers

Item# **RES080**
25 pairs/case

- Holds cannula in place
- Easy to use
- Flexible, sheer fabric
- Designed to let skin breathe and peel off without leaving residue
- Latex-free
- Individually wrapped pairs

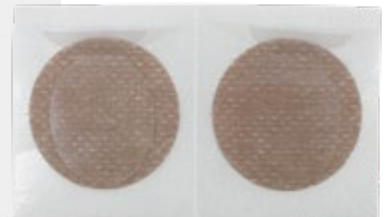

Dual-Lumen (Demand) Cannula



Adult Dual-Lumen (Demand) Cannula

Length	Item#	Qty
4ft	RES4144V	25/case
7ft	RES4144V	25/case

HCPCS# A4615

- 1-6 LPM
- Designed for use with dual port oxygen conservation delivery systems
- Face piece redesigned with a single set of prongs for added comfort
- Dual tubing set provides independent tubes for oxygen delivery and sensing of patient breathing

High Flow Cannula



High Flow Cannula

Length	Item#	Qty
4ft	RES1104HFV	25/case
7ft	RES1107HFV	25/case
15ft	RES1115HFV	25/case

HCPCS# A4615

- 6-15 LPM
- Maintain saturation for high-flow patients without a mask
- 6-channel supply tubing for safety

Tabbed Cannula



Item# **RES1007V**

Adult Tabbed Cannula with 7ft Supply Tube
50/case

HCPCS# A4615

- 1-6 LPM
- Tab helps to grasp nares

Sample Oxygen Cylinder Specifications*

Use the handy chart below to determine which accessories to purchase for your oxygen cylinder.

* This information is intended to be used as a guide. Dimensions may vary by manufacturer. Sunset Healthcare Solutions does not sell oxygen tanks.



Older Name		A	B			C	D	JD	E		
Newer Name	M2	M4	M6	ML6	M7	M9	M15	M22	M24	M60	M/MM/M122
Diameter (in.)	2.5	3.2	3.2	4.3	4.3	4.3	4.3	5.3	4.3	7.3	8
Height (in.)	5.3	8.5	11.5	7.6	9.1	11	16.5	16.5	25.5	23	36
Empty Weight (lb)	0.7	1.6	2.2	2.8	3.3	3.7	5.3	8	7.9	22.3	39.5
Capacity (L)	42	113	164	165	198	255	425	640	680	1738	3455
Transport Method	CSBM6, CSBM6BP	CSBM6, CSBM6BP	CSBM6, CSBM6BP, CSBM6Flex, CSBM6-Carrier	CSBML6M7, CSBML6-Hardshell	CSBML6M7	CSBM9, CSBM6BP, CSBM6Flex, RES038B	CSBD, CSBDBP, CSBD1Roller, CSBD2Roller, RES038B, RES060		CSBE, CSBD1Roller, CSBD2Roller, RES038B, RES060	Not Portable	Not Portable
Regulator Type	RES042, RES043	RES042, RES043	RES042, RES043	RES042, RES043	RES042, RES043	RES042, RES043	RES042, RES043	RES042, RES043	RES042, RES043	RES044, RES045	RES044, RES045

CYLINDER BAGS

Comfort Shoulder Bags

Cylinder	Item#
ML6/M7	CSBML6M7
C/M9	CSBM9
B/M6	CSBM6
D	CSBD



- Comfort flex shoulder strap
- Double zipper for easy access
- Machine washable



CSBML6M7

CSBM9

CSBM6

CSBD

Flex 02 Bag

Item# **CSBM6Flex**
 Reconfigurable Bag
 for M6 and M9
 Cylinders
Each

- Adjusts to 5 carrying modes



Backpack

Cylinder	Item#
B/M6/C/M9	CSBM6BP
D	CSBDBP



- Fully adjustable and comfortable backpack straps
- Machine washable
- Converts to either backpack or shoulder bag

Wheelchair/Scooter Carrier

Item# **CSBE**
 For E Cylinders
Each



- Multi-part stabilizer straps for easy chair attachment
- Machine washable

CYLINDER CARRIERS

Single Tank Rolling Bag/Backpack

Item#
CSBD1Roller
For D/E Cylinders
Each



CASH ITEM



Double Tank Rolling/Shoulder Bag

Item#
CSBD2Roller
For D/E Cylinders
Each



CASH ITEM

• May also be used with shoulder strap



ML6 Hardshell Tote

Item#
CSBML6-Hardshell
For Homefill Cylinders
Each



CASH ITEM



Cylinder Rack

Item# **RES038B**
Each
For D, E, or M9 Cylinders —
Lightweight, Durable
Plastic Composite Rack



Oxygen Cylinder Carrier

Item#
CSBM6-Carrier
Each
Soft Polyester Tote
for M6 Cylinders



- Tote handles
- Padded shoulder strap
- Fastening strap for mobility
- Holds up to 8 M6 tanks

D/E Cart

Item#
RES060
4/case

- Accommodates one D or E tank
- Sturdy yet lightweight (4.18 LBS welded metal construction)
- Adjustable height handle with PVC grip
- Large EVA Foam wheels have just the right amount of resilience for good traction and maneuverability
- Elegant, grey satin finish
- Bottom fork rest with rubber caps

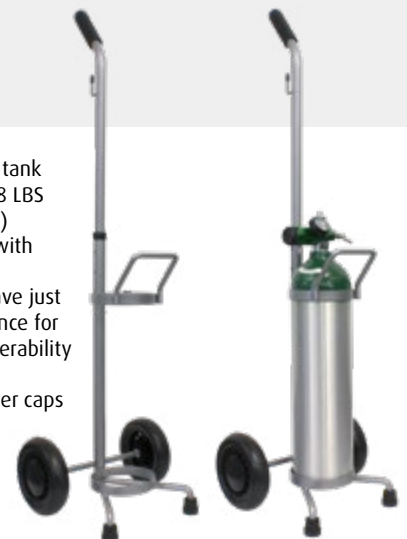

ACCESSORIES AND CONSERVER

Homefill Tubing Connector

Item# **RES039**
10/pack

- Compatible with Invacare, Drive, and Respiration homefill machines
- Durable, coiled tubing



Homefill Racks

Item# **RES039-RACKB**
For Invacare Perfecto2
4/case

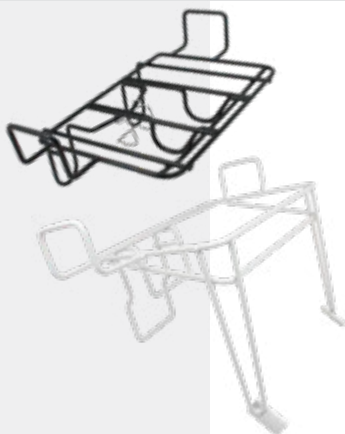

RES039-RACKW
For Invacare Platinum
4/case

RES039-RACKD
For DeVilbiss 525/1025 Series
4/case

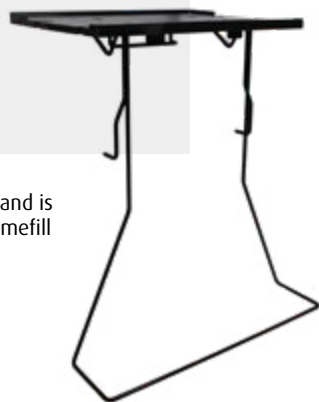

Easily attaches onto concentrator and is designed to conveniently hold Homefill and transfill oxygen systems.

Oxygen Liter Meter

Item# **RES034**
0-10 Liter/Minute
Each



- Oxygen pen
- Works with tanks and concentrators

Bonsai Pneumatic Conserver

Item# **RES049**
Single Lumen • Barbed Outlet
Each



- Delivers a uniform oxygen pulse at increments: 1, 2, 3, 4, 5, and 6
- Two continuous flow (CF) settings preset @ 2 LPM and 4 LPM
- Delivers up to a 6:1 savings ratio from 14-40 breaths per minute
- Senses breath/delivers oxygen in first half of inspiratory cycle
- Operating pressure range: 200-3000 PSI
- Light weight and quiet operation
- Easy to operate single selector knob
- Compact design fits easily in virtually any oxygen carry bag
- Limited 2-year warranty

RoEzIt Dermal Care

Item# **RES6104L**
1oz Tube • 18/cas



\$
CASH ITEM

- Apply before beginning oxygen therapy and as needed during treatment
- Moisturizes the nose, lip, and over the ear where friction may cause discomfort from cannula
- Petroleum-free with aloe vera and vitamins A and E

ACCESSORIES AND CLEANERS

Oxygen In Use Signs

Item# **RES003**
6in x 9in
With String
50/pack

- Double-sided (English and Spanish)



Washers with Rubber Ring

Item# **RES035**
Brass
25/pack



Item# **RES036**
Aluminum
25/pack



Humidifier Connectors

Item# **HUM008**
L-Connector 12in • **10/pk**

Item# **HUM008L**
L-Connector 21in • **10/pk**

Item# **HUM008S**
Straight Connector 12in • **10/pk**

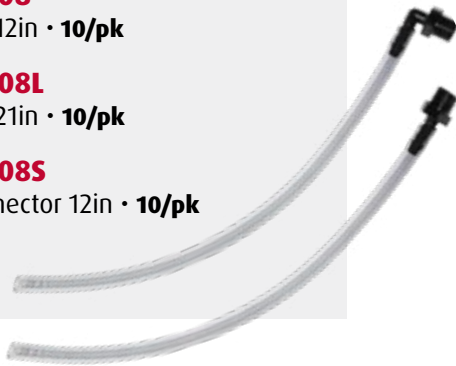

Wrenches

Item# **RES031**
With Chain **10/pack**

Item# **RES032**
Without Chain **10/pack**

Item# **RES031M**
Metal Wrench with Chain
for Post Valve Oxygen
Cylinders and CGA 540
Style Regulators
5/pack



- For use with post valve oxygen cylinders: A, B, C, D, JD or E tanks
- Made of tough, stress-resistant nylon

Germicidal Deodorizing Cleaner

Item# **RES6100**
12/case
22oz spray bottles

- Heavy duty cleaner contains no bleach, alcohol, or phenols
- An effective bactericide, virucide, and fungicide
- Formulated to disinfect hard, non-porous surfaces



Germicidal Deodorizing Wipes

Item# **RES6101**
6/case
(Dispensers of 125 wipes)

- Cleans, disinfects, and deodorizes hard, non-porous surfaces
- Fresh citrus scent
- Kills 99.9% of bacteria



Germicidal Deodorizing Cleaner — Gallon

Item# **RES6102**
1 Gallon

- No-scrub, hospital strength germicidal cleaner
- Cleans, deodorizes, and disinfects surfaces, equipment and non-critical instruments



Visit www.sunsethcs.com



CAIRE/AIRSEP/SEQUAL

CAIRE Companion 5



Item# **BF1103**
Extended Life Intake
Bacteria Filter
Each
OEM# 2185



AirSep Newlife, QuietLife, Intensity



Item# **OF8002**
Foam Cabinet Filter
10/pack
5 1/4" x 4 7/8" x 7/8"
OEM# F1-50-08-05



Item# **OF8001**
Felt Filter
10/pack
17/8" OD x 3/4" ID x 1"
OEM# M1 161-1

SeQual Integra



Item# **OF11005**
Foam Cabinet Filter
10/pack
7 5/8" x 3 5/8" - 5 x 3/4"
OEM# 2185

SeQual Eclipse

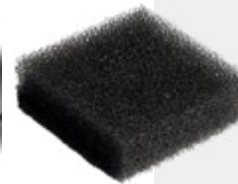

Item# **OF11006**
Foam Cabinet Filter
10/pack
2 1/2" x 2 1/2" x 3/4"

CHAD

Total O₂



Item# **OF11007**
Foam Cabinet Filter
10/pack
4 3/8" x 4" x 3/4"



Item# **OF3003**
Foam Intake Filter
for use with BF2222
10/pack
2 5/8" OD x 3/4" ID x 2 3/8"
OEM# H613

COVIDIEN NELLCOR PURITAN BENNETT

590 and 592A



Item# **OF6001**
Foam Cabinet Filter
10/pack
6³/₄" X 4¹/₄" X 3⁸/₈"
OEM# 492672

DEVILBISS/DRIVE

SolAiris III, 303 Series



Item# **OF5004**
Foam Cabinet Filter
10/pack
3³/₄" X 3³/₄" X 1²/₂"
OEM# 30302605

1025 Series



Item# **OF5004**
Foam Cabinet Filter
10/pack
3³/₄" X 3³/₄" X 1²/₂"
OEM# 303DZ-605

SolAiris V, 505, 515 Series



Item# **OF5005**
Foam Cabinet Filter
10/pack
5¹/₂" X 3⁵/₈" X 5⁸/₈"
OEM# 50502694

525 DS Series



Item# **OF5004**
Foam Cabinet Filter
10/pack
3³/₄" X 3³/₄" X 1²/₂"
OEM# 303DZ-605

All MC Units



Item# **OF5001**
Foam Cabinet Filter
10/pack
6¹/₈" X 3¹/₂" X 1⁴/₄"
OEM# 444-514

INOGEN

One



Item# **OF11008**
Foam Cabinet Filter
10/pack
2 1/4" x 3/4" x 1/2"
OEM# RP-100

INVACARE

Mobilaire 3 and 5



Item# **OF9001**
Foam Cabinet Filter
10/pack
6 3/4" x 3 3/8" x 1/2"
OEM# 2000489

Platinum 5 and 10



Item# **OF9002**
Foam Cabinet Filter
10/pack
9" x 2 7/8" x 1/2"
OEM#1107412

Perfecto₂



Item# **OF9004**
Foam Cabinet Filter
10/pack
6 7/8" x 3 3/4" x 1/2"
OEM# 1143492

HomeFill



Item# **OF9003**
Foam Cabinet Filter
10/pack
6 3/4" x 3 1/4" x 1/2"
OEM# F200489

NIDEK

Nuvo



Item# **OF11003**
Foam Cabinet Filter
10/pack
9 1/2" x 4" x 1/4"
OEM# 9250-1025

Mark IV, V, V+



Item# **OF11004**
Foam Cabinet Filter
10/pack
10" x 4" x 1/2"
OEM# 9007-6G37

RESPIRONICS/HEALTHDYNE

EverGo



Item# **OF1005**
Foam Cabinet Filter
10/pack
2³/₁₆" x 11¹/₁₆" x 3³/₈"
OEM# 900-150

EverFlo



Item# **OF1006SP**
Cabinet Filter Kit
(No Cover)
2 Filters, 1 Casing
OEM# 1055625



Item# **OF1006**
Cabinet Filter
10/pk
5¹¹/₁₆" x 4¹/₂" x 7¹/₁₆"



Item# **OF1006-CASE**
Foam Cabinet Filter
Casing
10/pack

Millennium



Item# **OF1001**
Foam Cabinet Filter
10/pack
8¹/₄" x 4" x 3³/₈"
(3³/₁₆" notches)
OEM# H619



Item# **OF3003**
Foam Intake Filter
10/pack
2⁵/₈" OD x 3³/₄" ID x 2³/₈"
OEM# H618



Item# **OF1002**
Felt Filter
6/pack

Alliance



Item# **OF3002**
Foam Cabinet Filter
10/pack
8¹/₄" x 3³/₄" x 1¹/₂"
OEM# 100-0078-10



Item# **OF3003**
Foam Intake Filter
for use with BF2222
10/pack
2⁵/₈" OD x 3³/₄" ID x 2³/₈"
OEM# H618

3B

Stratus 5



Item# **OF6030**
Foam Cabinet Filter
10/pack
OEM# STR1030

OTHER

Other	Page
Nebulizers	45
Aerosol	45
Nebulizer Filters	46
PPE	46
Mobility	47

NEBULIZERS

Rechargeable Mini Mesh Nebulizer

Item#
NEB401

NEW

Included

- Main unit
- Medicine cup
- Disposable mouthpiece
- Disposable adult mask
- Disposable pediatric mask
- USB cord
- Carrying bag
- Instruction manual



Small particle size
MMAD 2.2µm*

Efficient
Low Residual Liquid

Convenient
Small and Portable

Quiet
≤50dB (at one meter)

Modern
Rechargeable Lithium Battery

Power Input USB (5VDC Min 1.5A)
Rechargeable Lithium Battery 3.7VDC 1800mAh
Frequency 110KHz±10%
Nebulization Rate ≥0.2mL/min
Sound Level ≤50dB (at one meter)
Medicine Liquid Temperature ≤140°F

Replacement Parts

NEB401-CUP	Medication Cup
NEB401-MP	Mouthpiece
NEB401-MASKP	Pediatric Mask
NEB401-MASKA	Adult Mask

Handheld Compressor Nebulizer



Item#
NEB200

Included

- Compressor
- Medication cup
- AC power adapter
- Air hose
- Elbow
- Mouthpiece
- Mask
- 4 AA batteries

- Runs on 4 AA batteries or AC power adapter
- Portable (small and weighs only 1/2 pound)
- Quiet (60dBA)
- Fine particle size (Approximately 3 microns)
- No replacement filter required

AEROSOL

Aerosol Mask

Item# **RES2110**
Adult Size
50/case

Item# **RES2210**
Pediatric Size
50/case

HCPCS# A7015



- Clear, soft vinyl for patient comfort
- Adjustable nose clip for secure seal
- Connector accepts 22mm aerosol tubing
- Individually packaged

Aerosol Tube

Item# **TUB100-6**
Corrugated Aerosol Tubing
100ft in 6in segments



Aerosol Tube — Blue

Item# **TUB100-6B**
Corrugated Aerosol Tubing — Blue
100ft in 6in segments

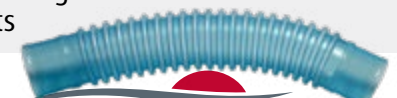

NEBULIZER FILTERS

Plastic Intake Filter

Item# **BF015**
10/pack
 HCPCS# A7013



Plastic Intake Filter with Head

Item# **BF016**
10/pack
 HCPCS# A7013



Plastic Intake Filter with Head

Item# **BF017**
5/pack
 HCPCS# A7013



Foam Filter

Item# **BF018**
10/pack
 HCPCS# A7013



Nebulizer Filter Compatibility

Caire

Medi-Mist	BF018
-----------	-------

DeVilbiss

PulmoNeb	BF017
PulmoNeb LT	BF017
Sunrise Compact	BF018
Pulmo-Aide	BF017
Pulmo-Aide Compact	BF017
PulmoMate	BF017

Evo

AeroMax	BF018
SportsNeb	BF018
Super SportsNeb	BF018

Invacare

Passport	BF018
Envoy	BF018
Envoy Jr.	BF018
Select	BF018

John Bunn

Nebulite EV	BF018
LT2	BF018
LX	BF018

MedLine

SportsMist	BF018
------------	-------

Respironics

Inspiration 323	BF015
Inspiration 626 & 929	BF016
MisterNeb	BF016
Inspiration Elite	BF016
MiniElite	BF018

Salter

AIRE Plus	BF018
-----------	-------

Schuco

2000	BF018
3000	BF018

Sunset

NEB100 Series	BF018
NEB300 Series	BF018

PPE

Alcohol Wipes

Item#
CAP1003A
56 packs of 50 wipes/case

• 75% Isopropyl Alcohol



Mini Pistol Grip Non-Contact Thermometer

Item#
PPE4001-J
 Infrared
Each

- Forehead mode for all ages
- Object measurement mode
- HD LCD display
- Battery: AAAX2
- Fever warning: 6 short double beeps
- Memory storage: 20 sets of measureable data
- Fahrenheit and Celsius
- Automatic shutdown: 10 seconds
- Professional accuracy (plus or minus 0.6 degrees F when measuring forehead temperatures from 89.6 through 107.9 degrees F)



KNEE SCOOTER

Deluxe Knee Scooter

Item#

MOB100

Steerable, with basket

HCPCS# E0118



- Dual rear wheel brakes with parking brake feature
- Steerable
- Foldable for easy storage and transport
- Indoor/outdoor
- Adjustable height handlebar and knee pad
- Contoured knee pad
- Large 7in wheels

Replacement Parts

MOB100-WHEELS	Wheels (Pair)
MOB100-KNEEPAD	Knee Pad
MOB100-BRAKEHANDLE	Brake Handle
MOB100-BRAKECABLE	Brake Cable
MOB100-BASKET	Basket

Frame Warranty	3 years
All Other Components Warranty	1 year
Max Weight Capacity	350 lbs
Basket Max Weight Capacity	10 lbs
Brake System	Dual Rear Wheel Brakes
Wheel Size	7in
Handle Height	31in - 40in
Knee Pad Height	16.5in - 20.5in
Weight	22 lbs



The MOB100 Deluxe Knee Scooter provides an easy, portable way to keep up with daily activities after foot or ankle surgery, sprains, amputations or other leg impairments. It's equipped with a basket for transporting items up to 10 pounds. The steel frame is foldable for easy storage and transport.

The adjustable steering tiller provides optimum mobility and control when on the go. When resting, the parking brake system can lock the wheels in place. The padded knee platform features a contoured cushion for stability and comfort and is easily customized using the height adjustment knob.

WHEELCHAIR CUSHIONS

Foam and Gel Wheelchair Cushions

Foam 16x3x • Each

Size	Item#
16in	WCF16163
18in	WCF18163
20in	WCF20163

Gel 16x3x • Each

Size	Item#
16in	WCG16163
18in	WCG18163
20in	WCG20163

HCPCS# E2601

- Supports up to 250 lbs
- Breathable, washable, waterproof cover
- Fire-retardant materials
- Retail packaging is attractive and stackable with easy size and type identification shown on the side

Foam is lightweight

Gel includes a gel bladder inside the foam for more support



Lumbar Cushion

Item#

WCL18

18in • Each

HCPCS# E2611



High quality memory foam gives Sunset's wheelchair lumbar cushion an added level of comfort. In addition to easing back pain, the lumbar cushion also helps maintain spine alignment. A removable cover makes washing easy and quick.

Visit www.sunsethcs.com



