



MAGNET GROUP
YOUR OTHER GPO For Quality Medical Contracts

AGREEMENT #3425

Product Catalog



Area Business Director
Jackson Hanft
 C: 971-416-6695
 jackson@sunsethcs.com

Senior Area Business Director
Bryan Eckard
 C: 215-375-5765
 beckard@sunsethcs.com

Director, Strategic Accounts
Lisa Iannazzone
 C: 636-222-3134
 lisa@sunsethcs.com

Sales Representative
Egle Sventnickaite
 O: 872-258-1654
 esventnickaite@sunsethcs.com

Sales Representative
Owen Ruth
 O: 312-533-2451
 oruth@sunsethcs.com

Director, Sales Operations
Mark Lipson
 C: 248-981-9669
 O: 312-533-2465
 mlipson@sunsethcs.com

Sales Representative
Christian Straussner
 O: 872-282-0746
 C: 847-525-6340
 cstraussner@sunsethcs.com

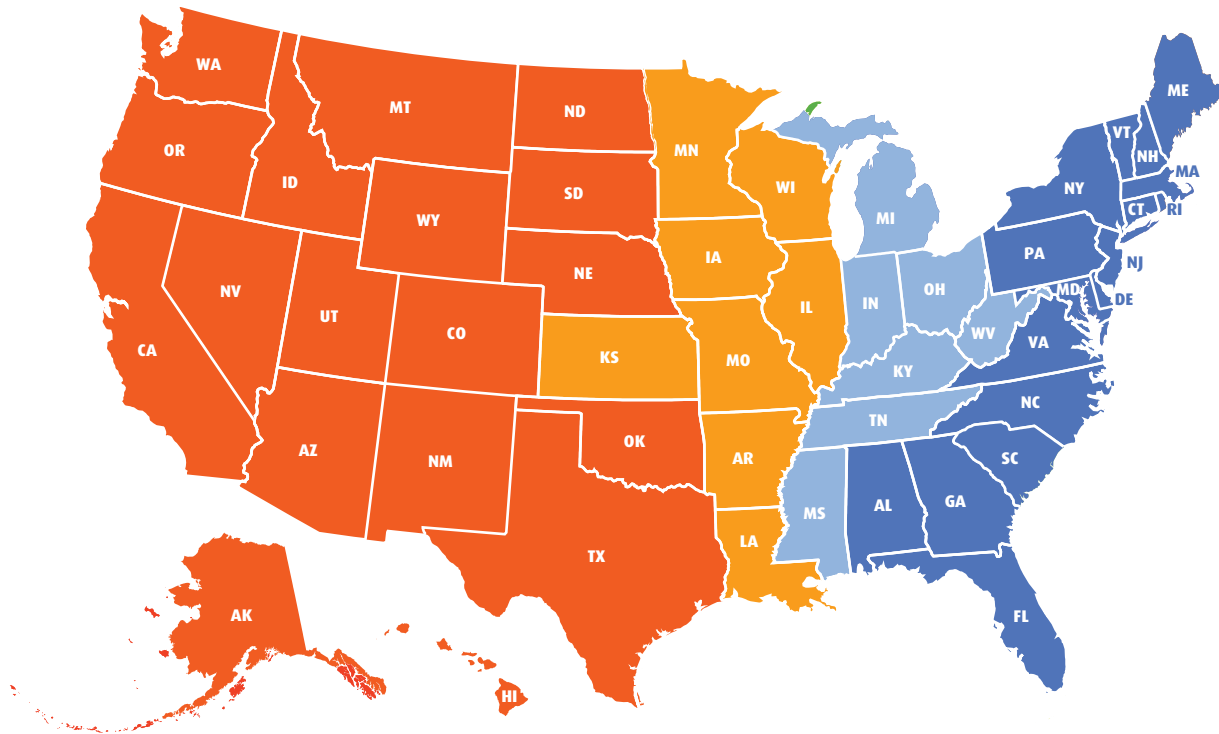

Corporate Office

Phone 872-275-3210
 Fax 312-997-9985
 180 N Michigan Ave Ste 2000
 Chicago, IL 60601

Central Returns/Distribution Center

279 Madsen Dr Ste 101
 Bloomingdale, IL 60108

West Returns/Distribution Center

6750 W Van Buren St
 Phoenix, AZ 85043

CONTENT

Innovative Technology Page

GuideBlade	4
PeDIA	5
Anestand	6-7

CPAP Page

Masks and Replacement Parts	8-16
Sunset Healthcare Solutions	8-10
Sleepnet	11-13
Circadiance	14-15
InnoMed	16
Airway Management	16
Sleep Apnea Appliances	17
Tubing	18-19
Filters	20-28
Respironics	20-21
ResMed	22-23
Fisher & Paykel	24
3B	24
AEIOMed	25
Breas/GE	25
CareFusion/Viasys	26
Covidien Nellcor Puritan Bennett	26
DeVilbiss	27
Evo Medical	27
Healthdyne	28
Invacare	28
ProBasics	28
Humidifier Chambers	29
Chinstraps	30-31
Headgear	31
Cash Items	32-39
Cleaners and Accessories	32-33
Batteries	34-35
Mask Liners and Soft Headgear Covers	36
Self Care	37
Connectors, Adapters, and Inline Filter	37
Pillows	38
Storage	38
Pressure Meter	39
Tubing Wraps	39

Oxygen Page

Pulse Oximeter	40
Firesafe	41
Concentrators	42
Batteries	42
Masks	43
Cannula	44-45
Tubing	45
Regulators and Conserver	46
Cylinder Carriers	48-49
Connectors and Adapters	50
Accessories	50-52
Cleaners	52
Bacteria and HEPA Filters	53
Concentrator Cabinet Filters	54-59
Caire/AirSep/SeQual	54
CHAD	55
Covidien Nellcor Puritan Bennett	55
DeVilbiss/Drive	56
Inogen	57
Invacare	57
Jumao, Lifestyle, Attendant	58
Nidek	58
3B	58
Respironics/Healthdyne	59

Other Page

Aerosol	61
Tabletop Nebulizers	62-63
Handheld Nebulizers	63
Nebulizer Kits	64
Nebulizer and Anesthesia Filters	65
Suction	66-69
Tracheostomy	70
Ventilator Filters, Masks, and Connectors	71
Ventilator Circuits	72-73
StrongArm Comfort Cane	74
Bath Safety	75
PPE	76-78
Maternity	79

GUIDEBlade™

Precise, on the wire incisions for guidewire assisted catheter insertion

GuideBlade—Precision Incisions, Every Time!

Evaluation of the efficacy and safety of a novel dermatotomy device for central venous cannulation

Worasak Keeyapaj, MD., Albert T. Cheung, MD.

Department of Anesthesiology, Perioperative and Pain Medicine, Stanford University, Stanford, California

Outcome	Number (%)
Primary outcome: Successful lines insertion without additional instrument	188 (100%)
Wire damage	0 (0%)
Operator injury	0 (0%)



About the GuideBlade™

The GuideBlade™ is the only disposable scalpel on the market engineered specifically to streamline over the wire vascular access placement. The GuideBlade™ allows clinicians to perfectly align the dermatotomy incision made during vascular access placement with the in situ guidewire. This alignment prevents residual skin tags and eliminates the need for dermatotomy revisions.

GuideBlade™ Clinical Benefits

- Less insertion site bleeding.
- Maintenance of insertion site skin integrity.
- Decreased risk of catheter bacterial colonization.
- Decreased risk of wire related complications (wire fracture and wire kinking).
- Decreased scarring/improved cosmetic result.

GuideBlade™ In Practice

- Appropriate for use with guidewires up to and including 0.035" diameter.
- Useful for placement in a wide range of venous access devices including central venous catheters, PICC lines, venous introducer sheaths, hemodialysis catheters, and percutaneous ECMO cannulas.
- Particularly useful in procedures placed while wearing protective faceshields where condensation and glare can obscure visualization of the guidewire insertion site.
- Particularly useful in obese or bleeding patients where wire entry site can be obscured by excess soft tissue or entry site bleeding.
- Increased benefit when used by trainees and less experienced practitioners.

The GuideBlade™ Value Proposition

- Decreases the need to replace kit components (like guidewires, dilators or catheters) that are easily damaged by residual skin tags often seen with standard disposable scalpel use.
- Decreases insertion site bleeding, thereby decreases the need for frequent dressing changes.
- Maintains skin integrity and thereby decreases risk of catheter colonization and associated infection.

Misaligned skin incisions make passage of dilators and catheters difficult and can lead to guidewire kinking and fracture. Revision of incisions may increase the risk of insertion site bleeding, scarring and catheter associated bloodstream infection.



Stop “brutane” mask induction and turn panic into play

Item#

ANEP001B	Blue
ANEP001Y	Yellow
ANEP001P	Purple

Instructional videos for children available in English and Spanish



For children, the process of undergoing surgery is already unsettling, and the process of mask-based induction is often the most traumatizing part. Often kids will kick and scream rather, believing they’re being trapped by the gas or suffocated by the mask. The experiences create negative emotional scarring that can last weeks, months or even years.

With the introduction of the revolutionary Pediatric Device for Induction of Anesthesia device, or “PeDIA” for short, that stress and anxiety can be replaced with something colorful and fun.

As the world’s first mask-free system and method for inhalation induction, the PeDIA provides a solution to this problem that anesthesia providers have been researching for decades. It replaces the mask with a colorful balloon, which actually allows the child to put themselves to sleep rather than being forced to submit to an unfamiliar mask.

PeDIA resolves the problems of traditional mask induction while fostering a sense of trust and patient satisfaction.



Customized anesthesia workstation for every anesthetizing location

Item#

ANE77006

Anestand Anesthesia Stand, Complete Tray and Clamp

ANE77001 Replacement Tray

ANE77005 Replacement Clamp

Benefits to Providers

- Keep medications near IV port
- Ergonomical work space
- Makes wiping IV port easy
- Extra set of hands when help not around
- Helps make RSI safe
- Creates valuable space for non-OR anesthesia

Value to Hospital

- Helps with regulatory compliance
- Sharps management
- Could help reduce HAIs
- Demonstrates support for anesthesia team
- Reusable/single fixed cost

1. The recessed tray holds and organizes supplies for induction of anesthesia and most anesthetic procedures
2. Clips keep IV tubing securely in place, so it's easy to "scrub the hub"
3. Corner grips for suction tubing and more
4. The adjustable support post lets you position it just where you need it
5. The anesthesia circuit clips keep your circuit fixed and firmly in place
6. Patented clamp attaches to OR bed, IV pole, or inpatient bed

**Anestand can help health systems save lives,
lower costs and improve compliance.
All at the same time.**

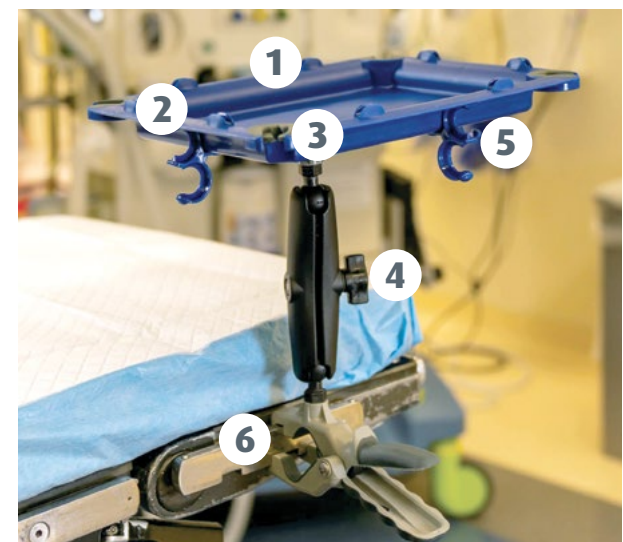
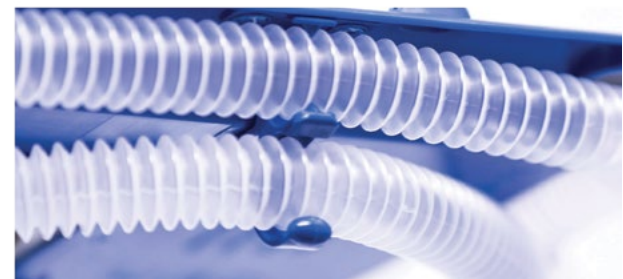



Scan to learn more

The first and only anesthesia stand to safely and securely keep all supplies where they're needed can also be one of your best weapons in combatting infections.

Anestand Facts

- A small investment could help in compliance, save time and quickly pay for itself.
- By having supplies and medications organized and easily available with IV port ready, Anestand aids in patient safety.
- The bottom line: Anestand could help prevent costly infections and save money by helping anesthesia providers save OR time.

Of all the many safety and security features Anestand offers, perhaps the single greatest is how it helps health systems to lower HAIs.

- Having IV port ready for site alcohol scrub makes disinfection (and compliance) easier — Anestand keeps your IV port ready for scrubbing.
- By keeping medications immediately available and infusion ports clearly defined Anestand provides additional safety.
- By keeping supplies immediately available, Anestand helps make RSI (rapid sequence inductions) safe.
- During COVID, Anestand assists anesthesia providers as an extra pair of hands, while other healthcare personnel are being asked to keep distance from the airway.

Anestand can provide value in safety, compliance, and convenience. As soon as you use it, you'll wonder how you ever managed without it.

- CDC, JCAHO, SHEA, and other organizations require cleaning the port with every injection. Anestand helps your facility and providers comply with these regulations.
- Patients with an HAI stay 19 additional days, or \$11.2 million in HAI treatment and/or lost revenue. For a small fixed cost your facility could get a large return on investment.
- Keeping supplies organized on a tray may prevent dropped items and reduce replacement costs. Anestand makes it far easier to keep supplies organized and right at hand.



SUNSET HEALTHCARE SOLUTIONS

Sol Full Face CPAP Mask

Mask with Headgear and Replaceable Cushion



Size	Item#
Small	CM205S
Medium	CM205M
Large	CM205L

Ask us about our 30-day mask guarantee

Replacement Cushions

Size	Item#
Small	CUCM205S
Medium	CUCM205M
Large	CUCM205L

HCPCS#
 MASK - A7030
 HEADGEAR - A7035
 CUSHION - A7031



A premium mask without the premium price

Easy pop cushions

Cushions attach or detach from mask in an easy pop; no need to painstakingly align pieces

Quiet vent

Honeycomb design reduces airflow erosion intensity for gentle and quiet flow

Quick release connector

Rapidly and easily separates or connects mask and the tube

Soft and light headgear

Skin-friendly fabric, light and stable design helps patients comfortably adapt to treatment

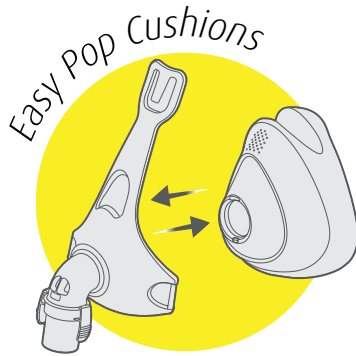

Sol comes in attractive retail packaging



Ray Pediatric CPAP/NIV Masks



Mask with Headgear, Tube, and Replaceable Cushion

Size	Item#
Small	CM061S
Medium	CM061M
Large	CM061L
Extra Large	CM061XL

Replacement Cushions

Size	Item#
Small	CUCM061S
Medium	CUCM061M
Large	CUCM061L
Extra Large	CUCM061XL

HCPCS#
 MASK - A7030
 HEADGEAR - A7035
 CUSHION - A7031



Nasal Mask with Headgear, Tube, and Replaceable Cushions

Comes with	Item#
S&M Cushions	CM060-KITS
L&XL Cushions	CM060-KITL

Replacement Cushions

Size	Item#
Small	CUCM060S
Medium	CUCM060M
Large	CUCM060L
Extra Large	CUCM060XL

HCPCS#
 MASK - A7034
 HEADGEAR - A7035
 CUSHION - A7032



• Comparable to Nonny masks

SUNSET HEALTHCARE SOLUTIONS

Sunset Deluxe Full Face CPAP Masks

Mask with Flex Tube, Headgear, and Replaceable Cushion

Size	Item#
Small	CM005S
Medium	CM005M
Large	CM005L

Unobtrusive design offers a clear line of sight



Mask with Adjustable Forehead T, Headgear, and Replaceable Cushion

Size	Item#
Small	CM105S
Medium	CM105M
Large	CM105L



HG003 Headgear - Fits Most
HG003XL Headgear - XL

CMSIZE01
Deluxe Sizing Guide

HCPCS#
MASK - A7030
HEADGEAR - A7035
CUSHION - A7031

Replacement Cushions

Size	Item#
Small	CUCM005S
Medium	CUCM005M
Large	CUCM005L

Mask without Headgear

Size	Item#
Small	CM005SNH
Medium	CM005MNH
Large	CM005LNH

- 360° dual-swivel elbow port allows for free movement while connected to the tubing
- Quick-release clips make it easy to remove the mask without resetting the headgear
- Ultra-lightweight silicone replaceable cushion increases comfort while maintaining optimal seal

Sunset Deluxe Nasal CPAP Masks

Mask with Headgear and Replaceable Cushion

Size	Item#
Small	CM006S
Medium	CM006M
Large	CM006L

Same features as the full face with 360° dual-swivel elbow port, quick release clips, and ultra-lightweight replaceable cushions.



HG003 Headgear - Fits Most
HG003XL Headgear - XL

CMSIZE01
Deluxe Sizing Guide

HCPCS#
MASK - A7034
HEADGEAR - A7035
CUSHION - A7032

Mask with Headgear, Adjustable Forehead T, and Replaceable Cushion

Size	Item#
Small	CM106S
Medium	CM106M
Large	CM106L



Replacement Cushions

Size	Item#
Small	CUCM006S
Medium	CUCM006M
Large	CUCM006L

Mask without Headgear

Size	Item#
Small	CM006SNH
Medium	CM006MNH
Large	CM006LNH

SUNSET HEALTHCARE SOLUTIONS

Sunset Deluxe Nasal Pillow CPAP Mask

Item#
CM036
 Mask with Headgear and Small, Medium, and Large Pillows

HG036
 Headgear Only

HCPCS#
 MASK - A7034
 HEADGEAR - A7035
 PILLOWS - A7033



Replacement Pillows

Size	Item#
Small	CM036SP
Medium	CM036MP
Large	CM036LP



Mask without Headgear

CM036NH

- Easy to fit, assemble, and maintain
- Three different pillow sizes to fit more people more easily
- 360° rotational elbow with flexible silicone tube
- Quiet vent design

Sunset ClearSight Deluxe Nasal Mask

Mask with Headgear and Replaceable Cushion

Size	Item#
Small	CM110S
Medium	CM110M
Large	CM110L

HG003 Headgear - Fits Most
HG003XL Headgear - XL

Replacement Cushions

Size	Item#
Small	CUCM110S
Medium	CUCM110M
Large	CUCM110L

HCPCS#
 MASK - A7034
 HEADGEAR - A7035



• ClearSight design provides unobstructed view

Mask Series	Mask Type	Replaceable Cushion	Forehead Support	Flex Tube Included	Headgear Included
CM005	Full Face	✓		✓	✓
CM105	Full Face	✓	✓ (Adjustable)		✓
CM006	Nasal	✓	✓	✓	✓
CM106	Nasal	✓	✓ (Adjustable)		✓
CM007	Full Face				✓
CM008	Nasal				✓
CM110	Nasal	✓			✓
CM036	Nasal Pillow	✓		✓	✓

Sunset Classic Full Face CPAP Mask

Mask with Headgear

Size	Item#
Small	CM007S
Medium	CM007M
Large	CM007L
Extra Large	CM007XL

HG003 Headgear - Fits Most
HG003XL Headgear - XL

CMSIZE02 Classic Sizing Guide



HCPCS#
 MASK - A7030
 HEADGEAR - A7035



**1/2 THE WEIGHT
 OF LEADING MASKS**

- Conventional forehead pad removed
- to create a clear line of sight
- Minimalist design and ultra-lightweight silicone
- Quick-release clips make it easy to remove
- 360° dual-swivel elbow port allows for free movement
- One-piece mask and cushion design is durable and easy

Sunset Classic Nasal CPAP Mask

Mask with Headgear

Size	Item#
Medium	CM008M
Large	CM008L

HG003 Headgear - Fits Most
HG003XL Headgear - XL

CMSIZE02 Classic Sizing Guide



HCPCS#
 MASK - A7034
 HEADGEAR - A7035

- Great value for cash patients or those with lower insurance reimbursement
- Headgear clips allow for quick removal of mask — no further adjustments required after initial fitting
- One-piece mask and cushion design is durable and easy

SLEEPNET

Phantom®2 and iQ®2

Phantom®2

Item#
CM050



Replacement Cushion
CUCM050

NEW

iQ®2

Item#
CM049



Replacement Cushion
CUCM049

Replacement Frame/Tubing Assembly
CM051

Ask us about our
30-day mask guarantee

- Sleepnet's patented AIR°gel® technology provides maximum comfort while minimizing skin irritation and pressure points on the nasal bridge. Unlike many other gel masks, the unique qualities of AIR°gel® allow the mask to seal with minimal tension. By design AIR°gel® is twice as soft as competing gel products.
- Sleepnet has the only mask that you can shape to each individual face. Flex, Fit, Forget!
- Cushions may be removed and replaced without purchasing a new mask.
- Magnetic Clips — Easy on and off!
- 360° Swivel — Less tube drag for active sleepers.
- One size cushion — Larger fitting range.



Innova

Nasal Mask with Headgear

Size	Item#
Small/Medium	CM034SM
Medium/Large	CM034ML

HCPCS#
 MASK - A7034
 HEADGEAR - A7035

Full Face Mask with Headgear

Size	Item#
Small	CM035S
Medium	CM035M
Large	CM035L

HCPCS#
 MASK - A7030
 HEADGEAR - A7035



Innova® CPAP masks feature patented AIR^ogel with Advanced Cushion Technology and Active Headgear Connector™. Together, they provide an optimal fit, maximum comfort, and freedom.

- The Touchless Spacebar's unique design eliminates any contact with the patient's forehead
- The quick-release headgear is lightweight, breathable, and slides off easily with one hand
- Made in the USA

MiniMe Pediatric Nasal Mask

Mask with Headgear

Headgear Size	Item#	OEM#
Small	CM004S	60213
Medium	CM004M	60214
Large	CM004L	60215



Replacement Headgear

Size	Item#	OEM#
Small	HG010S	55241
Medium	HG010M	55242
Large	HG010L	55243

HCPCS#
 MASK - A7034
 HEADGEAR - A7035

- Non-vented version available

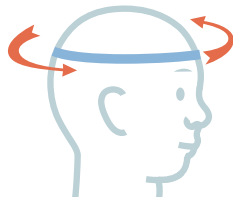

MASK SIZE	HEAD CIRCUMFERENCE
SMALL	14-16in
MEDIUM	17-18in
LARGE	19-21in

Measure around head above eyebrows for head circumference

MiniMe 2 Pediatric Nasal Mask

Mask with Headgear

Size	Item#	OEM#
Extra Small	CM027XS	60216
Small	CM027S	60217
Medium	CM027M	60218
Large	CM027L	60221



Replacement Headgear

Size	Item#
Extra Small/Small	HG027S
Medium/Large	HG027L

HCPCS#
 MASK - A7034
 HEADGEAR - A7035

- Non-vented version available



Ascend

Nasal Mask with Headgear and All Cushions

Item# **CM037N**

Replacement Cushions

Size	Item#
Small	CM037NCS
Medium	CM037NCM
Large	CM037NCL

Nasal Mask with Headgear and 1 Cushion

Size	Item#
Small	CM037NS
Medium	CM037NM
Large	CM037NL

HCPCS#
MASK - A7034
HEADGEAR - A7035
CUSHION - A7032

Full Face Mask with Headgear and All Cushions

Item# **CM037F**

Replacement Cushions

Size	Item#
Small	CM037CS
Medium	CM037CM
Large	CM037CL

Full Face Mask with Headgear and 1 Cushion

Size	Item#
Small	CM037S
Medium	CM037M
Large	CM037L

HCPCS#
MASK - A7030
HEADGEAR - A7035
CUSHION - A7031

- One frame with three sizes of replaceable cushions: S, M, L
- Unique flexible spacebar provides superior stability, holding a seal without contacting the skin
- Sleepnet's patented AIR^ogel minimizes pressure points and skin irritation while offering maximum comfort with minimum weight
- Lightweight, breathable quick-release headgear slides off easily with one hand
- 360-degree rotating elbow for optimal tube positioning and easier mobility
- Active Headgear Connector moves as the patient moves for a reliable seal
- Made in the USA

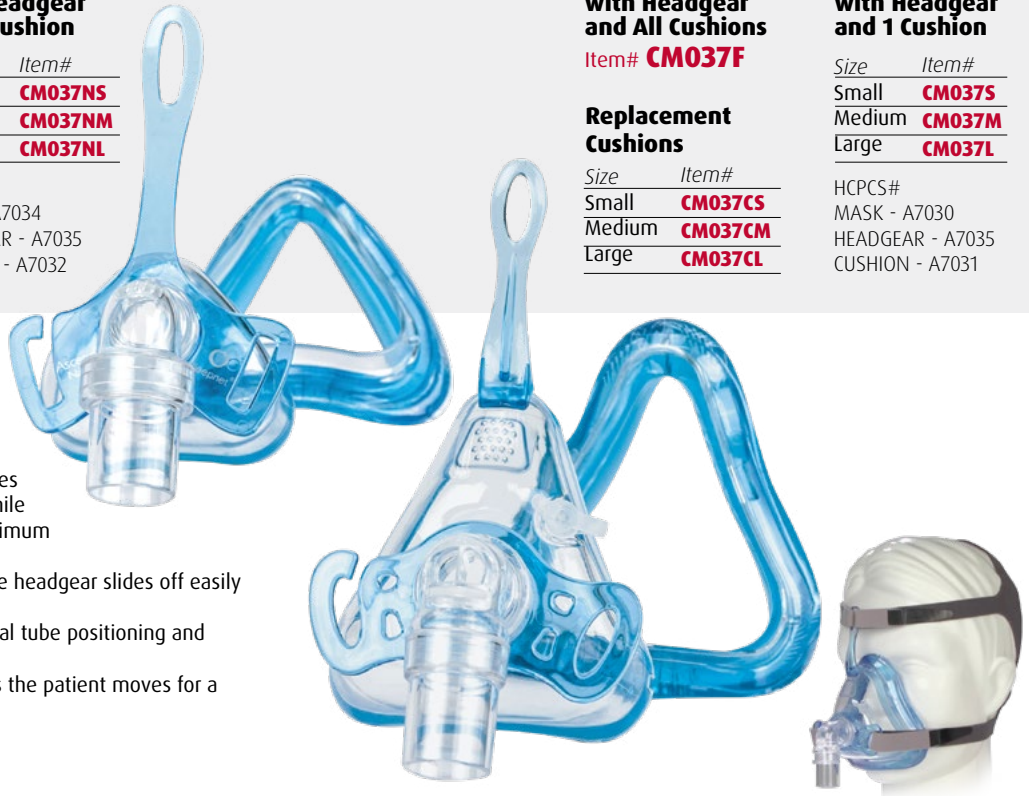

iQ Nasal Mask

Item# **CM001**

iQ Nasal Mask with Headgear
OEM# TMS-889

HCPCS#
MASK - A7034
HEADGEAR - A7035

HG005

3-Point Headgear Only
OEM# TMS-89-55046

HG009

Holey Cap Style Headgear Only



Mojo 2 Full Face Mask

Mask with Headgear

Size	Item#	OEM#
Small	CM50817	50817
Medium	CM50818	50818
Large	CM50819	50819
Extra Large	CM50820	50820

- Maximum comfort, minimum weight. Patented AIR^ogel minimizes pressure points and skin irritation.
- Forehead adjustment screw removes pressure from the bridge of the nose for personalized fit.
- The shapeable shell of each mask can be easily molded to fit individual needs. Bend it. Mold it. Shape it.
- Lightweight, breathable headgear disconnects from mask easily with one hand thanks to the quick-release magnetic headgear clips.
- Oxygen port allows easy delivery of supplemental oxygen.
- 360° rotating elbow for optimal tube positioning and easier mobility.



Mojo Full Face Mask

Mask with Headgear

Size	Item#	OEM#
Small	CM003SH	TMS-835
Medium	CM003MH	TMS-836
Large	CM003LH	TMS-837

Replacement Headgear

HG003
OEM# TMS-89

HCPCS#
MASK - A7030
HEADGEAR - A7035



Visit www.sunsethcs.com/acuteacare

CIRCADIANCE

SleepWeaver® Advance Nasal Mask



Blue

- One size fits most (Small Tan available for smaller faces)
- Includes Advance headgear that can be adjusted to fit a broader range of patients



Leopard



Camo



Pink



Tan

Mask with Adjustable Headgear

Mask Color	Item#	OEM#
Blue	CM017B	100274
Camo	CM017C	100281
Leopard	CM017L	100285
Pink	CM017P	100277
Tan	CM017T	100332

CM017T-S
Small Tan
OEM# 101224

HCPCS#
MASK - A7034
HEADGEAR - A7035

HG017
Headgear Only
OEM# 100435

CM017TNH
Tan — No Headgear
OEM# 100336

- Easy to store and pack for travel

SleepWeaver® Élan Nasal Mask

Mask Kit

Mask Color	Item#	OEM#
Tan	CM022T-KIT	100563
Blue	CM022B-KIT	100782

Kits Include:

- Mask
- Small Cushion
- Regular Cushion
- Large Cushion
- Headgear
- Feather Weight Tube®
- Overhead Tube Tether Strap
- Quick Start Illustration Guide
- Instructional DVD

HCPCS#
MASK - A7034
HEADGEAR - A7035
TUBE - A7037

TUB0018F
Replacement
Feather Weight Tube®
OEM# 100477

HG022
Headgear Only
OEM# 100630

Mask with Headgear only

Size and Color	Item#	OEM#
Small Blue	CM022B-S	100728
Regular Blue	CM022B-R	100519
Large Blue	CM022B-L	100482
Small Tan	CM022T-S	100727
Regular Tan	CM022T-R	100518
Large Tan	CM022T-L	100481

All SleepWeaver Masks

- Made of soft cloth
- Allow sleeping on side, stomach, and even wearing glasses
- Easy to store and pack for travel
- Hand or machine washable gentle cycle, mild detergent, hang to dry

Replacement Cushions

Size and Color	Item#	OEM#
Small Blue	CUCM022B-S	100743
Regular Blue	CUCM022B-R	100654
Large Blue	CUCM022B-L	100664
Small Tan	CUCM022T-S	100742
Regular Tan	CUCM022T-R	100653
Large Tan	CUCM022T-L	100663
Small Leopard	CUCM022L-S	100746
Reg. Leopard	CUCM022L-R	100657
Large Leopard	CUCM022L-L	100667



- Detachable 90° elbow with 360° rotation allows for over-the-head hose placement

SleepWeaver® Anew™ Full Face Mask

Blue Mask with Headgear

Size	Item#	OEM#
Small	CM026B-S	100955
Regular	CM026B-R	100960
Large	CM026B-L	100965

Headgear

Size	Item#	OEM#
Small	HGCM026-S	101145
Reg/Lg	HGCM026-R	101084

TUB0018F

Feather Weight Tube®
OEM# 100477

HCPCS#
MASK - A7027
HEADGEAR - A7035
TUBE - A7037



- Soft material wicks away moisture and leaves no pressure marks on the face
- Loose fit provides ultimate comfort and eliminates strap marks
- Open line of sight accommodates eyeglasses and is great for people who like to fall asleep while reading or watching TV
- 90° elbow swivel connector rotates 360° allowing users to sleep in more natural positions; easy to remove and clean

Pediatric SleepWeaver® CPAP Mask

Item#
CM101325

- Same proven cloth technology enhanced to accommodate children 2 through 7 years of age

The launch of the SleepWeaver Advance Pediatric Soft Cloth CPAP Mask marks the development of a revolutionary interface for CPAP use in pediatric patients. This new configuration extends the range of SleepWeaver products to include pediatric users with delicate facial features.



SleepWeaver® 3D®

Item#
CM027

NEW

Blue Mask with Headgear

Headgear	Item#
With Large Headgear	CM027-LB
With Regular Headgear	CM027-RB
Nasal Mask (no headgear)	CM027

100/packs

Headgear	Item#
With Large Headgear	CM027-L-100
With Regular Headgear	CM027-R-100



- New wing-shaped stay routes the headgear under the ears, ensuring comfort and a great fit.
- Permanent 360° swivel provides reliable performance in any position, including over the headboard.
- Breathable cloth design eliminates fogging that is common in hard plastic masks. Nothing breathes like cloth, keeping skin dry and comfortable.
- For those who want to read or watch TV while in bed, SleepWeaver 3D can be worn with glasses.
- Users prefer a soft cloth against the face over rubber, silicone and other gels. Cloth masks eliminate the need for a cushion or nasal pad.

Aloha® Nasal Pillows System

Item#
CM014

All Sizes Kit
OEM# ALO100

Replacement Headgear

HG014
Aloha Headgear
OEM# ALO130

Replacement Pillows

Size	Item#	OEM#
Small	CM014SP	ALO121
Medium	CM014MP	ALO123
Large	CM014LP	ALO125



Frame

Size	Item#	OEM#
Small	CM014FS	ALO131
Medium	CM014FM	ALO133
Large	CM014FL	ALO135

HCPCS#
MASK - A7034
HEADGEAR - A7035
PILLOWS - A7033

- One of the highest consumer-rated CPAP masks on the market
- Limited headgear reduces points of contact on the face and prevents interference with the eyes
- Removable micro-fleece headgear wraps are included for comfort
- Pillow angle can be adjusted for a more customized and natural fit

AIRWAY MANAGEMENT

Tap Pap

No headgear needed!

Item#
CM024NH

Mask Kit with Small, Medium, and Large Pillows
OEM# PAP-NP1-000

Replacement Pillows

Size	Item#	OEM#
Small	CUCM024S	PAP-NP1-101
Medium	CUCM024M	PAP-NP1-102
Large	CUCM024L	PAP-NP1-103

HG024
Tap Pap Headgear
OEM# PAP-NP1-300

CM024MP
Replacement Mouthpiece
OEM# PAP-NP1-201

HCPCS#
MASK - A7034
PILLOWS - A7033
HEADGEAR - A7035



- Mouthpiece molds to the upper teeth to provide a custom and secure fit even if the bottom teeth are not in contact with the mouthpiece
- Unique nut and bolt joint allows the nasal pillows to be set to the desired angle
- Provides a stable fit regardless of the sleep position
- Patients report not being able to feel the mask on their face
- 3 sizes of nasal pillows included (Small, Medium, and Large)
- 90-day compliance guarantee for new users of the mask, 30-day guarantee for experienced users

AIRWAY MANAGEMENT

myTAP



Item# **CM039**

Precision-fit, immediate, simple and affordable solution for snoring and mild to moderate sleep apnea.

NEW

- Offers immediate treatment
- Can be fitted in 15 minutes in a sleep lab, physician's office or HME
- Clinically proven in over 40 independent peer reviewed studies to treat snoring and obstructive sleep apnea (OSA).
- Patients control and remold trays with Precision-Fit, enabling overall comfort, compliance and success. 90% of patients achieve ideal fit upon first try. No bite registration needed.
- Thin, sleek trays create a comfortable, low-profile appliance
- Simple design makes it an affordable and convenient option
- Includes an AM Aligner to help offset potential bite changes
- Includes a mouth shield accessory to prevent dry mouth or excess saliva. A secondary benefit is the promotion of nasal breathing, the best natural way to breathe.

AIRAVANT

Bongo Rx EPAP

Item# **CAPBNG500**

Bongo Rx all sizes starter kit

- All four sizes: small, medium, large, and extra large
- Travel case
- Drying stand
- Headgear

NEW



Annual Replenishment Pack

Includes 4 pairs, travel case, drying stand, and headgear

Size	Item#
Small	CAPBNG502
Medium	CAPBNG503
Large	CAPBNG504
Extra Large	CAPBNG505



The Bongo Rx is a simple device with soft nasal seals and is available in various sizes (S, M, L, and XL). The Bongo Rx is an EPAP (expiratory positive airway pressure) device and works as follows:

- During inhalation, small valves open to allow normal breathing through the device.
- During exhalation, the valves close and direct exhaled air through small vents to generate EPAP, which keeps the airway open.

- No machine, tube, electricity, or batteries needed
- Use at home, traveling, camping... use anytime, anywhere
- Small enough to fit in a shirt pocket
- Reusable and easy to clean with simply soap and water
- Designed, molded, and assembled in the USA
- Clinically tested to demonstrate safety and effectiveness
- Supplemental lifestyle option for your compliant patients
- Patient friendly option for your non-compliant patients

CPAP TUBING

Durable CPAP Tubing — Gray



Item#
TUB06
6ft
19mm with 22mm cuffs

HCPCS# A7037

- Sunset's most popular item
- Compatible with nearly all CPAP, BiPAP and BiLevel systems for every manufacturer on the market
- Smooth interior and a corrugated exterior for excellent flexibility and unrestricted interior flow characteristics
- Injection molded cuffs to reduce tearing
- Low memory to avoid kinks
- BPA-free and latex-free

All Lengths

TUB0018	18in
TUB002	2ft
TUB004	4ft
TUB06	6ft
TUB06.5	6ft 6in — Compatible with ResMed tube wraps
TUB007	7ft
TUB008	8ft
TUB009	9ft
TUB010	10ft

Compatible with Sunset's new quick release connector!

Item#
CAP1016

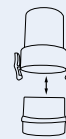

Slim CPAP Tube

Item#
TUB006SS
6ft x 15mm with
22mm cuffs
HCPCS# A7037



- Highly durable**
Strain relief cuff decreases separation and tearing
- Virtually no memory**
Designed to be the most flexible tube available
- Minimal weight**
One of the lightest tubes on the market at 2.6 ounces
- Great value**
Affordable and sustainable

Pressure Port Tubing

Item# **TUB006PP**
6ft with Pressure Sensor Lines
22mm Cuffs • HCPCS# A7037

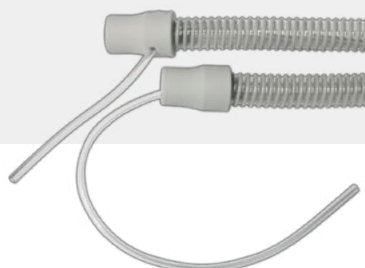

- Built-in sensor line for use with the Puritan Bennett: GoodKnight 420S, 420E and 425 and KnightStar 330

HEATED CPAP TUBING

Heated Tube for Respironics

Item#

TUB06HPR

Heated Tube for
Philips Respironics
Dreamstation Series
and System One

OEM# HT15
HCPCS# A4604

- 510(k)
- UL Recognized
- Strain relief cuffs
- Auto safety shut-off

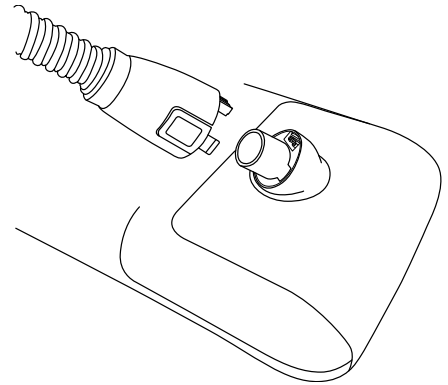

TUBHC900ICON208

Heated Tube for Fisher & Paykel ICON

OEM# 900ICON208

Hybernite Heated CPAP Tube 6ft

Item#

TUB006ROC

MOQ may apply

NEW

- Copper wire embedded in the tubing wall generates uniform heat and maintains the air temperature inside the tube to prevent rainout.
- Stand-alone kit can be used in the sleep lab or at home with any CPAP or BiPAP machine with humidifier.
- Includes heated circuit tube and independent power supply.

Compatible with machines that use standard CPAP Tubing.
Not compatible with machines that use slim 15mm tubing
such as newer Respironics and ResMed machines.



TUB006HBT

Hybernite Replacement Heated CPAP Tube 6ft

DreamStation 2

NEW



Item# **CF1012**
Disposable Filter
6/pack
OEM# 1142831
HCPCS# A7038
CF1012-1 1/pack
CF1012-2 2/pack
CF1012-3 3/pack
CF1012-50 50/pack

Item# **CF1012F**
Reusable Filter
2/pack
OEM# 1142687
HCPCS# A7039
CF1012F-1 1/pack

DreamStation



Item# **CF1010**
Disposable Filter
6/pack
OEM# 1122519
HCPCS# A7038
CF1010-1 1/pack
CF1010-2 2/pack

Item# **CF1010F**
Reusable Filter
2/pack
OEM# 112446 (1-pack)
HCPCS# A7039
CF1010F-1 1/pack
CF1010F-6 6/pack

DreamStation Go Filters



Item# **CF101130D**
30-Day Disposable Filter
6/pack
OEM# 1133744
HCPCS# A7038

Item# **CF101190D**
90-Day Reusable Filter
2/pack
OEM# 1133743
HCPCS# A7039

PR System One



Item# **CF1009NT**
Ultrafine Filter - No Tab
6/pack • 1^{3/4}" x 7/8"
OEM# 1029331
HCPCS# A7038
CF1009NT-1 1/pack
CF1009NT-2 2/pack

Item# **CF1009**
Ultrafine Filter - Tabbed
6/pack • 1^{3/4}" x 7/8"
HCPCS# A7038
CF1009-1 1/pack
CF1009-2 2/pack

M-Series



Item# **CF1007**
Ultrafine Filter - Tabbed
6/pack • 1^{3/4}" x 7/8"
HCPCS# A7038
CF1007-1 1/pack
CF1007-2 2/pack

Item# **CF1007F**
Foam Filter
2/pack • 1^{5/8}" x 7/8"
HCPCS# A7039
CF1007F-1 1/pack

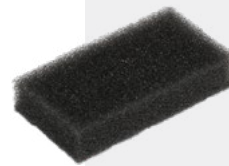

Item# **CF1009F**
Foam Filter
2/pack • 1^{5/8}" x 7/8"
OEM# 1029330
HCPCS# A7039
CF1009F-1 1/pack

RESPIRONICS

REMstar Pro, REMstar Plus



Item# **CF1006**
 Ultrafine Filter
2/pack • 3¹/₂" x 1¹/₂"
 OEM# 1005945
 HCPCS# A7038

Item# **CF1006F**
 Foam Filter
2/pack • 3⁵/₈" x 1⁵/₈"
 OEM# 1005964
 HCPCS# A7039

BiPAP Pro, Plus, Duet LX, Synchrony



Item# **CF1005**
 Ultrafine Filter
6/pack • 4³/₄" x 3¹/₄"
 OEM# 622219
 HCPCS# A7038

Item# **CF1005F**
 Foam Filter
2/pack • 4³/₄" x 2³/₈"
 OEM# 622220
 HCPCS# A7039

Aria, Virtuoso, Duet, Quartet



Item# **CF1004**
 Ultrafine Filter
6/pack • 3¹/₂" x 2³/₁₆"
 OEM# 532311
 HCPCS# A7038

Item# **CF1004F**
 Foam Filter
2/pack • 3¹/₄" x 2¹/₈"
 OEM# 532247
 HCPCS# A7039

REMstar



Item# **CF1003**
 Ultrafine Filter
6/pack • 5¹/₂" x 4³/₄"
 OEM# 362522
 HCPCS# A7038

Item# **CF1003F**
 Foam Filter
1/pack • 5³/₄" x 5¹/₄"
 OEM# 362521
 HCPCS# A7039

Solo, Aria LX, Virtuoso LX, REMstar LX

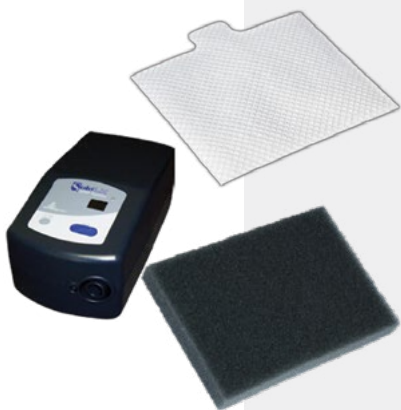

Item# **CF1002**
 Ultrafine Filter
6/pack • 3³/₈" x 2³/₄"
 OEM# 622017
 HCPCS# A7038

Item# **CF1002F**
 Foam Filter
2/pack • 3⁵/₁₆" x 2⁵/₁₆"
 OEM# 622018
 HCPCS# A7039

SleepEasy/BiPAP



Item# **CF1001**
 Ultrafine Filter
6/pack • 7³/₄" x 4⁷/₈"
 OEM# 302064
 HCPCS# A7038

*All filters can be ordered in any pack quantity.
 Contact your sales rep for details.*

AirSense 11



Item# **CF2111**
 Disposable Filter
3/pack
 HCPCS# A7038
CF2111-1 1/pack OEM# 39300
CF2111-2 2/pack



Item# **CF2111HA-3**
 Hypoallergenic Filter
3/pack
 1 1/4" x 1 3/16"
 HCPCS# A7038
CF2111HA-1 1/pack
CF2111HA-2 2/pack

S9 and AirSense 10 Series



Item# **CF2107**
 Disposable Filter
3/pack • 2 1/8" x 1 3/8"
 HCPCS# A7038

CF2107-1 1/pack OEM# 36850
CF2107-2 2/pack OEM# 36851
CF2107-50 50/pack OEM# 36853



Item# **TUB06S9COMBO**
 S9 Filter and CPAP Tube Kit
 6 - CF2107
 1 - 6ft CPAP Tube

KIT

AirMini



Item# **CF2108**
 Disposable Filter
2/pack • 1 1/4" x 1 3/16"
 OEM# 38815
 HCPCS# A7038



Item# **CF2107HA**
 Hypoallergenic Filter
3/pack • 2 1/8" x 1 3/8"
 HCPCS# A7038

CF2107HA-1 1/pack OEM# 36855
CF2107HA-2 2/pack OEM# 36856
CF2107HA-50 50/pack
 OEM# 36858

Adapt SV



Item# **CF2106**
 Disposable Filter
3/pack • 1 1/4" x 1 1/2"
 OEM# 26926
 HCPCS# A7038
CF2106-50 50/pack

Item# **CF2106HA**
 Hypoallergenic Filter
3/pack • 1 1/4" x 1 1/2"
 OEM# 26927
 HCPCS# A7038
CF2106HA-50 50/pack

Auto Set T



Item# **CF2104**
 Disposable Filter
3/pack • 4 1/4" x 3 1/4"
 OEM# 17937
 HCPCS# A7038

CF2104-50 50/pack OEM# 17938

S8 Series

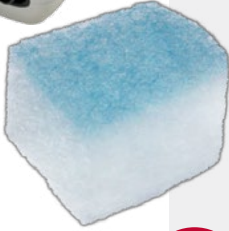

Item#
CF2105
Disposable Filter
3/pack • 1³/₈" x 1³/₈"
OEM# 33916
HCPCS# A7038

CF2105-1 1/pack OEM# 33915
CF2105-2 2/pack OEM# 33973
CF2105-50 50/pack OEM# 33918



Item#
TUB06S8COMBO
S8 Filter and CPAP Tube Kit
6 - CF2105
1 - 6ft CPAP Tube



Item#
CF2105HA
Hypoallergenic Filter
3/pack • 1³/₈" x 1³/₈"
OEM# 33920
HCPCS# A7038

CF2105HA-1 1/pack OEM# 33919
CF2105HA-2 2/pack OEM# 33975
CF2105HA-50 50/pack OEM# 33922

S7 Series



Item#
CF2103
Disposable Filter
3/pack • 1¹/₄" x 1¹/₂"
OEM# 30907
HCPCS# A7038

CF2103-1 1/pack OEM# 30919
CF2103-2 2/pack
CF2103-50 50/pack OEM# 30908



Item#
CF2103HA
Hypoallergenic Filter
3/pack • 1¹/₄" x 1¹/₂"
HCPCS# A7038

CF2103HA-1 1/pack OEM# 30933
CF2103HA-50 50/pack

S6 Series



Item#
CF2102
Disposable Filter
3/pack • 5³/₄" x 5⁵/₈"
OEM# 21935
HCPCS# A7038

CF2102-50 50/pack
OEM# 21936

FISHER & PAYKEL

SleepStyle Series



Item#
CF4004-2
Disposable Filter
2/pack
HCPCS# A7038

ICON Series



Item#
CF4003
Disposable Filter
4/pack
2 1/16" x 5/8"
HCPCS# A7038

CF4003-1 1/pack
OEM# 900ICON503

CF4003-6 6/pack
OEM# 900ICON212

HC230 Series, HC600 Series

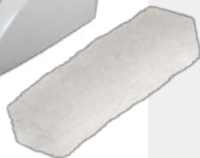

Item#
CF4002
Disposable Filter
4/pack • 2 3/4" x 7/8"
OEM# 900HC240
HCPCS# A7038
CF4002-2 2/pack

HC200, HC220, HC221



Item#
CF4001
Disposable Filter
4/pack • 5" x 3/4"
OEM# 900HC222
HCPCS# A7038
CF4001-2 2/pack

3B

Luna G3



Item# **CF8006-6**
Disposable Filter
6/pack
HCPCS# A7038
CF8006-1 1/pack
CF8006-2 2/pack

Item# **CF8006F-1**
Reusable Filter
1/pack
HCPCS# A7039

Luna and Luna II



Item#
CF8005
Disposable Filter
12/pack • 2" x 1 3/16"
HCPCS# A7038

Item#
CF8005F-1
Reusable Filter
1/pack • 2" x 1 3/16"
HCPCS# A7039
CF8005F-2 2/pack

RESmart

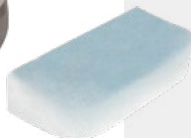

Item#
CF8004
Disposable Filter
3/pack • 3 5/16" x 1 5/8"
HCPCS# A7038

AEIOMED

Everest Aura, Everest III and Integrated

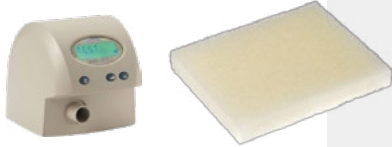

Item# **CF8001**
Foam Filter
2/pack • 2" x 1⁹/₁₆"
OEM# 100446
HCPCS# A7039

BEYOND

ResPlus



NEW
Item# **CF9005F-2**
Reusable Filter
2/pack
HCPCS# A7039
CF9005F-1 1/pack

BREAS/GE

iSleep 20 Series



Item# **CF7003**
Ultrafine Filter
2/pack • 2¹/₄" x 7⁷/₈"
OEM# 004153
HCPCS# A7038

Item# **CF7003F**
Foam Filter
Each • 2³/₄" x 1"
OEM# 004154
HCPCS# A7039

PV10



Item# **CF7002**
Ultrafine Filter
2/pack • 2³/₄" x 7⁷/₈"
OEM# 2B01975
HCPCS# A7038

Item# **CF7002F**
Foam Filter
Each • 2⁵/₈" x 7⁷/₈"
OEM# 2B01972
HCPCS# A7039

PV1

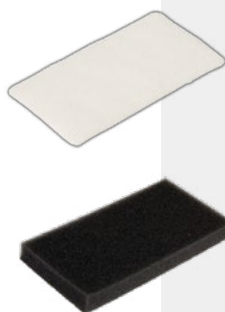

Item# **CF7001**
Ultrafine Filter
2/pack • 2¹/₂" x 1¹/₄"
HCPCS# A7038

Item# **CF7001F**
Foam Filter
3/pack • 2¹/₂" x 1¹/₄"
HCPCS# A7039

CAREFUSION/VIASYS

PureSom



Item#
CF9003
Ultrafine Filter
3/pack • 1³/₁₆" x 1⁷/₁₆"
OEM# 7511
HCPCS# A7038

Item#
CF9003F
Foam Filter
3/pack • 1³/₁₆" x 1⁷/₁₆"
OEM# 7510
HCPCS# A7039

Orion and Pegasus



Item#
CF8002
Ultrafine Filter
6/pack • 2⁷/₈" x 1³/₄"
OEM# 774688
HCPCS# A7038

Item#
CF8002F
Foam Filter
Each • 2⁷/₈" x 1³/₄"
OEM# 774689
HCPCS# A7039

COVIDIEN NELLCOR PURITAN BENNETT

GoodKnight 314/318



Item#
CF6005
Ultrafine Filter
2/pack • 6¹/₈" x 9⁹/₁₆"
OEM# S-126924-00
HCPCS# A7038

Item#
CF6005F
Foam Filter
2/pack • 6¹/₄" x 1"
OEM# S-290609-00
HCPCS# A7039

GoodKnight 420/425



Item#
CF6003
Ultrafine Filter
2/pack • 1³/₁₆" x 3³/₁₆"
OEM# M-413950-04
HCPCS# A7038

Item#
CF6003F
Foam Filter
Each • 1³/₁₆" x 3³/₁₆"
OEM# M-413950-02
HCPCS# A7039

GoodKnight 418 A/G/P/S



Item#
CF6002
Ultrafine Filter
4/pack • 5³/₁₆" x 3³/₄"
OEM# Y-413560-01
HCPCS# A7038

Item#
CF6002F
Foam Filter
6/pack • 5¹/₄" x 3³/₄"
OEM# Y-413560-02
HCPCS# A7039

GoodKnight 418



Item#
CF6001
Ultrafine Filter
4/pack • 2¹/₄" x 1²/₅"
OEM# S-645030-00
HCPCS# A7038

Item#
CF6001F
Foam Filter
6/pack • 2⁷/₁₆" x 1¹/₂"
OEM# S-645029-00
HCPCS# A7039

DEVILBISS

IntelliPAP



Item#
CF5004
Ultrafine Filter
4/pack • 1³/₄" x 1¹/₄"
OEM# DV51D-603
HCPCS# A7038

Item#
CF5004F
Foam Filter
4/pack • 1⁵/₈" x 1³/₁₆"
OEM# DV51D-602
HCPCS# A7039

Horizon LT



Item#
CF5003
Ultrafine Filter
4/pack • 4¹/₄" x 1⁵/₁₆"
OEM# 8000D-603
HCPCS# A7038

Item#
CF5003F
Foam Filter
4/pack • 4¹/₄" x 1⁵/₁₆"
OEM# 8000D-602
HCPCS# A7039

EVO MEDICAL

RemRest



Item#
CF8003F
Foam Filter
3/pack • 2³/₁₆" x 1¹/₁₆"
OEM# 21117
HCPCS# A7039

Comfort PAP



Item#
CF9003
Ultrafine Filter
3/pack • 1³/₁₆" x 1⁷/₁₆"
OEM# 7511
HCPCS# A7038

Item#
CF9003F
Foam Filter
3/pack • 1³/₈" x 1¹/₄"
OEM# 7510
HCPCS# A7039

Enhance your branding!

FREE PRIVATE LABELING

Sunset's free service allows you to put your logo and contact information on our products.

Increase brand awareness and allow patients to easily contact you.

Work with our marketing team to customize the layout with your logo, phone number, website address, and reorder information.

Available on all CPAP tubes and filters.
Minimum orders apply.
Contact your sales rep for details.



HEALTHDYNE

Quest



Item# **CF3003**
Ultrafine Filter
with Curves
5/pack • 4 1/2" x 4 3/8"
OEM# 7302
HCPCS# A7038

Item# **CF3003F**
Foam Filter
with Curves
5/pack • 4 1/2" x 4 1/4"
OEM# 7070
HCPCS# A7039

Tranquility MPR



Item# **CF3002**
Ultrafine Filter
Rectangle/Curve
5/pack • 4 5/16" x 1 7/8"
OEM# 7270
HCPCS# A7038

Item# **CF3002F**
Foam Filter
5/pack
5" x 2 1/4" x 2 1/8"
OEM# 7301
HCPCS# A7039

Tranquility



Item# **CF3001**
Ultrafine Filter
5/pack • 5 1/8" x 1 7/8"
OEM# 7170
HCPCS# A7038

RESVENT

iBreeze



HCPCS# A7038

Ultrafine Filter
CF9901-1 1/pack
CF9901-2 2/pack
CF9901-6 6/pack
CF9901-50 50/pack

INVACARE

Polaris LT



Item# **CF9002**
Ultrafine Filter
3/pack • 5" x 2"
OEM# 1082428
HCPCS# A7038

Item# **CF9002F**
Foam Filter
3/pack • 5" x 2"
OEM# 1082995
HCPCS# A7039

Polaris EX



Item# **CF9001**
Ultrafine Filter
3/pack • 2 3/16" x 1"
HCPCS# A7038

Item# **CF9001F**
Foam Filter
3/pack • 2 1/4" x 1 1/16"
OEM# 1124211
HCPCS# A7039

Polaris TR

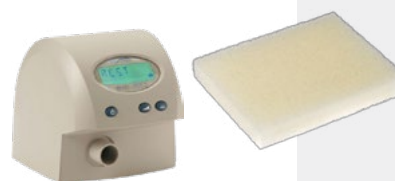

Item# **CF8001**
Foam Filter
2/pack • 2" x 1 9/16"
OEM# 100446
HCPCS# A7039

PROBASICS

Zzz-PAP



Item# **CF9003**
Ultrafine Filter
3/pack • 1 3/16" x 1 7/16"
OEM# 7511
HCPCS# A7038

Item# **CF9003F**
Foam Filter
3/pack • 1 3/16" x 1 7/16"
OEM# 7510
HCPCS# A7039

FISHER & PAYKEL

Humidifier Chamber for ICON Series



Item# **HUMHC900ICON200**

Replacement Chamber for the Fisher & Paykel ICON Series

Each OEM# 900ICON200 • HCPCS# A7046

Compatible with: • ICON Premo
• ICON Novo
• ICON Auto



Humidifier Chambers for HC200 Series



Item# **HUMHC355**

Extended Life Humidifier Chamber for the Fisher & Paykel HC200 Series

Each OEM# HC 355



Item# **HUMHC385**

Replacement Chamber for the Fisher & Paykel SleepStyle HC200 Series

Each OEM# HC 385S

HCPCS# A7046



Compatible with: • HC200 • HC231 • HC236
with: • HC201 • HC232 • HC238
• HC220 • HC233 • HC242
• HC221 • HC234 • HC244
• HC254

Humidifier Chambers for HC100 Series



Item# **HUMHC300**

Extended Life Humidifier Chamber for the Fisher & Paykel HC100 Series

Each OEM# HC 300



Item# **HUMHC325S**

Replacement Chamber for the Fisher & Paykel HC100 Series

Each OEM# HC 325S

HCPCS# A7046

Compatible with: • HC100
• HC105
• HC150



Humidifier Chamber for HC600 Series



Item# **HUMHC365**

Replacement Chamber for the Fisher & Paykel SleepStyle 600 Series

Each OEM# HC 365S • HCPCS# A7046

Compatible with: • HC604
• HC608



RESPIRONICS

Humidifier Chamber for PR System One



Item# **HUM1136502**

Humidifier Chamber for PR System One 60 Series

Each HCPCS# A7046

Humidifier Chamber for DreamStation



Item# **HUM1122520**

Humidifier Chamber for DreamStation

Each HCPCS# A7046



DEVILBISS

Humidifier Chamber for IntelliPAP



Item# **HUMDV5C**

Humidifier Chamber for DeVilbiss IntelliPAP Series

Each HCPCS# A7046

SUNSET CHINSTRAPS

All chinstraps are latex-free • Hand wash only • Lay flat to dry

Universal Neoprene Chinstrap



Item# **CS001**
 Universal Chinstrap
 HCPCS# A7036

- One size fits most
- Attaches to itself at the top of the head
- Can be used with any nasal mask or pillows

Basic Chinstrap



Item# **CS002**
 Compare to
 Respirationics Basic
 OEM# 302175
 HCPCS# A7036

- One size fits most
- Attaches to the top strap of headgear
- Cups the chin for comfort
- Works best with any nasal mask

Adjustable Neoprene Chinstrap



Size	Item#
6in	CS003S
7in	CS003R
8in	CS003M
9in	CS003L
10in	CS003XL

Compare to Puresom Ad-justable Ruby
 OEM# TMS-09 ADJ
 HCPCS# A7036

- Thin adjustable strap attaches at the top of the head. Thicker bottom strap attaches to itself at the back of the head.
- Great for hard-to-fit patients

For fitting, measure along one side of the head, as indicated by the dashed line above.

Deluxe Chinstrap



Size	Item#
26in	CS004S
28in	CS004L

Compare to
 Respirationics Deluxe
 OEM# 302425
 HCPCS# A7036

- Attaches to itself at the top of the head, two smaller support straps keep the system in place
- Extra-wide strap distributes pressure to add comfort

Comfort Chinstrap



Item# **CS005**
 Compare to
 ResMed Sullivan
 OEM# 16015
 HCPCS# A7036

- One size fits most
- Easy to use —Attaches to itself at the top of the head
- Soft cloth chin cup adds comfort

Premium Chinstrap



Item# **CS006**
 Compare to
 Respirationics Premium
 OEM# 1012911
 HCPCS# A7036

- One size fits most
- Attaches to itself at the top of the head to keep the chin lifted. Smaller support strap attaches to a split section of the chinstrap and wraps around the head for added stability.

SUNSET CHINSTRAPS AND HEADGEAR

All chinstraps and headgear are latex-free • Hand wash only • Lay flat to dry

Ruby Style Chinstrap

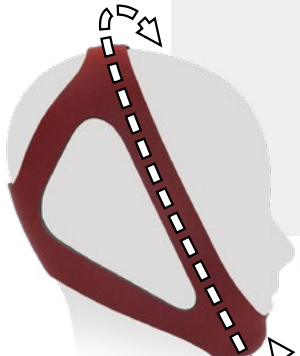

For fitting, measure completely around the head, as indicated by the dashed line above.

Size	Item#
21.5-22.5in	CS007S
22-23in	CS007M
23-24in	CS007L

Compare to Puresom Ruby
OEM# TMS-09 • HCPCS# A7036

- One piece stretches to slide over the top of the head — no need to Velcro
- Can be used with any nasal mask or pillows

Halo Style Chinstrap



Item# **CS025**
Compare to BreatheWear Halo Chinstrap
OEM# H3407
HCPCS# A7036

Ruby Style Adjustable Chinstrap



Size	Item#
Regular	CS007-ADJ
Extra Large	CS007-ADJXL

HCPCS# A7036

- Fully adjustable
- Super soft materials for extra comfort



Universal Mesh Headgear



Item# **HG001**
Compare to Respironics SimpleStrap Headgear
OEM# 302328
HCPCS# A7035

- One size fits most
- Can be used with most 4-point nasal or full face masks

Universal Headgear



Size	Length	Item#
Regular	22.5in	HG003
Extra Large	24.5in	HG003XL

HCPCS# A7035

- Can be used with most 4-point nasal or full face masks

CLEANERS AND ACCESSORIES

Sunset Cleaning Wipes — Flowpack

Item#
CAP1003S

12/case
Flowpack of 64 wipes

CAP1003S-80

12/case
Flowpack of 80 wipes

- Ingredients are safe and gentle for daily cleaning of all types of CPAP and oxygen masks and equipment



Private Label CPAP Wipes

Order the flowpack wipes with your logo and contact info on a lid sticker, with a minimum quantity commitment. Talk to your sales rep for more info.



Citrus II Cleaning Wipes

Item# **CAP1003**
Canister of 62 wipes
12/case



Cleaning Wipes — Single Packs

CAP1005
Citrus II Box of 12 single-pack wipes
12/case

- Convenient individually wrapped wipes are great for patient samples or travel use



CleanSmart CPAP Disinfectant Spray

Item#
CAP1018-L
16oz • **6/case**

CAP1018-S
2oz • **9/case**

- Kills 99.9% of viruses & bacteria
- Included on the EPA's List N: Disinfectants for Use Against SARS-CoV-2
- Active ingredient Hypochlorous Acid does not leave a chemical residue
- EPA Registration Number 89896-2
- Formulated for disinfecting surfaces of external medical equipment and external surfaces of respiratory equipment



Citrus II Mask Cleaning Spray

Item# **CAP1001**
1.5oz • **24/case**

Item# **CAP1002**
8oz • **12/case**

- All-natural cleanser for daily mask cleaning
- Available in 1.5oz travel size or 8oz non-aerosol spray cans



CLEANERS AND ACCESSORIES

CPAP Tube Cleaning Brush

Size	Item#
Standard 6ft	CAP1013
Slim 6ft	CAP1013SS

- Brushes all the way through a 6ft CPAP tube without leaving debris in the middle
- Stainless steel wire and soft nylon bristles

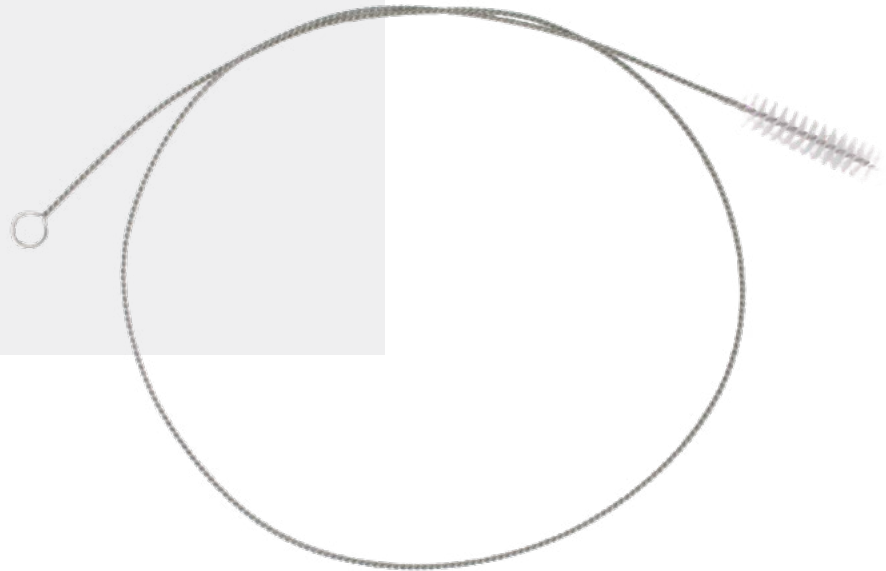

Filter Replacement Kit for SoClean 2

Item# **CAP1007S-KIT**
Each

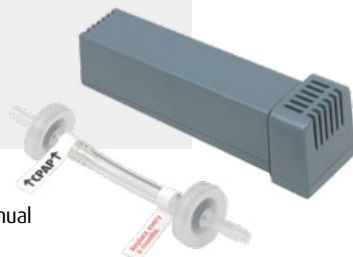

- With filter, check valve, retail packaging and instruction manual
- Replace every 6 months

Cleaner Accessories

ZCD100KIT	Filter and Check Valve Kit
CAP1016S	Quick Release Connector
ZCD100A-DS	Heated Tube Adapter for DreamStation/PR System One
ZCD100A-A10	Heated Tube Adapter Lid for ResMed AirSense 10
ZCD100A-S9	Heated Tube Adapter Lid for ResMed S9
ZCD100TC	Replacement Tube Connector (used when cleaning machine)
ZCD100A-P	Replacement Ozone Plug Adapter (used when not cleaning machine)
ZCD100IT	Replacement Injection Tube with Check Valve
ZCD100F	Replacement Filter
ZCD100PA	Replacement Power Adapter

CPAP BATTERIES

- No additional adapters needed • Outlet functions like a wall socket
- Universal 110-240V recharging conversion • 1-Year Warranty

Zopec Explore 5700

Item#
CAP1024-2157

Specs

- 1 USB-C (5V/3A) and 2 USB (5V/2.1A) ports
- 2.6 lbs
- 8.5 x 6 x 1 in
- 54,200 mAh /160 Wh
- FAA/TSA compliant (carry-on only)



Zopec Explore 8200

Item#
CAP1024-2182

Specs

- 1 USB-C (5V/3A) and 2 USB (5V/2.1A) ports
- 3.5 lbs
- 7.75 x 5.5 x 1.75 in
- 80,000 mAh /288 Wh
- Not FAA/TSA compliant (exceeds power capacity)



Zopec Explore Batteries Include

- Universal Wall Charger
- Fast Car Charger
- Travel Pouch
- Run any electronics with power requirement of 120 watts or under
- AutoSwitch and Bypass Technology for uninterrupted sleep when power outages occur
- Unlimited linking of multiple batteries together for longer use before recharging

CPAP CASH ITEMS

Zopec Voyage

Item#
CAP1024-21ZDP02

Includes battery, wall charger, and travel bag

Specs

- 1 USB-C (45W) and 2 USB (5V/2.1A) ports
- 2.15 lbs
- 7.25 x 5 x 1.75 in
- 40,000 mAh /146 Wh
- FAA/TSA compliant



Portable Outlet UPS CPAP Battery

Item#
CAP10082

Includes battery, wall charger, and travel bag

- Autoswitch technology: When power goes out, your CPAP stays on
- Three-prong AC outlet
- Two USB ports
- Digital display
- Convenient travel bag
- Meets TSA/FAA battery guidelines
- 1-year warranty
- Rated for over 500 charge cycles
- Recharges in less than 4 hours
- May be used for other devices powered by AC or USB
- AC and USB ports may be used simultaneously



Specs

- 2.875 lbs
- 5.375 in wide x 9 in long x 1.5 in tall
- Rated Capacity: 159Wh/14.4Ah
- Rated Voltage: 14.5V
- Charge Input: 16.8V/2A
- USB Output: 5V/4.2A
- AC Output: 110v AC 60hz/100w
- AC Adapter Input: 100V-240V/50-60Hz

Zopec powers more than CPAP

Reliable and multiuse backup solutions

ZOPEC EXPLORE 8200 is ideal for:

Ventilators

- Adds 9 hours of additional use to internal battery time

Power Wheelchairs

- A perfectly portable, lightweight solution at just 3 lbs

Stair Lifts

- Runs for 4 hours continuously (standard backup battery provides just 0-12 runs)

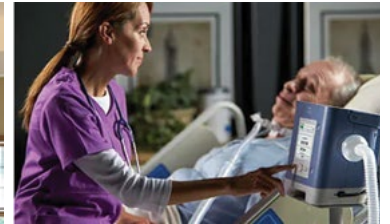

ZOPEC EXPLORE 5700 is ideal for:

Lift Chairs

- Provides 2-3 hours continuous operation. (Standard backup is two 9V batteries and only lifts one time)



Bypass keeps Zopec charged while devices are powered normally.

Autoswitch instantly changes the device's power source to Zopec in the event of a power outage.

CASH ITEMS

Snugz CPAP Mask Liners

Item#
CAP7001

Machine-Washable Liners
for Most Full Face Masks
2/pack

CAP7002

Machine-Washable Liners
for Most Nasal Masks
2/pack



- 2 per pack, 90-day supply
- Machine washable
- Fits MOST nasal or full face CPAP masks (Not recommended for ResMed Mirage Quattro or Respironics Amara View and Dreamwear)
- Blend of spandex, moisture-wicking polyester and lycra fibers
- Latex-free

Snugz is a machine washable, one-size-fits-most liner for CPAP masks that is designed to help reduce noisy leaks, prevent redness and irritation, and feel great against the skin. The liner helps to grip the skin and keep the mask in place around the nose and mouth, reducing the need for a chinstrap. The improved seal is especially beneficial for high-pressure/high-flow PAP patients and can reduce nightly sleep disturbances and AHI.

Soft Headgear Strap Covers

Item#
CAP2004



- Reduces strap marks
- No bulky and uncomfortable velcro
- Reduces strap irritation on sensitive skin
- Thick padding for extra comfort
- No need for clips – just slip wraps around headgear straps
- Easy and helpful for patients with arthritis in hands or fingers
- Can be machine washed and dried
- Wraps securely grip headgear and slide to adjust
- One size fits all
- Made from 230g Coral Velvet

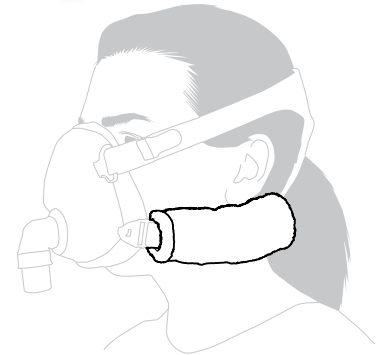

RemZzzs CPAP Mask Liners

Item#

CAP3001(S,M,L)

Liners for Full Face ResMed
& Respironics

OEM#	K1-FS	SMALL
	K2-FM	MEDIUM
	K3-FL	LARGE

CAP3002(S,M,L)

Liners for Full Face Fisher &
Paykel, Hans Rudolph, and
Sunset HCS

OEM#	K4-FS	SMALL
	K5-FM	MEDIUM
	K6-FL	LARGE

CAP3003(S,M,L)

Liners for Nasal
Respironics

OEM#	K7-NS	SMALL
	K8-NM	MEDIUM
	K9-NL	LARGE

CAP3004(S,M,L)

Liners for Nasal ResMed
and Fisher & Paykel

OEM#	K10-NS	SMALL
	K11-NM	MEDIUM
	K12-NL	LARGE

CAP3005L

Liners for Respironics
FitLife Mask

OEM#	6A-FLK	SMALL AND LARGE
	6B-FLK	EXTRA LARGE

CAP3006

Liners for Nasal Pillows
OEM# 7A-NPK

CAP3007

Liners for Respironics
DreamWear and Amara View
OEM# 6C-AVK

30-Day Supply

Boxes sold individually.
Full face and nasal mask RemZzzs include 30 facial liners
and 2 forehead liners.

- Increases compliance by adding a comfortable and absorbent pad to CPAP mask
- Reduces air leaks and protects skin from red marks



CASH ITEMS

CPAP Moisture Therapy

Item# **CAP6100L**
1oz Tube • 18/cas

- Formulated to prevent chafing, irritation, dryness or cracking from using a CPAP mask or other delivery device
- Apply to the face at the beginning of treatment and as needed
- Petroleum-free with aloe vera, vitamins A & E, and argan oil



Pur-Sleep CPAP Aromatherapy

Item# **CAP5001**
VaporClear Aromatherapy Starter Kit
OEM# VAPOR

Kit Includes:

- 1 aluminum diffusion stand
- 4 reusable diffusion pads
- 1.5ml bottle of Clear (peppermint, lime)
- 1.5ml bottle of Calm (eucalyptus, lavender, rosemary)



30ml Aromatic Refills

Scent/OEM#	Item#
Black Cherry	CAP5004-BCH
Calm	CAP5004-CLM
Clear	CAP5004-CLR
Dark Chocolate	CAP5004-DCH
Deep	CAP5004-DEE
French Vanilla	CAP5004-FRV
Fresh	CAP5004-FSH
Peace	CAP5004-PCE
Spice	CAP5004-SPC
Strawberry	CAP5004-STR

Item# **CAP5002**
Reusable Diffusion Pads
10/pack • OEM# DP10

Item# **CAP5003**
Replacement Aluminum Diffusion Tray
Each • OEM# TRAY

- Aromatherapy products specifically for use with CPAP
- Set up the diffuser right below the CPAP filter intake, add a drop of essential oil to the pad and the fragrance is drawn into the CPAP machine

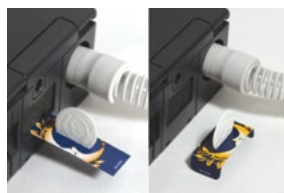

H2Doze Distilled Water for CPAP

Item# **CAPH20-6**
16.9oz Bottles
6/pack

- TSA cleared bottle when accompanied with CPAP machine
- Convenient 16.9 oz bottle perfect for travel
- Enough water for multiple nights of use
- Distilled water designed to protect CPAP equipment
- Allows patient to breathe healthy, safe air throughout the night



Quick Tube Release Connector

Item# **CAP1016**
Each

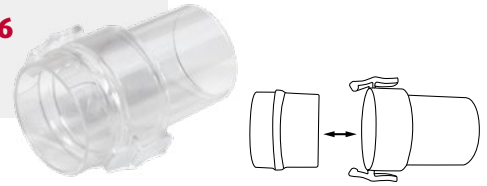

CPAP Final Bacteria Filter

Item# **BF2200**
22mm Bacteria Disk Filter
5/pack



Attach between the machine and tube for additional protection against bacteria and allergens

Circuit Connectors

Item# **RES013**
22mm OD x 15mm ID/
22mm OD
10/pack



Item# **RES014**
22mm OD x 22mm OD
With Lip
10/pack



Humidifier Tubing Adapter

Item# **RES016**
22mm ID x 22mm OD
with Lip
10/pack



Oxygen Bleed-In Adapter

Item# **RES019** 10/pack
22mm with 6mm
Rotating Stem

RES019-CAP 10/pack
With Stem Cap



Swivel Connector Silencer

Item# **VEN002**
For CPAP and Ventilator Circuits



CASH ITEMS

CPAP Pillows

Item# **CAP4003**
 CPAPMax Pillow
 Each OEM# 15-501R-1-920



Cool 3D Mesh Air-Flow
 Reduces heat and perspiration



Fiberfill
 Soft microfiber pillow top with hypoallergenic fiberfill

CPAPMax Replacement Cover
CAP4003RC
 Each OEM# 1-630-101-1-933

Replacement Pillow Case
CAP4003C
 Each OEM# 1-626-900-1-02

Item# **CAP4001**
 CPAP Pillow
 Each OEM# 14-101R-1-730



CPAP Pillow Replacement Cover
CAP4001RC
 Each OEM# 1-626-100-1-00

Replacement Pillow Case
CAP4001C
 Each OEM# 1-626-800R-1-00

Concave Center
 Improves airway alignment

Supportive Edges
 Extra support and comfort for side sleepers

Pressure-Free Side Cutouts
 Reduces mask interference

Ultimate Tube Control
 Tube tether allows tube to move with you throughout the night

Ventilated Perforated Foam
 Cool air flows through pillow

Memory Foam
 Molds to your facial features

High Resiliency Foam
 Support layer

Charcoal Infused High Resiliency Foam
 Charcoal neutralizes odors for freshness every night

BEFORE

Traditional pillows interfere with mask performance and can cause a stiff neck, shifting, leaks, and facial discomfort.



AFTER

The CPAPMax Pillow offers superb mask accommodation, excellent support, and unparalleled comfort.



CPAP Bedside Storage Bag

Item# **CAP1015**



- Well-made and stylish
- Designed to hold CPAP supplies such as a mask and tube
- Weighted lid allows bag to hang off top of nightstand or tabletop



CPAP Holder

Item# **CAP1010**



- Sits between mattress and boxspring
- Saves space by allowing machine to rest in the area between bed and nightstand
- CPAP machine is kept close to patient's head, allowing more freedom to move throughout the night
- Keeps machine below mask, to help prevent rainout



CASH ITEMS

Handheld CPAP Pressure Meter

Item#
CAP003

- Measures flow 0-18 cm/H2O
- Connects directly to the CPAP tubing without an adapter



Comfort Tubing Wrap

Item#
CAP2002
6ft Nylon
Tubing Wrap
Each
Compare to
ResMed
Tubing Wrap



- 6ft nylon wrap with fleece lining maximizes heat retention and reduces noise
- Zipper closure for ease of use

Deluxe Tubing Wrap

Item#
CAP2001
6ft Velour
Tubing Wrap
Each
Compare to
Respironics
Tubing Wrap



- 6ft plush velour material adds comfort while preventing rainout
- Zipper closure for ease of use

Both Tubing Wraps come in attractive retail packaging



CPAP HCPCS AND REPLACEMENT SCHEDULE

HCPCS	Item	Recommended replacement schedule
A4604	Heated Circuit Tubing	1 per 3 months
A7027	Combination Oral/Nasal Mask	1 per 3 months
A7028	Replacement Oral Cushion for Combination Oral/Nasal Mask	2 per month
A7029	Replacement Nasal Pillows for Combination Oral/Nasal Mask — Pair	2 per month
A7030	Full Face Mask	1 per 3 months
A7031	Replacement Full Face Mask Cushion or Liner	1 per month
A7032	Replacement Nasal Cushion or Liner	2 per month
A7033	Replacement Pillows — Pair	2 per month
A7034	Nasal or Pillows Mask	1 per 3 months
A7035	Headgear	1 per 6 months
A7036	Chinstrap	1 per 6 months
A7037	Tubing	1 per 3 months
A7038	Filter — Disposable	2 per month
A7039	Filter — Nondisposable	1 per 6 months
A7044	Oral Interface	
A7045	Replacement Exhalation Port	
A7046	Replacement Water Chamber	1 per 6 months
A9279	Monitoring Feature/Device	
E0470	BiLevel Device without Backup Rate	
E0471	BiLevel Device with Backup Rate	
E0561	Humidifier - Non-Heated	
E0562	Humidifier - Heated	
E0601	CPAP Device	

Due to the rapid changes in reimbursement, this information is for reference only. Sunset Healthcare Solutions cannot guarantee its comprehensiveness or accuracy. Sunset urges you to contact a reimbursement specialist for up-to-date information and advice.

Item#
CAP6100L
1oz Tube
18/case

- Prevent chafing, irritation, dryness or cracking from using a CPAP or oxygen delivery device
- Apply to the face at the beginning of treatment
- Petroleum-free with Aloe Vera, Vitamins A & E, and Argan oil



Item#
RES6104L
1oz Tube
18/case

Oxygen

Page

Pulse Oximeter	40
Firesafe	41
Concentrators	42
Batteries	42
Masks	43
Cannula	44-45
Tubing	45
Regulators and Conserver	46
Cylinder Carriers	48-49
Connectors and Adapters	50
Accessories	50-52
Cleaners	52
Bacteria and HEPA Filters	53
Concentrator Cabinet Filters	54-59
Caire/AirSep/SeQual	54
CHAD	55
Covidien Nellcor Puritan Bennett	55
DeVilbiss/Drive	56
Inogen	57
Invacare	57
Jumao, Lifestyle, Attendant	58
Nidek	58
3B	58
Respironics/Healthdyne	59

OXYGEN PRODUCTS

Finger Pulse Oximeter

Item# **RES5102**

- Oversized 1.3" OLED display face is the largest of any finger pulse oximeter
- Features large numeric font
- Five grades of brightness adjustment
- Displays SpO2, PR and PI parameters and pulse wave graph
- Offers buzzer, demo and visual alarm functions
- Easy to navigate menu sets alarm limits or switches buzzer on/off
- CE, ISO and FDA approved
- Includes lanyard and manual



FIRESAFE

Firesafe Thermal Shut-Off Valve

Item#
RES010
Each

Bidirectional



NEW
IMPROVED

- Smaller
- Laser etched
- Expiration date
- Human readable UDI
- Designed to last 5 years

- A thermal fuse designed to stop the flow of gas in the event that the downstream oxygen tubing is ignited
- Helps protect against oxygen tubing fires
- Helps keep patients safe no matter what method of oxygen delivery they use
- Offers a cost-effective solution to lower the risk of serious patient injury in an oxygen fire

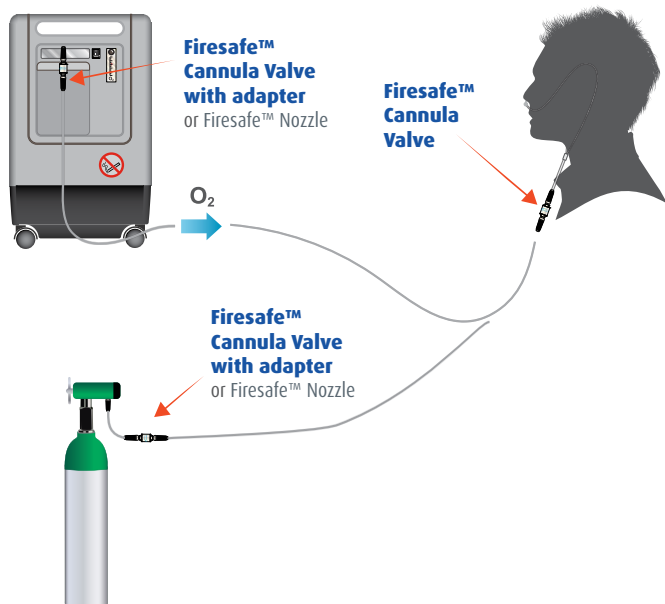

Home oxygen fires represent a much higher risk in the United States than the United Kingdom, where the fitting of thermal fuses for oxygen is mandatory.

Fatalities per 100,000 patients



* 1 death was reported among 73% of the patient population (2013-17)

FireSafe Kits

Item#
RES010KIT
2 Firesafe Valves
1 Tubing Connector

Item#
RES010CANNULAKIT
2 Firesafe Valves
1 Tubing Connector
1 Adult Soft Cannula



FireSafe Tubing Connector

Item#
RES010TC 100/case
RES010TC-10 10/case



FireSafe Nozzle

Item#
RES010FND-20
20/pack



Visit www.sunsethcs.com/acuteacare



FIRESAFE

OXYGEN CONCENTRATORS

Drive DeVilbiss Oxygen Concentrators

Item#
RES525DS
5 Liter

Item#
RES1025DS
10 Liter

- Built upon a legacy of reliable, field-proven concentrator models, the DeVilbiss 5 Liter and 10 Liter Oxygen Concentrators were designed with enhanced quality, durability and simplicity in mind
- Patented DeVilbiss Turn-Down Technology minimizes wear on internal components, reduces power consumption by 15% or more and extends the life of the concentrator
- Exclusive DeVilbiss OSD (Oxygen Sensing Device), standard on every unit, ensures patient safety and reliability for longer service intervals
- Readily accessible patient controls, protected cannula fitting and recessed humidifier nook to prevent damage
- Alarms Audible and visual high/low pressure, low flow, low oxygen, power fail, Oxygen Sensing Device



Drive DeVilbiss iG02 Portable Oxygen Concentrator

Item#
RES125D
iG02

Item#
RES125D-XB
iG02 with Extra Battery

- Settings 1-5 Pulse Dose
- SmartDose Auto-Adjusting Conserver Technology included
- Rugged design, including protective overmold
- Weighs less than 5 lbs
- Most sensitive conserver trigger on the POC market



OXYGEN BATTERIES

Zopec OxygenPro 4XL & 8XL

Item#
CAP1024-4XL
4XL

Item#
CAP1024-8XL
8XL



- Provide ~4 or ~8 hours backup at 5 L/M continuous flow for Oxygen Concentrators.
- Relax with powerful new backup for oxygen concentrators—and more.
- Batteries fully charge in 10 hours.



OXYGEN MASKS

Simple O₂ Mask

With 7ft Safety Tubing

Item# **RES2100**

Adult Size

50/case

Item# **RES2200V**

Pediatric Size

50/case



HCPCS# A4620

- 5-12 LPM
- Medium concentration
- Clear, soft vinyl for patient comfort
- Adjustable nose clip for secure seal



Partial Rebreather O₂ Mask

With 7ft
Safety Tubing
& Reservoir Bag

- 5-15 LPM
- High concentration

Item# **RES2101V**

Adult Size

50/case

HCPCS# A4620



Non-Rebreather O₂ Mask

With 7ft Safety Tubing
& Reservoir Bag

- 10+ LPM
- Low-resistance
check valves prevent
rebreathing and allow
exhaled gas to escape

Item# **RES2102**

Adult Size

50/case

Item# **RES2202V**

Pediatric Size

50/case



HCPCS# A4620



OXYGEN CANNULA

Cannula with Tubing

Adult Cannula with Tubing

Length	Material	Item#	Qty
4ft	Standard	RES1104	50/case
4ft	Soft	RES1104S	50/case
7ft	Standard	RES1107	50/case
7ft	Soft	RES1107S	50/case
15ft	Standard	RES1115	50/case
25ft	Standard	RES1125	25/case
25ft	Soft	RES1125S	25/case

HCPCS# A4615



- Clean, fresh look
- 1-6 LPM
- Curved nasal prongs for added comfort
- 6-channel safety tubing designed to prevent kinks
- Soft, lightweight material is memory free for long-term comfort

Item#

RES1207V

Pediatric Cannula with 7ft Supply Tube
50/case



RES1307V

Infant Cannula with 7ft Supply Tube
50/case



High Flow Soft Cannula

Length	Item#	Qty
4ft	RES1104SHF	25/case
7ft	RES1107SHF	25/case
15ft	RES1115SHF	25/case
25ft	RES1125SHF	25/case

HCPCS# A4615

- Now softer
- 6-15 LPM
- Maintains saturation for high-flow patients without a mask
- 6-channel supply tubing for safety



Cannula without Tubing

Adult Cannula without Tubing

Port	Material	Item#	Qty
Male	Standard	RES1100	50/case
Male	Soft	RES1100S	50/case
Female	Soft	RES1100FS	50/case

HCPCS# A4615

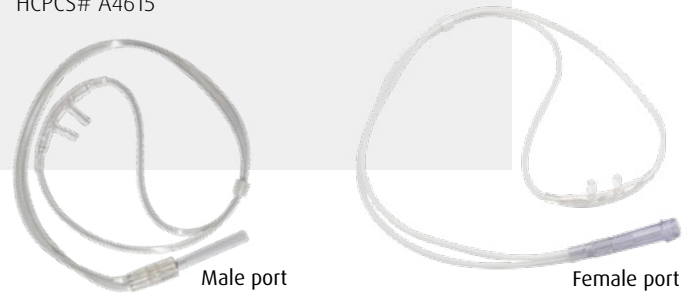

Male port

Female port

Soft Cannula with Universal Connector

Item# **RES1107SUC**

Adult Soft Cannula with Universal Connector and 7ft Supply Tube
50/case

HCPCS# A4615



NEW

Dual-Lumen (Demand) Cannula

Length	Item#	Qty
4ft	RES4144V	25/case
7ft	RES4147V	25/case

HCPCS# A4615

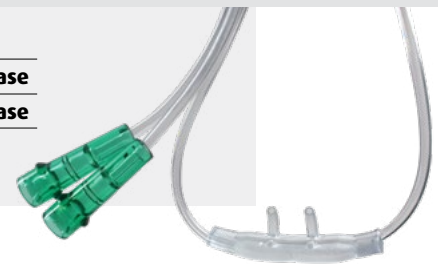

- 1-6 LPM
- Designed for use with dual port oxygen conservation delivery systems
- Dual tubing set provides independent tubes for oxygen delivery and sensing of patient breathing
- Smoothbore tubing

Tabbed Cannula

Item# **RES1007V**

Adult Tabbed Cannula with 7ft Supply Tube
50/case

HCPCS# A4615



OXYGEN CANNULA AND TUBING

Humidiflo High Flow Nasal Cannula

10/case

Size	Item#
Small	HFN001AS
Medium	HFN001AM
Large	HFN001AL

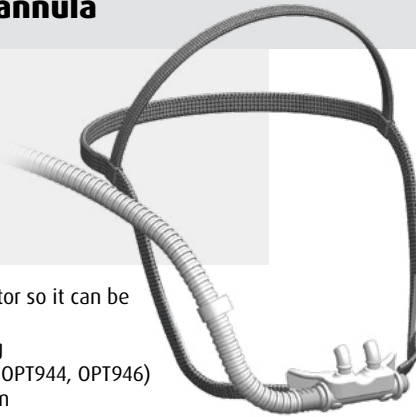

- Includes standard ISO connector and F&P adaptor so it can be used with almost any machine on the market
- Kink-free prongs and flexible, low-noise tubing
- Comparable to F&P OptiFlow cannula (OPT942, OPT944, OPT946)
- Can be used with F&P 950, 850, or Airvo system

With Nasal High Flow (NHF) therapy, patients benefit from warmed, humidified oxygen at a flow rate greater than those seen with conventional oxygen delivery devices, and more than peak inspiratory airflow. NHF treatment is better tolerable due to the heated and humidified air. The NHF apparatus is also smaller and more comfortable on the face than an NIV mask. Patients can continue eating, drinking and talking during treatment, leading to higher compliance. Delivery respiratory gases range from 2 - 60 L/min and O2 concentrations range from 21 - 100%. NHF is intended for patients in homes and long-term care facilities and may help prevent intubation.

Secure Cannula Stickers

Item# **RES080**
25 pairs/case

- Holds cannula in place
- Easy to use
- Flexible, sheer fabric
- Designed to let skin breathe and peel off without leaving residue
- Latex-free
- Individually wrapped pairs

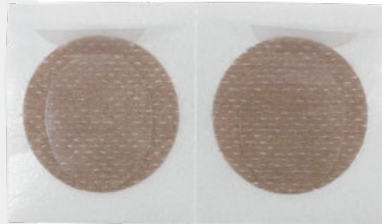

Comfort Cannula with Ear Cushions

Item# **RES1107EC**
7ft Cannula with
Ear Cushions
25/case
HCPCS# A4615



- 1-6 LPM
- Soft foam cushions add comfort and increase patient satisfaction
- Cushions are added during the manufacturing process so they stay in place and no assembly is required

Item# **RES020**
Cushions Only
50 Pairs/case

- Add cushions to existing cannula



OXYGEN TUBING

Oxygen Supply Tube



Length	Item#	Qty
7ft	RES3007	50/case
15ft	RES3015	50/case
25ft	RES3025	25/case
40ft	RES3040	20/case
50ft	RES3050	20/case

HCPCS# A4616

Oxygen Supply Tube — Green



Length	Item#	Qty
7ft	RES3007G	50/case
15ft	RES3015G	50/case
25ft	RES3025G	25/case
40ft	RES3040G	20/case
50ft	RES3050G	20/case

HCPCS# A4616

- Crush resistant with low memory to prevent kinking
- Great durability and comfort level
- Latex-free
- 1-6 LPM
- 6 channels

Visit www.sunsethcs.com/acutecare



OXYGEN REGULATORS AND CONSERVER

Mini Oxygen Regulator CGA 870 Style



"T" Handle for easy mounting — no tools needed

Barbed hose outlet for easy connection to the oxygen tubing

For use with E size or smaller cylinders: A, B, C, D, JD, E, M2, M4, M6, ML6, M7, M9, M15, M22, or M24.



Item# RES042
 Adult • Barbed
 0-8 LPM • **Each**
 0, .5, 1, 1.5, 2, 2.5, 3, 4, 5, 6, 7, 8 LPM

Item# RES043
 Adult • Barbed
 0-15 LPM • **Each**
 0, .5, 1, 1.5, 2, 3, 4, 5, 6, 8, 10, 15 LPM

Item# RES046
 Pediatric • Barbed
 0-4 LPM • **Each**
 0, 1/32, 1/16, 1/8, 1/4, 1/2, 3/4, 1, 1 1/2, 2, 3, 4 LPM

HCPCS# E1353

Mini Oxygen Regulator CGA 540 Style



Threaded DISS outlet

For use with M60 and larger cylinders: M60, M90, M, MM, M122, M250, H, J, T or other cylinders with CGA 540 style valve.



Item# RES044
 Adult • DISS
 0-8 LPM • **Each**
 0, .5, 1, 1.5, 2, 2.5, 3, 4, 5, 6, 7, 8 LPM

Item# RES045
 Adult • DISS
 0-15 LPM • **Each**
 0, .5, 1, 1.5, 2, 3, 4, 5, 6, 8, 10, 15 LPM

Item# RES047
 Pediatric • DISS
 0-4 LPM • **Each**
 0, 1/32, 1/16, 1/8, 1/4, 1/2, 3/4, 1, 1 1/2, 2, 3, 4 LPM

HCPCS# E1353

Both Regulators Feature

- Pressure gauge reads to 3000 PSI
- Easy-click flow selector knob
- 2-year warranty



Private label laser etching now available!

Ask your rep for details.

Oxygen Regulator CGA 540 Style Long Stem



Item# RES045L
 Adult • DISS
 0-15 LPM • **Each**
 0, .5, 1, 1.5, 2, 3, 4, 5, 6, 8, 10, 15 LPM

Bonsai Pneumatic Conserver

Item# RES049
 Single Lumen • Barbed Outlet
Each



- Delivers a uniform oxygen pulse at increments: 1, 2, 3, 4, 5, and 6
- Two continuous flow (CF) settings preset @ 2 LPM and 4 LPM
- Delivers up to a 6:1 savings ratio from 14-40 breaths per minute
- Senses breath/delivers oxygen in first half of inspiratory cycle
- Operating pressure range: 200-3000 PSI
- Light weight and quiet operation
- Easy to operate single selector knob
- Compact design fits easily in virtually any oxygen carry bag
- Limited 2-year warranty

Sample Oxygen Cylinder Specifications*

Use the handy chart below to determine which accessories to purchase for your oxygen cylinder.

* This information is intended to be used as a guide. Dimensions may vary by manufacturer. Sunset Healthcare Solutions does not sell oxygen tanks.



Older Name		A	B			C	D	JD	E		
Newer Name	M2	M4	M6	ML6	M7	M9	M15	M22	M24	M60	M/MM/M122
Diameter (in.)	2.5	3.2	3.2	4.3	4.3	4.3	4.3	5.3	4.3	7.3	8
Height (in.)	5.3	8.5	11.5	7.6	9.1	11	16.5	16.5	25.5	23	36
Empty Weight (lb)	0.7	1.6	2.2	2.8	3.3	3.7	5.3	8	7.9	22.3	39.5
Capacity (L)	42	113	164	165	198	255	425	640	680	1738	3455
Transport Method	CSBM6, CSBM6BP	CSBM6, CSBM6BP	CSBM6, CSBM6BP, CSBM6Flex, CSBM6-carrier	CSBML6M7, CSBML6-Hardshell	CSBML6M7	CSBM9, CSBM6BP, CSBM6Flex, RES038B	CSBD, CSBDDBP, CSBD1Roller, CSBD2Roller, RES038B, RES060		CSBE, CSBD1Roller, CSBD2Roller, RES038B, RES060	Not Portable	Not Portable
Regulator Type	RES042, RES043	RES042, RES043	RES042, RES043	RES042, RES043	RES042, RES043	RES042, RES043	RES042, RES043	RES042, RES043	RES042, RES043	RES044, RES045	RES044, RES045

OXYGEN HCPCS

A4615	Cannula, nasal
A4616	Oxygen tubing, per foot
A4620	Oxygen mask, variable concentration
E0424	Stationary compressed gaseous oxygen system, rental
E0431	Portable gaseous oxygen system, rental
E0443	Portable oxygen contents, gaseous (for use only with portable gaseous systems when no stationary gas or liquid system is used), 1 month supply = 1 unit
E0445	Oximeter device for measuring blood oxygen levels non-invasively
E0560	Humidifier, durable for supplemental humidification during IPPB treatment or oxygen delivery
E1353	Oxygen supply regulator
E1354	Oxygen supply wheeled cart
E1355	Oxygen supply stand/rack
E1390	Oxygen concentrator, single delivery port, capable of delivering 85% or greater oxygen concentration at the prescribed flow rate
E1391	Oxygen concentrator, dual delivery port, capable of delivering 85% or greater oxygen concentration at the prescribed flow rate
E1392	Portable oxygen concentrator, rental
K0738	Portable gaseous oxygen system, rental; home compressor used to fill portable oxygen cylinders; includes portable containers, regulators, flow meter, humidifier, cannula or mask and tubing

CYLINDER BAGS

Comfort Shoulder Bags

Cylinder	Item#
ML6/M7	CSBML6M7
C/M9	CSBM9
B/M6	CSBM6
D	CSBD



CASH ITEM

- Comfort flex shoulder strap
- Double zipper for easy access
- Machine washable



CSBML6M7

CSBM9

CSBM6

CSBD

Flex 02 Bag

Item# **CSBM6Flex**
 Reconfigurable Bag
 for M6 and M9
 Cylinders
Each

- Adjusts to 5 carrying modes



CASH ITEM

Backpack

Cylinder	Item#
B/M6/C/M9	CSBM6BP
D	CSBDBP



CASH ITEM



- Fully adjustable and comfortable backpack straps
- Machine washable
- Converts to either backpack or shoulder bag

Wheelchair/Scooter Carrier

Item# **CSBE**
 For E Cylinders
Each



CASH ITEM



- Multi-part stabilizer straps for easy chair attachment
- Machine washable

CYLINDER CARRIERS

Single Tank Rolling Bag/Backpack

Item#
CSBD1Roller
For D/E Cylinders
Each



CASH ITEM



Double Tank Rolling/Shoulder Bag

Item#
CSBD2Roller
For D/E Cylinders
Each



CASH ITEM



- May also be used with shoulder strap

ML6 Hardshell Tote

Item#
CSBML6-Hardshell
For Homefill Cylinders
Each



CASH ITEM



Cylinder Rack

Item# **RES038B**
Each

For D, E, or M9 Cylinders —
Lightweight, Durable
Plastic Composite Rack



Oxygen Cylinder Carrier

Item#
CSBM6-Carrier
Each
Soft Polyester Tote
for M6 Cylinders



- Tote handles
- Padded shoulder strap
- Fastening strap for mobility
- Holds up to 8 M6 tanks

D/E Cart

Item#
RES060
4/case

- Accommodates one D or E tank
- Sturdy yet lightweight (4.18 LBS welded metal construction)
- Adjustable height handle with PVC grip
- Large EVA Foam wheels have just the right amount of resilience for good traction and maneuverability
- Elegant, grey satin finish
- Bottom fork rest with rubber caps



OXYGEN CONNECTORS AND ACCESSORIES

Christmas Tree Connector

Item# **RES001**
Green without Swivel
10/pack



Item# **RES002**
Green with Swivel
10/pack



- Tapered and barbed nut and nipple assembly allows secure tubing connections
- For standard DISS threaded oxygen outlets
- Improved threading is easier to connect to regulators or flow meters

Oxygen Accessory Kit

Item# **RES1000**
RES002 Christmas Tree Connector - Swivel
RES012 Tubing Connector - Non-Swivel
RES017 Tubing Y-Connector
RES018 Tubing Connector - Swivel
RES032 Wrench
RES035 Brass Washer

Each



CUSTOMIZABLE KIT



- Order all common oxygen accessories in one easy-to-handle kit
- Contents can be customized to fit your needs

Oxygen Tubing Y-Connector

Item# **RES017**
Fits 3/16in and 1/4in ID Tubing
(All 3 sides are the same)
10/pack



- Connects 2 oxygen sources for higher flows

Oxygen Tubing Connector — Non-Swivel

Item# **RES012**
Fits 3/16in and 1/4in ID Tubing
10/pack



- Barbed ends ensure secure, leak-free connections

Tubing Reducer Connector

Item# **RES011**
Fits 3/16in, 1/4in, 5/16in, 3/8in, and 7/16in ID Tubing
10/pack



- Tapered on both ends to connect multiple sizes of tubing, works with suction, oxygen, and catheter tubing

Oxygen Tubing Connector — Swivel

Item# **RES018**
Male/Male **10/pack**



RES018-25 25/pack

RES018KIT-1
Female/Male **Each**



- Enhance patient mobility and comfort by minimizing twisting and tangling of oxygen supply tubing

Oxygen In Use Signs

Item# **RES003**
6in x 9in With String
50/pack



- Double-sided (English and Spanish)

Washers with Rubber Ring

Item# **RES035**
Brass
25/pack



Item# **RES036**
Aluminum
25/pack



OXYGEN ACCESSORIES

O₂ Starter Kit

Item# RES02KIT

- RES1107 Cannula with 7ft Tube x2
- RES3015 15ft Supply Tube x2
- RES002 Christmas Tree Connector — Swivel
- RES003 Oxygen In Use Sign
- RES012 Tubing Connector — Non-Swivel
- RES017 Tubing Y-Connector
- RES018 Tubing Connector — Swivel
- RES032 Wrench
- RES035 Brass Washer



CUSTOMIZABLE KIT

Disposable Bubble Humidifier 500 ml

Item#

RES050-50

Up to 15 LPM • 6 psi • 500 ml

50/case

HPCPS# E0560

OEM# HUM001



- Multi-threaded lid ensures a secure fit, preventing leaks and service calls
- Audible back pressure alarm activates at 6 psi
- No aluminum fitting in stem eliminates aluminum shreds often found in lower quality models
- Soft plastic diffuser reduces clogging due to mineral build-up
- Translucent jar provides improved visibility of jar contents
- Humidifier bottle lid is colored green/yellow, making it easy to tell patients on the phone how to change the bottle
- Bottle fill line is very easy to see
- Finger grips at the top of the bottle make the lid easier to screw on/off for the patient

Wrenches

Item# RES031

With Chain **10/pack**

Item# RES032

Without Chain **10/pack**

Item# RES031M

Metal Wrench with Chain for Post Valve Oxygen Cylinders and CGA 540 Style Regulators **5/pack**



- For use with post valve oxygen cylinders: A, B, C, D, JD or E tanks
- Made of tough, stress-resistant nylon

Humidifier Connectors

Item# HUM008

L-Connector 10in • **10/pk**

Item# HUM008L

L-Connector 21in • **10/pk**

Item# HUM008S

Straight Connector 9in • **10/pk**

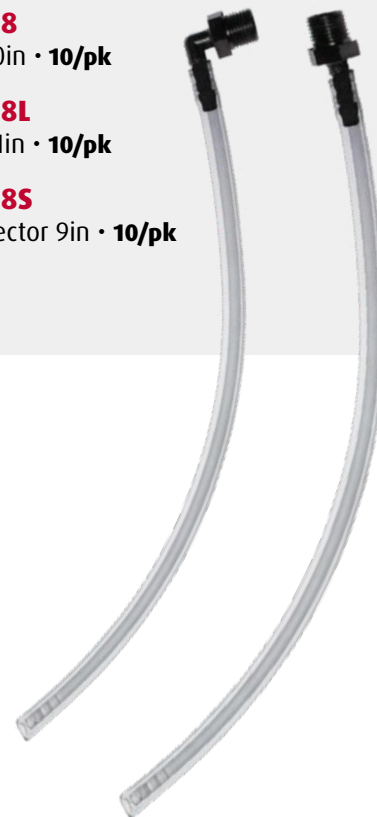

Water Traps

Item# RES037

Push On End Caps • **Each**

Item# RES037T

Threaded End Caps • **Each**



- Keeps water out of cannula
- Connects between cannula and supply tubing
- Removable end caps allows drainage of accumulated water
- 9cc water capacity in horizontal position

ACCESSORIES AND CLEANERS

Homefill Tubing Connector

Item# **RES039**
10/pack



- Compatible with Invacare, Drive, and Respiration homefill machines
- Durable, coiled tubing

Homefill Racks

Item# **RES039-RACKB**
For Invacare Perfecto2
4/case

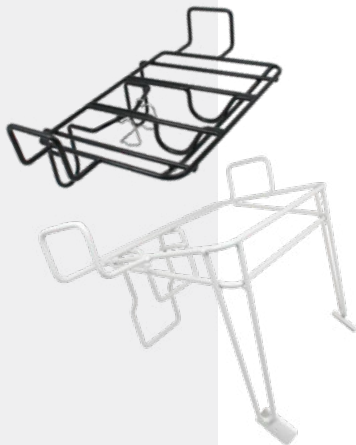

RES039-RACKW
For Invacare Platinum
4/case

RES039-RACKD
For DeVilbiss 525/1025 Series
4/case

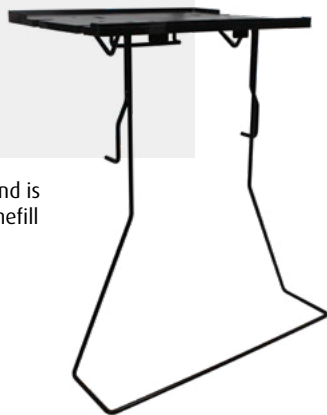

Easily attaches onto concentrator and is designed to conveniently hold Homefill and transfill oxygen systems.

Oxygen Liter Meter

Item# **RES034**
0-10 Liter/Minute
Each



- Oxygen pen
- Works with tanks and concentrators

RoEzIt Dermal Care

Item# **RES6104L**
1oz Tube • 18/cas



CASH ITEM

- Apply before beginning oxygen therapy and as needed during treatment
- Moisturizes the nose, lip, and over the ear where friction may cause discomfort from cannula
- Petroleum-free with aloe vera and vitamins A and E

Germicidal Deodorizing Cleaner

Item# **RES6100**
12/case
22oz spray bottles



- Heavy duty cleaner contains no bleach, alcohol, or phenols
- An effective bactericide, virucide, and fungicide
- Formulated to disinfect hard, non-porous surfaces

Germicidal Deodorizing Cleaner — Gallon

Item# **RES6102**
1 Gallon



- No-scrub, hospital strength germicidal cleaner
- Cleans, deodorizes, and disinfects surfaces, equipment and non-critical instruments

OXYGEN BACTERIA AND HEPA FILTERS

6in HEPA Capsule with Removable Sticker

Item# **BFH6S**
Threaded
Each



Intake Bacteria Filter

Item# **BF2222**
22mm fittings
5/pack



EverFlo Intake Filter

Item# **BF1001**
Each

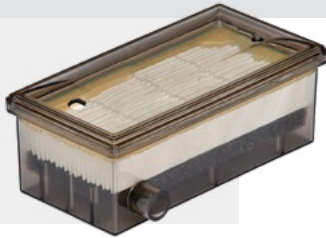

Extended Life Bacteria Filter with Muffler

Item# **OF6011**
Each

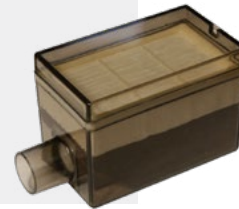

Extended Life Bacteria Filter

Item# **BF5000**
Nonthreaded
Each



Extended Life Intake Bacteria Filter

Item# **OF1025D**
Each



Extended Life Intake Bacteria Filter

Item# **BF1103**
Each



Intake Bacteria Filter

Item# **BF7000**
Each
For Jumao, Attendant,
and Lifestyle 5L



Final Bacteria Filter



Item# **BF516**
10/pack
1/4in Barbed
on Both Sides

Final Bacteria Filter — 1/4in to 3/8in

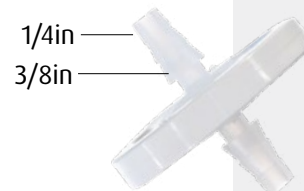

Item# **BF1438**
10/pack
1/4in to 3/8in
Stepped Barb
on Both Sides

Final Bacteria Filter — 1/4in to 1/2in

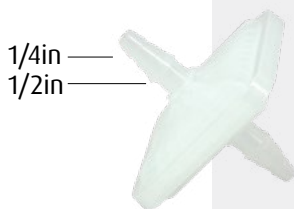

1/4in —
1/2in —

Item# **BF1412**
10/pack
1/4in to 1/2in
Stepped
Barb on Both Sides

Final Bacteria Filter — 3/16in



Item# **BF316**
10/pack
3/16 Stepped Barb and
1/4in Straight Barb
on Both Sides

CAIRE/AIRSEP/SEQUAL

CAIRE Companion 5



Item# **BF1103**
 Extended Life Intake
 Bacteria Filter
Each
 OEM# 2185



AirSep Newlife, QuietLife, Intensity



Item# **OF8002**
 Foam Cabinet Filter
10/pack
 5 1/4" x 4 7/8" x 7/8"
 OEM# F1-50-08-05



Item# **BF1438**
 Final Bacteria Filter
 1/4in to 3/8in
 Barbed
10/pack
 OEM# F1-30-03



Item# **OF8001**
 Felt Filter
10/pack
 1 7/8" OD x 3/4" ID x 1"
 OEM# M1 161-1



Item# **OF8002SP**
 Newlife Kit
 2 - OF8002
 1 - BF1438
 1 - OF8001
 Each

SeQual Integra



Item# **OF11005**
 Foam Cabinet Filter
10/pack
 7 5/8" x 3 5/8" x 5 x 3/4"
 OEM# 2185



Item# **BF5000**
 Extended Life
 Bacteria Filter
Each
 OEM# 2033

Item#
OF11005SP
 SeQual Kit
 2 - OF11005
 1 - BF5000
 1 - BF516
 Each



Item# **BF516**
 Final Bacteria Filter
 1/4in Barbed
10/pack

SeQual Eclipse

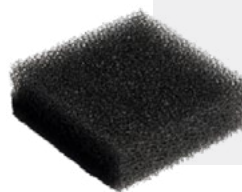

Item# **OF11006**
 Foam Cabinet Filter
10/pack
 2 1/2" x 2 1/2" x 3/4"

CHAD

Total O₂



Item# **OF11007**
Foam Cabinet Filter
10/pack
4 3/8" x 4" x 3/4"



Item# **BF2222**
Intake Bacteria Filter
22mm fittings
5/pack



KIT



Item# **OF3003**
Foam Intake Filter
for use with BF2222
10/pack
2 5/8" OD x 3/4" ID x 2 3/8"
OEM# H613

Item#
OF11007SP
CHAD Kit
2 - OF11007
1 - BF2222
1 - OF3003
Each

COVIDIEN NELLCOR PURITAN BENNETT

590 and 592A



Item# **OF6001**
Foam Cabinet Filter
10/pack
6 3/4" x 4 1/4" x 3/8"
OEM# 492672



Item# **BF5000**
Extended Life
Bacteria Filter
Each



KIT



Item# **BF316**
Final Bacteria Filter
3/16 Stepped Barb and
1/4in Straight Barb
10/pack
OEM# 492141

Item#
OF6001SP
590 and 592 Kit
2 - OF6001
1 - BF5000
1 - BF316
Each

SolAiris III, 303 Series



Item# **OF5004SP**
SolAiris III Kit
2 - OF5004
1 - BF1438
1 - BF5000
Each



Item# **OF5004**
Foam Cabinet Filter
10/pack
3 3/4" x 3 3/4" x 1/2"
OEM# 30302605



Item# **BF1438**
Final Bacteria Filter
1/4in to 3/8in Barbed
10/pack
OEM# MC29D-651



Item# **BF5000**
Extended Life
Bacteria Filter
Each

1025 Series



Item# **OF1025D**
Extended Life Bacteria
Filter
Each



Item# **OF5004**
Foam Cabinet Filter
10/pack
3 3/4" x 3 3/4" x 1/2"
OEM# 303DZ-605



Item# **BF1438**
Final Bacteria Filter
1/4in to 3/8in Barbed
10/pack
OEM# MC29D-651

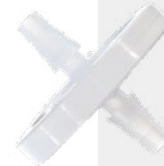

SolAiris V, 505, 515 Series



Item# **OF5005SP**
SolAiris V Kit
2 - OF5005
1 - BF6011
1 - BF1438
Each



Item# **OF5005**
Foam Cabinet Filter
10/pack
5 1/2" x 35/8" x 5/8"
OEM# 50502694



Item# **BF1438**
Final Bacteria Filter
1/4in to 3/8in
Barbed
10/pack
OEM# MC29D-651



Item# **BF5000**
Extended Life
Bacteria Filter
Each

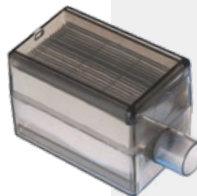

Item# **OF6011**
Extended Life
Bacteria Filter
22mm fittings
Each
Use if SolAiris was
manufactured
before Nov '03

525 DS Series



Item# **OF5004**
Foam Cabinet Filter
10/pack
3 3/4" x 3 3/4" x 1/2"
OEM# 303DZ-605



Item# **BF1438**
Final Bacteria Filter
1/4in to 3/8in Barbed
10/pack
OEM# MC29D-651

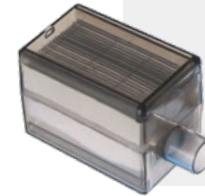
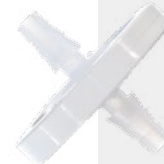

Item# **OF6011**
Extended Life Bacteria
Filter — 22mm fittings
Each

All MC Units



Item# **OF5001**
Foam Cabinet Filter
10/pack
6 1/8" x 3 1/2" x 1/4"
OEM# 444-514



Item# **BF5000**
Extended Life
Bacteria Filter • **Each**



Item# **BF1438**
Final Bacteria Filter
1/4in to 3/8in Barbed
10/pack
OEM# MC29D-651

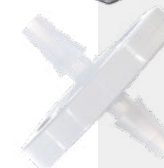

Item# **OF5001SP**
MC Kit
2 - OF5001
1 - BF5000
1 - BF1438
Each

INOGEN

One



Item# **OF11008**
Foam Cabinet Filter
10/pack
2 1/4" x 3/4" x 1/2"
OEM# RP-100

INVACARE

Mobilaire 3 and 5



Item# **OF9001**
Foam Cabinet Filter
10/pack
6 3/4" x 3 3/8" x 1/2"
OEM# 2000489

Item# **OF9001SP**
Mobilaire Kit
2 - OF9001
1 - BFH6S
1 - BF516
Each



KIT



Item# **BFH6S**
HEPA Filter
6in Capsule
Each
OEM# 2000806



Item# **BF516**
Final Bacteria Filter
1/4in Barbed
10/pack
OEM# P0750X030

Platinum 5 and 10



Item# **OF9002**
Foam Cabinet Filter
10/pack
9" x 27/8" x 1/2"
OEM#1107412

Item# **OF9002SP**
Platinum Kit
2 - OF9002
1 - BFH6S
1 - BF516
Each



KIT



Item# **BFH6S**
HEPA Filter 6in
Capsule with Sticker
Each
OEM# 2000806



Item# **BF516**
Final Bacteria Filter
1/4in Barbed
10/pack
OEM# P0750X030



Item# **HUM008S**
Straight Humidifier
Connector with
9in Tube
10/pk

Perfecto2



Item# **OF9004**
Foam Cabinet Filter
10/pack
6 7/8" x 3 3/4" x 1/2"
OEM# 1143492

Item# **OF9004SP**
Perfecto2 Kit
2 - OF9004
1 - BFH6S
1 - BF516
Each



KIT



Item# **BFH6S**
HEPA Filter 6in Capsule
Each
OEM# 2000806



Item# **BF516**
Final Bacteria Filter
1/4in Barbed
10/pack
OEM# P0750X030

HomeFill

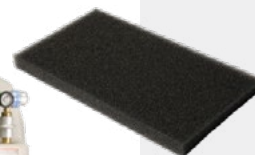

Item# **OF9001**
Foam Cabinet Filter
10/pack
6 3/4" x 3 3/8" x 1/2"

JUMAO, LIFESTYLE, ATTENDANT

Jumao, Lifestyle, Attendant



Item# **OF7000**
Foam Cabinet Filter
10/pack

NEW



Item# **BF7000**
Bacteria Filter
Each

NIDEK

Nuvo



Item# **OF11003SP**
Nuvo Kit
2 - OF11003
1 - BF1438
1 - BF5000
Each



KIT



Item# **OF11003**
Foam Cabinet Filter
10/pack
9 1/2" x 4" x 1/4"
OEM# 9250-1025



Item# **BF1438**
Final Bacteria Filter
1/4in to 3/8in Barbed
10/pack
OEM# 7631-1053

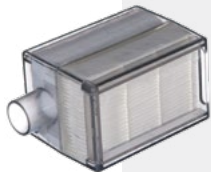

Item# **BF5000**
Extended Life
Bacteria Filter
Each
OEM# 9250-1028

Mark IV, V, V+



Item# **OF11004SP**
Mark Kit
2 - OF11004
1 - BF1438



KIT



Item# **OF11004**
Foam Cabinet Filter
10/pack
10" x 4" x 1/2"
OEM# 9007-6G37

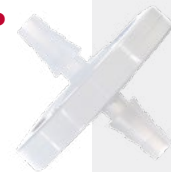

Item# **BF1438**
Final Bacteria Filter
1/4in to 3/8in
Barbed
10/pack
OEM# 7631-1053

3B

Stratus 5



Item# **OF6030**
Foam Cabinet Filter
10/pack
OEM# STR1030



Item# **BF6020**
HEPA Filter
10/pack
OEM# STR1020



Item# **BF316**
Final Bacteria Filter
3/16 Stepped Barb and 1/4in Straight Barb
10/pack
OEM# H621

RESPIRONICS/HEALTHDYNE

EverGo



Item# **OF1005**
Foam Cabinet Filter
10/pack
2³/₁₆" x 1¹/₁₆" x 3⁸/₁₆"
OEM# 900-150

Item#
OF1005SP
EverGo Kit
2 - OF1005
1 - BF316
Each



Item# **BF316**
Final Bacteria Filter
3/16 Stepped Barb and
1/4in Straight Barb
10/pack
OEM# H621

Millennium



Item# **OF1001**
Foam Cabinet Filter
10/pack
8¹/₄" x 4" x 3⁸/₁₆"
(3/16" notches)
OEM# H619

Item#
OF1001SP
Millennium Kit
2 - OF1001
1 - BF2222
1 - OF3003
1 - BF316
Each



KIT



Item# **BF2222**
Intake Bacteria Filter
22mm fittings
5/pack
OEM# H620



Item# **OF3003**
Foam Intake Filter
for use with BF2222
10/pack
2⁵/₈" OD x 3⁴/₁₆" ID x 2³/₈"
OEM# H618



Item# **BF316**
Final Bacteria Filter
3/16 Stepped Barb
and 1/4in Straight
Barb
10/pack
OEM# H621



Item# **OF1002**
Felt Filter
6/pack

NEW



Item# **OF2000**
Sieve Bed Filter
4.125in
5/pack

NEW



Item# **OF2001**
Sieve Bed Filter
2.875in
5/pack

Alliance

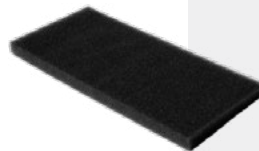

Item# **OF3002**
Foam Cabinet Filter
10/pack
8¹/₄" x 3³/₄" x 1²/₁₆"
OEM# 100-0078-10

Item#
OF3002SP
Alliance Kit
2 - OF3002
1 - BF2222
1 - OF3003
1 - BF316
Each



KIT



Item# **BF2222**
Intake Bacteria Filter
22mm fittings
5/pack
OEM# 100-6631-00



Item# **OF3003**
Foam Intake Filter
for use with BF2222
10/pack
2⁵/₈" OD x 3⁴/₁₆" ID x 2³/₈"
OEM# H618



Item# **BF316**
Final Bacteria Filter
3/16 Stepped Barb and
1/4in Straight Barb
10/pack
OEM# H621

EverFlo



Item# **OF1006SP**
Cabinet Filter Kit
(No Cover)
2 Filters, 1 Casing
OEM# 1055625



Item# **OF1006**
Cabinet Filter
10/pk
5¹¹/₁₆" x 4¹/₂" x 7¹⁶/₁₆"



Item# **OF1006-CASE**
Foam Cabinet Filter
Casing
10/pack



Item# **BF1001**
EverFlo Intake Filter
Each
OEM# 1038831



KIT

Item#
HUM008
Humidifier
L-Connector
With 10in
Tube
10/pk



Item# **BF316**
Final Bacteria Filter
3/16 Stepped Barb and
1/4in Straight Barb
10/pack
OEM# H621



Item# **OF2000**
Sieve Bed Filter 4.125in
5/pack

Other**Page**

Aerosol	61
Tabletop Nebulizers	62-63
Handheld Nebulizers	63
Nebulizer Kits	64
Nebulizer and Anesthesia Filters	65
Suction	66-69
Tracheostomy	70
Ventilator Filters, Masks, and Connectors	71
Ventilator Circuits	72-73
StrongArm Comfort Cane	74
Bath Safety	75
PPE	76-78
Maternity	79

OTHER**OTHER HCPCS**

A6402	Gauze - sterile, pad size 16 sq. in. or less, without adhesive border, each dressing
A4483	Heat and Moisture Exchanger — Disposable
A4626	Tracheostomy Cleaning Brush
A4628	Oropharyngeal Suction Catheter (Yankauer)
A4629	Tracheostomy Care Kit - for established tracheostomy
A7000	Suction Canister — Disposable
A7002	Tubing for Suction Pump
A7003	Nebulizer Set - Small Volume—Disposable
A7005	Nebulizer Set - Small Volume—Nondisposable
A7013	Nebulizer Compressor Filter— Disposable
A7015	Aerosol Mask used with Nebulizer
A7525	Tracheostomy Mask
E0570	Nebulizer with Compressor
E0600	Respiratory Suction Pump - home model, portable or stationary, electronic
E2601	General Use Wheelchair Seat Cushion - width less than 22 inches, any depth

AEROSOL

Aerosol Mask

Item# **RES2110**
Adult Size
50/case

Item# **RES2210**
Pediatric Size
50/case

HCPCS# A7015



- Clear, soft vinyl for patient comfort
- Adjustable nose clip for secure seal
- Connector accepts 22mm aerosol tubing
- Individually packaged



Peak Flow Meter

Item# **RES052**
10/case

50-800 L/min

- High performance
- Quality controlled
- Color areas indicator
- Slip design
- One-way valve
- Latex-free
- Phthalate-free



NEW

Item# **RES052MPD**
Pediatric Mouthpiece
for Peak Flow Meter
10/case

Drainage Bag with T-Adapter

Item# **RES070**
750cc • **50/case**



- Designed to ensure patients receive mist rather than liquid accumulated in the tubing
- Includes hanger and bottom drainage port
- Works with 22mm corrugated aerosol tubing

Drainage Bag with Y-Adapter

Item# **RES071**
750cc • **50/case**



SperaChamber

Anti-Static Valved Inhaler Chamber
for Metered Dose Inhaler

Chamber Only

Item#
RES195-10 10/pack
RES195-50 50/pack

Chamber with Mask
10/pack

Item#
RES195MS Small
RES195MM Medium

RES195ML Large (Adult)

- Inhalation valve
- Universal adapter
- Spiral vents
- Seal with exhalation safety valve
- Latex-free and DEHP-free
- Dog mask appeals to kids



TABLETOP COMPRESSOR NEBULIZERS

Compressor Nebulizers

Item#

NEB100

- Disposable T-Piece Kit (RES091)
- Foam Filters (BF018 x5)



NEB100-BAG
Carry Bag

NEB100-R

- Disposable T-Piece Kit (RES091)
- Reusable T-Piece Kit (RES093)
- Foam Filters (BF018 x5)

Sunny the Bear

NEB300BEAR

- Disposable Pediatric Mask (RES2210)
- Disposable T-Piece Kit (RES091)
- Foam Filters (BF018 x5)



NEB300BEAR-R

- Disposable Pediatric Mask (RES2210)
- Disposable T-Piece Kit (RES091)
- Reusable T-Piece Kit (RES093)
- Foam Filters (BF018 x5)

- Rust-resistant
- Quiet (below 60dBA)
- 6ml medication capacity
- Average nebulization rate above 0.2ml/min
- Particle size: respirable fraction 0.5 to 5um 0.5um 80%
- Compressor pressure range 30-45 PSI
- Operation pressure range 12-14 PSI
- Liter flow range 8-10 LPM

Gordon the Fish

NEW

NEB300FISH

- Disposable Pediatric Mask (RES2210)
- Disposable T-Piece Kit (RES091)
- Foam Filters (BF018 x5)



NEB300FISH-R

- Disposable Pediatric Mask (RES2210)
- Disposable T-Piece Kit (RES091)
- Reusable T-Piece Kit (RES093)
- Foam Filters (BF018 x5)

Basketball Pediatric Compressor Nebulizer

Item#

NEB300BASKETBALL-R

NEW

- Disposable Pediatric Mask (RES2210)
- Disposable T-Piece Kit (RES091)
- Reusable T-Piece Kit (RES093)
- Foam Filters (BF018 x5)



Sunset's Basketball Nebulizer brings some play to treatment time! The Basketball Nebulizer is packaged in a vivid and fun retail box that appeals to kids.

HANDHELD NEBULIZERS

Handheld Mesh Nebulizer

Item#
NEB402

NEW

With internal rechargeable battery

Included
Medication cup
USB cord
Mask
Mouthpiece
Portable bag
Manual



Particle Size MMAD < 5µm
Nebulization Rate 0.25ml/min-0.9ml/min
Medication Cup Capacity 10ml (Max)
Device Weight Approx. 1/4 lb
Device Size Approx. 1 1/2 x 2 x 3 7/8 inches

Mini Mesh Nebulizer

Item#
NEB400

Included
USB cord
Medicine cup
Mouthpiece
Adult mask
Pediatric mask
Carrying bag

- Runs on USB or 2 AA batteries
- Quiet
- Fast treatment times
- Small particle size
- Attainable for more patients

Replacement Parts

NEB400CUP	Medication Cup
NEB400MP	Mouthpiece
NEB400MASKP	Pediatric Mask
NEB400MASKA	Adult Mask



Handheld Compressor Nebulizer

Item#
NEB200

Included
Compressor
Medication cup
AC power adapter
Air hose
Elbow
Mouthpiece
Mask
4 AA batteries



- Runs on 4 AA batteries or AC power adapter
- Portable (small and weighs only 1/2 pound)
- Quiet (60dBA)
- Fine particle size (Approximately 3 microns)
- No replacement filter required

Visit www.sunsethcs.com/acutecare

NEBULIZER KITS

Disposable Nebulizer Kit with T-Piece

Item# **RES091**
Disposable
Single Patient
50/case
HCPCS# A7003

- Includes:
- 6cc jet nebulizer bottle
 - T-piece with mouthpiece and corrugated reservoir tube
 - 7ft supply tube



- Green, convex cone is easy to see and remove for simple cleaning and reassembly
- Easy to read medication jar provides a leak-proof seal

Reusable Nebulizer Kit with T-Piece

Item# **RES093**
Reusable — Single Patient
10/case
HCPCS# A7005

- Includes:
- 10cc jet nebulizer bottle
 - T-piece with mouthpiece and corrugated reservoir tube
 - 7ft supply tube

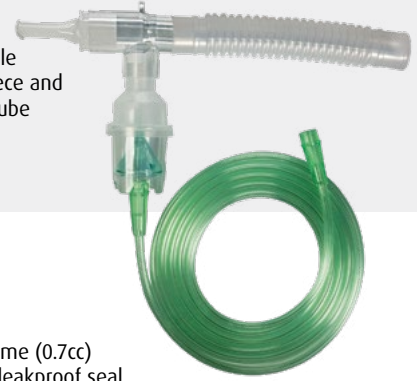

- Latex-free
- Dishwasher safe
- High capacity (10cc)
- CC volume markings
- Very low residual volume (0.7cc)
- 1/4 turn cap provides leakproof seal
- Works upright or at angles up to 45°

Disposable Nebulizer Kit with Angled Mouthpiece

Item# **RES096**
Disposable
Single Patient
50/case
HCPCS# A7003



- Includes:
- 6cc jet nebulizer bottle
 - Angled mouthpiece
 - 7ft supply tube



Disposable Nebulizer Kit with Mask

Item# **RES090**
Adult Size
50/case

Item# **RES092**
Pediatric Size
50/case



HCPCS# A7003

Includes

- 6cc jet nebulizer bottle
- Mask
- 7ft supply tube

Disposable single patient use for long term delivery procedures

6cc bottle is easy to assemble and disassemble



NEBULIZER FILTERS

Plastic Intake Filter

Item# **BF015**
10/pack
 HCPCS# A7013



Plastic Intake Filter with Head

Item# **BF016**
10/pack
 HCPCS# A7013



Plastic Intake Filter with Head

Item# **BF017**
5/pack
 HCPCS# A7013



Foam Filter

Item# **BF018**
10/pack
 HCPCS# A7013



Plastic Intake Filter for Respironics InnoSpire

Item# **BF026S**
10/pack
 HCPCS# A7013

- Mini
- MicroElite
- MiniElite



Nebulizer Filter Compatibility

Caire

Medi-Mist	BF018
-----------	-------

DeVilbiss

PulmoNeb	BF017
PulmoNeb LT	BF017
Sunrise Compact	BF018
Pulmo-Aide	BF017
Pulmo-Aide Compact	BF017
PulmoMate	BF017

Evo

AeroMax	BF018
SportsNeb	BF018
Super SportsNeb	BF018

Invacare

Passport	BF018
Envoy	BF018
Envoy Jr.	BF018
Select	BF018

John Bunn

Nebulite EV	BF018
LT2	BF018
LX	BF018

MedLine

SportsMist	BF018
------------	-------

Respironics

Inspiration 323	BF015
Inspiration 626 & 929	BF016
MisterNeb	BF016
Inspiration Elite	BF016
MiniElite	BF018
InnoSpire	BF026S

Salter

AIRE Plus	BF018
-----------	-------

Schuco

2000	BF018
3000	BF018

Sunset

NEB100 Series	BF018
NEB300 Series	BF018

SUCTION

Suction Machine

Item#
SU100DC
With Internal
Rechargeable
Battery

SU100AC
Without Battery



Comes with
Machine
Carry Bag
800cc Suction Canister
AC Adapter & Power Cord
6ft Suction Tubing
3.5in Suction Tube Connector
4.5in Suction Tube Connector
BF1438S Bacteria Filter

- Effective removal of respiratory fluids
- Durable yet lightweight
- Variable vacuum control
- Quiet and easy to use
- Two-year warranty

Accessories and replacement parts

SU100DC-PA DC Mobile Power Adapter (for car power outlet)
SU100DC-Adapt Replacement Power Adapter (without cord)
SU100DC-Cord Replacement Power Cord (without adapter)
SU100DC-BAG Carrying/Storage Bag
SU100-PA Car Charger (DC Mobile Power Adapter)
SU100DC-BATTERY Internal rechargeable battery replacement

Suction Canister

Item#
RES023AW
800cc • Single Use
48/case
HCPCS# A7000

Item#
RES025AW1200
1200cc • Single Use
48/case



- Float valve shutoff

Suction Kit for SU100DC

Item# **RES026S-SS**
RES023AW Suction Canister
RES024 Suction Tubing Connector 3.5in
RES024M Suction Tubing Connector 4.5in
BF1438S Bacteria Filter
RES025 Suction Tubing 1/4in x 6ft

HCPCS#
CANISTER - A7000
TUBING - A7002



Suction Filter Component Kit for SU100DC

Item# **RES024-MKIT**
RES024 Suction Tubing Connector 3.5in
RES024M Suction Tubing Connector 4.5in
BF1438S Bacteria Filter



Suction Filter Component Kit

Item# **RES024XL-3KIT**
RES024XL Suction Tubing Connector 16in
BF3812 Filter
RES028 Elbow Connector

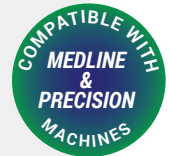

Suction Kit

Item# **RES026S-E**
RES023AW Suction Canister
RES024M Suction Tubing Connector 4.5in
RES025 Suction Tubing 6ft
RES028 Elbow Connector
BF3812 Bacteria Filter

HCPCS#
CANISTER - A7000
TUBING - A7002



SUCTION

Suction Machine Inline Filters

Item# **BF1438S**
1/4in to 3/8in
10/pack



Item# **BF3812**
3/8in to 1/2in
10/pack



Item# **BF1312**
1/3in to 1/2in
1/pack



Item# **BF516TS**
5/16in Barbed with
Threaded NPT
10/pack



Suction Tube Connectors

10/pack

Size	Item#
1.5in	RES024S
3.5in	RES024
4.5in	RES024M
6in	RES024L
10in	RES024L10
16in	RES024XL



NEW

Rubber Suction Elbow Connector Drive DeVilbiss Style

Item#
RES028
6/pack



Suction Elbow Connector Precision Medical Style

Item#
RES033
6/pack



Suction Tubing

1/4in

Length	Item#	Qty
18in	RES025S	50/case
6ft	RES025	10/case

3/16in

Length	Item#	Qty
18in	RES025-31618	100/case
20in	RES025-31620	100/case
6ft	RES025-31672	50/case

HCPCS# A7002



Bulb Tip Yankauers

Item# **TRAA001S**
Vented • **50/case**

Item# **TRAA002S**
Non-Vented • **50/case**

HCPCS# A4628



- Sterile
- Single patient use
- Not made with natural latex rubber

Visit www.sunsethcs.com/acutecare

CLOSED SUCTION

NEW

Standard

24 Hour Adult

Endotracheal 540mm

Item#	Description
VEN46001000A	10Fr
VEN46001000AM	10Fr, MDI Port
VEN46001200	12Fr
VEN46001200M	12Fr, MDI Port
VEN46001400	14Fr
VEN46001400M	14Fr, MDI Port
VEN46001600	16Fr
VEN46001600M	16Fr, MDI Port

Tracheostomy 305mm

VEN46011000A	10Fr
VEN46011000AM	10Fr, MDI Port
VEN46011200	12Fr
VEN46011200M	12Fr, MDI Port
VEN46011400	14Fr
VEN46011400M	14Fr, MDI Port
VEN46011600	16Fr
VEN46011600M	16Fr, MDI Port

72 Hour Adult

Endotracheal 540mm

Item#	Description
VEN56051000A	10Fr
VEN56051000AM	10Fr, MDI Port
VEN56051200	12Fr
VEN56051200M	12Fr, MDI Port
VEN56051400	14Fr
VEN56051400M	14Fr, MDI Port
VEN56051600	16Fr
VEN56051600M	16Fr, MDI Port

Tracheostomy 305mm

VEN56061000A	10Fr
VEN56061000AM	10Fr, MDI Port
VEN56061200	12Fr
VEN56061200M	12Fr, MDI Port
VEN56061400	14Fr
VEN56061400M	14Fr, MDI Port
VEN56061600	16Fr
VEN56061600M	16Fr, MDI Port



Neonatal/Pediatric

With Y-Adapter

Item#	Description
VEN66000500	305mm, 5Fr
VEN66000600	305mm, 6Fr
VEN66000700	305mm, 7Fr
VEN66000800	305mm, 8Fr
VEN66001000	405mm, 10Fr
VEN66000500M	305mm, 5Fr, MDI Port
VEN66000600M	305mm, 6Fr, MDI Port
VEN66000700M	305mm, 7Fr, MDI Port
VEN66000800M	305mm, 8Fr, MDI Port
VEN66001000M	405mm, 10Fr, MDI Port

Deluxe

Suction Control Switch

Ergonomic suction control switch with a built-in security lock to visually determine if the device is in the OFF/ON position. Offers a quick and easy, single handed operation design, which allows you to keep your eye on the patient and do no harm. One handed operation allows the free hand to support the ET or Trach device to ensure less trauma to the site.

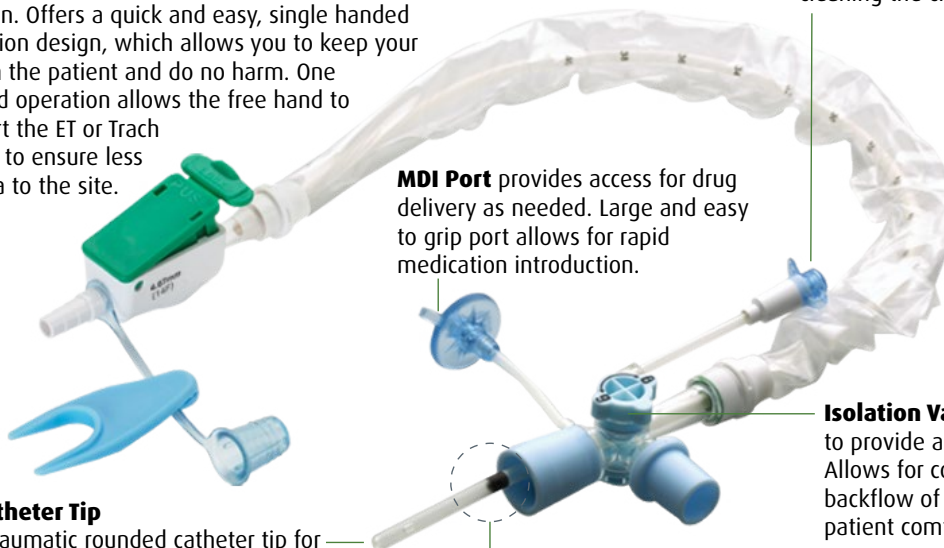

MDI Port provides access for drug delivery as needed. Large and easy to grip port allows for rapid medication introduction.

Catheter Tip

Atraumatic rounded catheter tip for minimal tracheal wall injury.

Irrigation Port offers a one-way valve to prevent backflow leakage and easy access for cleaning the closed suction system.

Isolation Valve seals the irrigation chamber to provide a better cleaning of the catheter. Allows for continuous ventilation and prevents backflow of saline during cleaning to ensure patient comfort and safety.

Black Ring Indicator ensures that the catheter is properly withdrawn from the ET or Trach device. Black ring must be visible in the plastic sheath after suctioning the patient.

CLOSED SUCTION

Deluxe

24 Hour Adult

Endotracheal 540mm

Item#	Description
VEN160100A	10Fr
VEN160100AM	10Fr, MDI Port
VEN160120	12Fr
VEN160120M	12Fr, MDI Port
VEN160140	14Fr
VEN160140M	14Fr, MDI Port
VEN160160	16Fr
VEN160160M	16Fr, MDI Port

With Wedge + Adapter

Item#	Description
VEN162100A	10Fr
VEN162100AM	10Fr, MDI Port
VEN162120	12Fr
VEN162120M	12Fr, MDI Port
VEN162140	14Fr
VEN162140M	14Fr, MDI Port
VEN162160	16Fr
VEN162160M	16Fr, MDI Port

Tracheostomy 305mm

VEN161100A	10Fr
VEN161100AM	10Fr, MDI Port
VEN161120	12Fr
VEN161140	14Fr
VEN161160	16Fr
VEN161160M	16Fr, MDI Port

With Wedge + Adapter

VEN163100A	10Fr
VEN163100AM	10Fr, MDI Port
VEN163120	12Fr
VEN163140	14Fr
VEN163160	16Fr

72 Hour Adult

Endotracheal 540mm

Item#	Description
VEN365100A	10Fr
VEN365100AM	10Fr, MDI Port
VEN365120	12Fr
VEN365120M	12Fr, MDI Port
VEN365140	14Fr
VEN365140M	14Fr, MDI Port
VEN365160	16Fr
VEN365160M	16Fr, MDI Port

With Wedge + Adapter

Item#	Description
VEN367100A	10Fr
VEN367100AM	10Fr, MDI Port
VEN367120	12Fr
VEN367120M	12Fr, MDI Port
VEN367140	14Fr
VEN367140M	14Fr, MDI Port
VEN367160	16Fr
VEN367160M	16Fr, MDI Port

Tracheostomy 305mm

VEN366100A	10Fr
VEN366100AM	10Fr, MDI Port
VEN366120	12Fr
VEN366120M	12Fr, MDI Port
VEN366140	14Fr
VEN366140M	14Fr, MDI Port
VEN366160	16Fr
VEN366160M	16Fr, MDI Port

With Wedge + Adapter

VEN368100A	10Fr
VEN368100AM	10Fr, MDI Port
VEN368120	12Fr
VEN368120M	12Fr, MDI Port
VEN368140	14Fr
VEN368140M	14Fr, MDI Port
VEN368160	16Fr
VEN368160M	16Fr, MDI Port

Neonatal/Pediatric

Item#	Description
VEN26000500	305mm, 5Fr
VEN26000500M	305mm, 5Fr, MDI Port
VEN26000600	305mm, 6Fr
VEN26000600M	305mm, 6Fr, MDI Port
VEN26000700	305mm, 7Fr
VEN26000700M	305mm, 7Fr, MDI Port
VEN26000800	305mm, 8Fr
VEN26000800M	305mm, 8Fr, MDI Port
VEN26001000	405mm, 10Fr
VEN26001000M	405mm, 10Fr, MDI Port

TRACHEOSTOMY

Tracheostomy Mask

Item#
RES2130
Adult Size
50/case

RES2230
Pediatric Size
50/case

HCPCS# A7525



- Latex-free
- 360° swivel in 2 places allows access from either side of the patient
- Comes with removable adapter to fit with aerosol or O₂ supply tubing

HMEs

Heat Moisture Exchangers



RES027FLEX
Flex HME —
Foam



RES027
T-HME



RES027OP
T-HME with
Oxygen Port



RES027IL
Inline HME —
Large Volume



RES027NE
Inline HME —
Neonatal

TV Range (mL)	300-1500	250-1000	250-1000	15-50	15-50
Moisture Output (mg H ₂ O/L)	33.8, Vt = 0.5L	27.3, Vt = 0.5L	26, Vt = 0.5L	31, Vt = 0.1L	30, Vt = 0.2L
Weight (g)	17	5	6.5	10	5
Resistance (cm H ₂ O)	0.5@30 LPM, 1.34@60 LPM	0.7@60 LPM	0.4@30 LPM	0.4@10 LPM	0.5@10 LPM
Dead Space (mL)	90	12.5	12	13	2.5
Connection (mm)	22M, 15F	15F	15mmF, 5.5mm Oxygen port	15M, 22M/15F	15M, 15F

Tracheostomy Ties with Fastener Tabs

20/case

One-piece
• Easy on

Item#
RES029 Adult
RES029P Pediatric

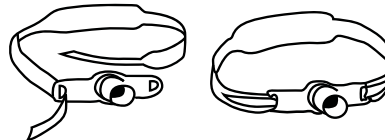

- Designed to provide secure stabilization of the tracheostomy tube
- Made from soft foam and cotton

Two-piece
• Easy off

Item#
RES030 Adult
RES030P Pediatric

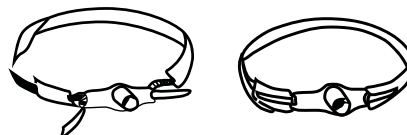

Tracheostomy Swivel Elbow Connectors

15mm ID x 15mm OD
10/pack



Item# **RES021**
With suction port



Item# **RES022**

Adapter for T-HME

Item# **RES027A**
Each



VENTILATOR FILTERS, MASKS, AND CONNECTORS

NIV Mask with Headgear — Non-vented

Each

Item#

CM038M Medium
CM038L Large



- Disposable, single patient use
- PC frame with PVC air cushion seal
- Low dead space for low CO2 buildup
- Clear mask allows a good view of mouth and nasal area
- Headgear with Velcro fasteners provide maximum versatility and movement
- Dual 360 degree swivels at the mask attachment and at the standard 22mm tubing attachment point

Bacteria Filter

Item#

BF2200
22mm Bacteria
Disk Filter
5/pack



Respironics Trilogy Ventilator Filter

Item#

CF1009F
2/pack

OEM# 1029330

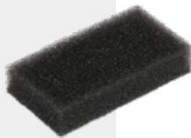

Air Inlet Vent Filter for Philips Respironics V60

Item#

VF002

For use with Philips Respironics V60
5/pack



Inlet Vent Filter for Pulmonetic LTV Series

Item#

VF001

For use with Pulmonetic LTV Series
5/pack



Valved T-Adapter — Adult

Item#

VEN001

22F-18F-22M/15F
Each



Ventilator Felt Filter

Item#

VF006

For use with NPB LP6 & LP10
10/pack



Swivel Connector Silencer

Item#

VEN002

For Ventilator Circuits and CPAP
Each



Circuit Connectors

Item#

RES013

15mm ID x 22mm OD
10/pack

RES014

22mm OD x 22mm OD
10/pack



Fixed Exhalation Port

Item#

VEN003

For Ventilator Circuits and CPAP
22 mm OD x 15 mm ID
Each

NEW



Visit www.sunsethcs.com/acutecare

SUNSET
HEALTHCARE SOLUTIONS

VENTILATOR CIRCUITS WITHOUT HUMIDIFIER CHAMBER

Passive Heated Breathing Circuit

Item#
VC1114

For use with MR850 Humidifier

10/case

OEM# RT1114

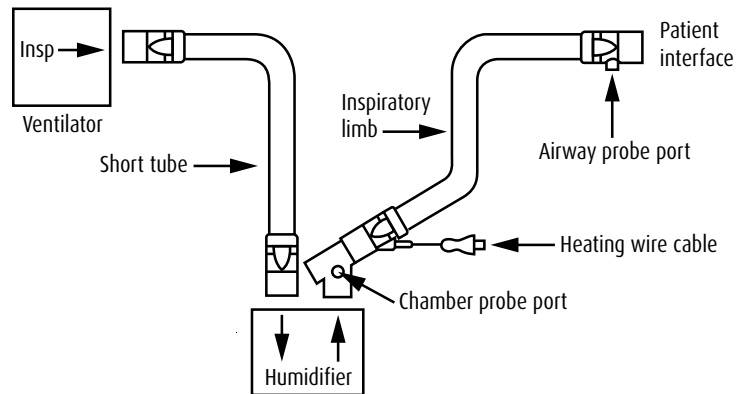

Passive Non-Heated Breathing Circuits

For use with Respronics Trilogy

Item#
VC1000

With swivel exhalation port

Each

OEM# 1073228 & 1073236



VC1100

With fixed exhalation port

Each

OEM# 1069467 & 1069468

Cough Assist Kits

Item#
CAKIT001

NEW

Each

OEM# 1090835

- 1 RES013 Circuit Connector
22mm OD, 15mm ID x
22mm OD
- 1 BF2200 Bacteria/Viral
Filter
- 1 TUB06 Circuit Tube
-
-

CAKIT002
Each

- 1 RES013 Circuit Connector
22mm OD, 15mm ID x
22mm OD
- 1 BF2200 Bacteria/Viral
Filter
- 1 TUB06 Circuit Tube
- 1 RES019 Oxygen
Enrichment Adapter



VENTILATOR CIRCUITS WITHOUT HUMIDIFIER CHAMBER

Non-Heated Breathing Circuits

For use with Respiration Trilogy
22mm cuffs
30/case



Item#	OEM#	Mode	Water Trap	Size	Tube Diameter
VC1001	1073223 & 1073232	Active	No	Adult	22mm
VC1001P	1073220 & 1073229	Active	Yes	Pediatric	15mm
VC1004	1069443 & 1069444	Passive	Yes	Adult	22mm
VC1004P	1073224 & 1073233	Passive	Yes	Pediatric	15mm

Item#
VC1001
Active Adult
OEM#
1073223
1073232

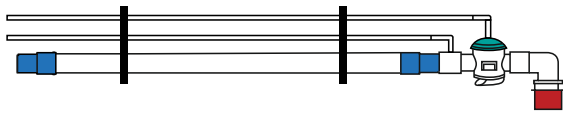
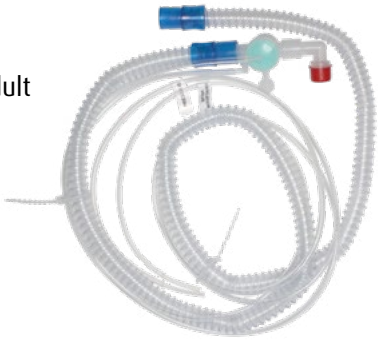

Item#
VC1001P
Active Pediatric
OEM#
1073220
1073229

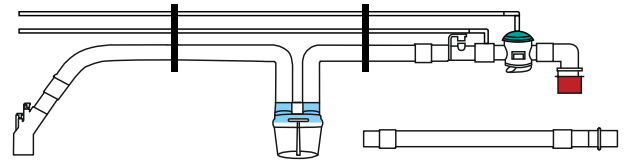
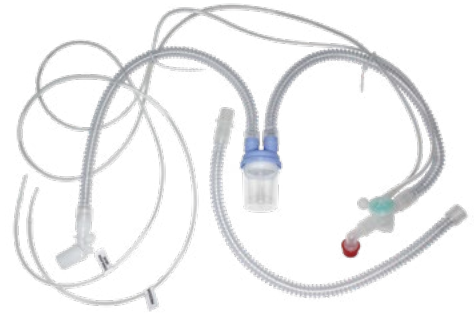

To use active circuits with Respiration Trilogy, simply cut ends off pressure and exhalation lines.

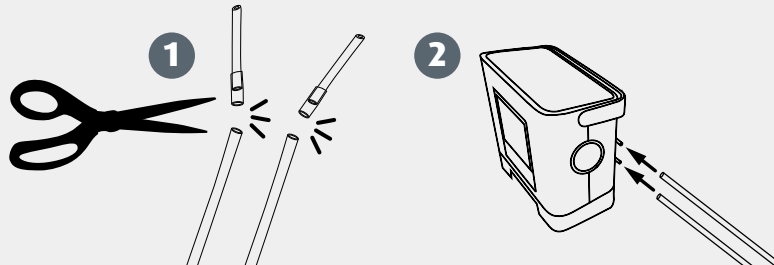

Item#
VC1004
Passive Adult
OEM#
1069443
1069444

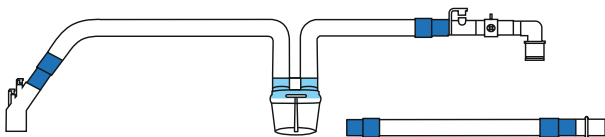

Item#
VC1004P
Passive Pediatric
OEM#
1073224
1073233

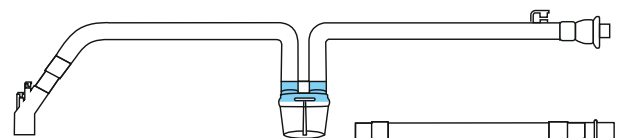

STRONGARM

StrongArm® Comfort Cane

NEW

- Ergonomic handgrip supports your forearm and relieves pressure from your wrist
- Offset bend centers grip over tip for maximum stability when cane is at the user's side
- Lightweight & strong
- 12 height adjustments
- Comfort Fit Handle
- Supports up to 500 lbs
- For left & right arm
- Self-standing base: Larger 'footprint' greatly improves traction and overall stability
- Safely walk on grass, gravel, sand, carpet, hard surfaces, and stairs



10/case

BM001	Black
BM001-BL	Blue
BM001-TI	Titanium

One of each color pack

BM001-3MC

STRONGARM COMFORT CANE



BATH SAFETY

PreserveTech™ 360° Swivel Bath Chair

Item#
BSE001

Compact and customizable, the PreserveTech™ Swivel Bath Chair provides a safe transfer in and out of the tub for those with limited mobility. The seat rotates a full 360° in either direction and automatically locks at 90° intervals to help prevent skin irritation and friction wounds during transfers. The seat height can be adjusted from 15"-22", and the padded armrests can be raised out of the way.



Splash Defense™ Transfer Bench

Item#
BSE002

Splash Defense™ Transfer Bench is the first of its kind to allow the shower curtain liner to remain inside the bath tub while a user is bathing. This unique product enhancement is essential to help prevent water from spilling out onto the bathroom floor, creating a danger zone for users and caretakers. The Splash Defense™ Transfer Bench provides security for the caretaker, while giving users back their independence and allowing them to bathe safely and privately again.



PreserveTech™ 360° Swivel Bath Chair

Item#
BSE003

Introducing the PreserveTech™ Universal Raised Toilet Seat. With our first ever, truly universal raised toilet seat users can set three different seat heights (2, 4 or 6") by maneuvering just two components. This seat can fit on most standard and elongated toilets and features two hygienic cutaways for easy cleaning. The pivoting armrests can be raised or removed, depending on user needs and bathroom space. This item also includes a lid with a recessed grip for effortless opening.



PPE

Mini Pistol Grip Non-Contact Thermometer

Item#
PPE4001-J
Infrared
Each



- Forehead mode for all ages
- Object measurement mode
- HD LCD display
- Battery: AAAx2
- Fever warning: 6 short double beeps
- Memory storage: 20 sets of measurable data
- Fahrenheit and Celsius
- Automatic shutdown: 10 seconds
- Professional accuracy (plus or minus 0.6 degrees F when measuring forehead temperatures from 89.6 through 107.9 degrees F)

Mini Wand Style Non-Contact Thermometer

Item#
PPE4002-A
Infrared
Each



- One second reading
- One click operation
- Fahrenheit and Celsius
- ¾ to 2-inch measuring distance

Nitrile Gloves

Ask us about our gloves and item numbers, which may vary based on available supply.



Simpli Germicidal Disposable Wipes

Item#
RES6108W
Canister of 160 wipes

NEW



- Bactericidal, Tuberculocidal, Fungicidal, Virucidal*
- Premoistened wipes containing a quaternary/alcohol-based solution.
- Made in the USA.
- Kills [†]SARS-CoV-2, Covid 19, Mycobacterium bovis – BCG (Tuberculosis—TB) in 1 Minute
- Kills Candida Auris in 2 Minutes

CleanSmart Disinfectant

Item#
CAP1019-C
23oz Spray Bottle
6/case



- CleanSmart is EPA listed as a broad-spectrum and hospital disinfectant
- EPA Registration Number 89896-2
- CleanSmart is formulated for disinfecting surfaces of external medical equipment and external surfaces of respiratory equipment
- CleanSmart is included on the EPA's List N: Disinfectants for Use Against SARS-CoV-2, the virus that causes COVID-19
- Active ingredient Hypochlorous Acid does not leave a chemical residue

CleanSmart Alcohol-Free Hand Cleanser

Item#
CAP1021-HC8
8oz Spray Bottle
6/pack

CAP1021-HC2
2oz Spray Bottle
9/pack

- Same active ingredient as CleanSmart cleaner, in a hand cleanser.



PPE

Disposable 3-Ply Face Mask

Item#

PPE1002PS

Adult • 6 7/8 x 3 3/4 in

Box of 50 Masks

- Hypoallergenic
- Comfortable
- Breathable
- Fiberglass-free
- 3 layers of polypropylene (a meltblown layer between two soft non-woven layers)



Disposable Face Shields with Elastic Strap

Item#

PPE3001FS-F

Adult

Each

- High-density foam forehead rest
- Clear, anti-fog vision



PPE3002PFS-M

Pediatric
Monster Design

Each

PPE3002PFS-A

Pediatric
Animal Design

Each



Disposable Level 2 Surgical Face Mask

Item#

PPE1002SM

Box of 50 Masks

- Medical classification and 510(k)
- 98% bacterial filtration efficiency
- Rated for moderate risk levels of aerosols, spray, and/or fluids



Disposable Tearaway Gown

Item#

PPE5002

25/pack

- Level 3 ASTM F3352
- Individually sealed
- Made in the USA



BOLT Clean Air System

NEW

Item#
BOL1001
Each



BOLT is the 360° commercial unit that can be used safely while people are in the room, allowing for a continuous and comprehensive germicidal UVC disinfection that kills 99.9% of viruses. BOLT uses ultraviolet light to create an eradication zone, destroying viruses, bacteria, and other pathogens at a DNA level, and disabling their ability to multiply and cause disease.

BOLT safely eradicates viruses with shielded UVC light. Its state-of-the-art engineered louver system protects people from direct UVC light rays. This means BOLT provides real time air sanitation and protection for customers, clients, employees, and students while they work, shop, learn, and dine indoors. BOLT's patent pending design comes from the team's decades of niche experience with plastics.

BOLT's technology is a recommended method to reduce exposures to SARS-CoV-2, the virus that causes COVID-19.

Included:

- 1 BOLT Louver System
- 1 UV-C Germicidal Light Bulb
- All necessary mounting hardware
- Operating instructions

MATERNITY

Twist Double Electric Breast Pump

Item#
MAT2300T1

NEW

The Motif Twist is ideal for moms looking for portable convenience. The Twist works at home or on-the-go, with an AC adapter or battery power option. Users simply twist the knob to select different suction and massage settings. The blue LED light timer tracks pumping sessions. The Twist allows moms to customize their pumping experience to fit their comfort level.

- Super lightweight design. Weighs less than ½ a pound.
- Single or double pumping session.
- Closed system. Backflow prevention keeps the motor and tubing clean, preventing contamination.
- Dual power options. Use it stationary or on battery power (4 AA batteries).
- Quiet motor for discreet pumping.
- Adjustable suction pattern designed for maximum letdown.



Motif BiliTouch™ Phototherapy Blanket

Item#
MAT2300EAB

NEW

The Motif BiliTouch™ phototherapy blanket is a biliblanket designed by healthcare professionals to treat newborn infants diagnosed with jaundice (hyperbilirubinemia). This portable, convenient phototherapy treatment device allows your patients to continue to hold, feed, and care for their baby while reducing high bilirubin levels at home.

- Convenient, ultra-portable phototherapy treatment with battery-powered option
- Patient-centered, lightweight design facilitates bonding with newborn infant
- LED light source, no fiber optic cables for easy positioning



Visit www.sunsethcs.com/acutecare

SUNSET
HEALTHCARE SOLUTIONS

