

Active Adult

Item#
VC1001
30/case
OEM#
1073223
1073232

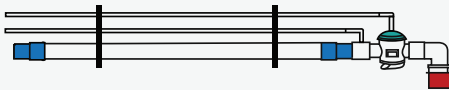
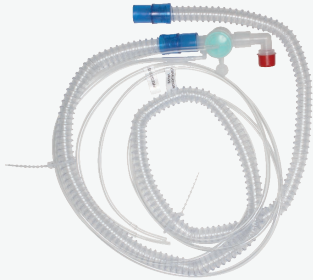

Passive Adult

Item#
VC1004
30/case
OEM#
1069443
1069444

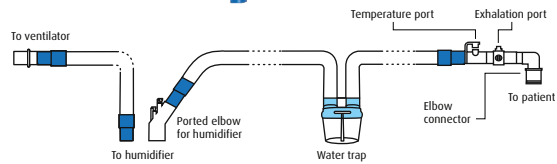

Active Pediatric

Item#
VC1001P
30/case
OEM#
1073220
1073229

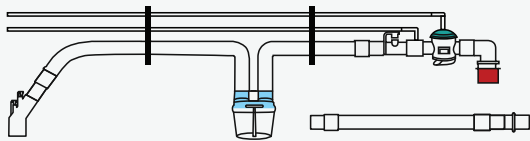
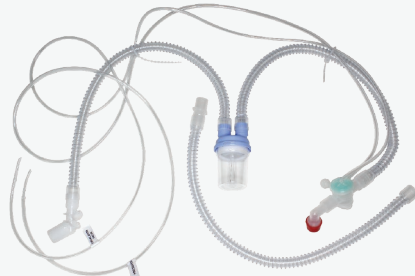

Passive Pediatric

Item#
VC1004P
30/case
OEM#
1073224
1073233

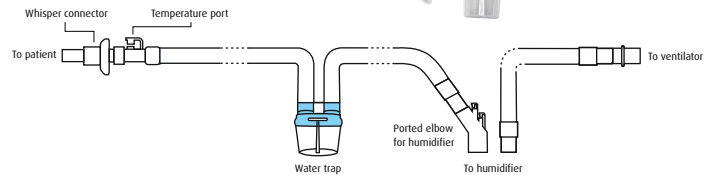

To use active circuits with Respironics Trilogy, simply cut ends off pressure and exhalation lines.

1

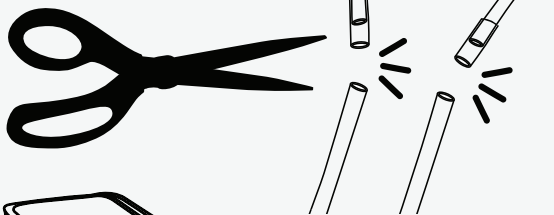

2

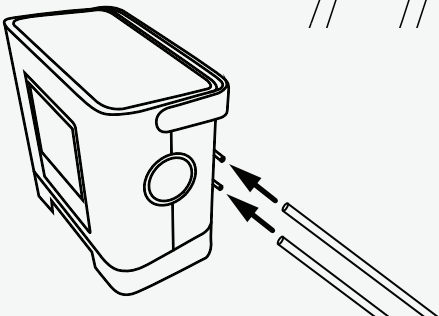

Passive Adult

Item#
VC1000
Each
OEM#
1073228
1073236

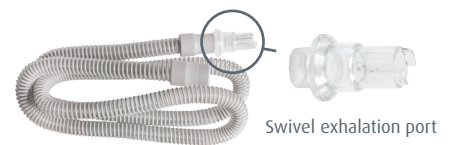

Item#
VC1100
Each
OEM#
1069467
1069468

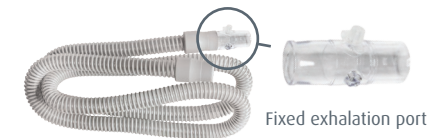

Heated Passive Adult
for use with
Fisher & Paykel
MR850
Humidifier

Item#
VC1114
10/case



SCAN TO LEARN MORE

