

SUNSET



YEARS



Homecare Product Catalog

POLICIES

Ordering Options

Three Easy Ways To Order

Phone

(877) 5-SUNSET (877-578-6738)

Our customer service professionals are here to assist you M-F 8:00 AM – 5:00 PM Central Time.

Fax

312-997-9985 — Accepted 24 hours a day.

Email

sales@sunsethcs.com

Payment Methods

Payment Portal and ACH

Visit www.sunsethcs.com/paymentportal to pay online with ACH or credit card.

Net 30-Day Payment Terms

For qualified companies. A 1.5% monthly finance charge will be assessed on all past due invoices.

COD

For non-qualified companies.

Credit Card

We accept all major credit cards. A processing fee may apply. After 10 days of invoice date, a surcharge of 2.5% will be applied.



Shipping

Ask your rep about shipping to various locations and our drop shipping partners.

UPS

Whenever possible, orders ship via UPS. If another carrier is desired, please contact your sales rep.

All orders are packed in the smallest boxes available and combined with other products on the order to reduce shipping costs.

All products ship prepaid and are added to the invoice.

All products ship from Elgin, IL or Phoenix, AZ. Please refer to UPS.com for transit times.

Damaged Merchandise

Call us within 10 days. Keep original cartons for UPS inspection.

We proudly partner with



Customer Service

Returns

Contact us within 7 days of receiving your shipment.

All items must be unopened and in their original packaging. Call us for a return authorization number. There is no restocking charge on orders returned within 20 days of invoice. Orders returned after 20 days may be assessed a restocking fee of 15%. No returns after 90 days.
(877) 5-SUNSET (877-578-6738)

Central Distribution Center

Sunset Healthcare Solutions
2725 Alft Ln
Elgin, IL 60124

Western Distribution Center

Sunset Healthcare Solutions
6750 W Van Buren St Ste 100
Phoenix, AZ 85043

Problems

Please call us immediately if you have any complaints (it is helpful to ask for the customer service representative with whom you placed your order).
Or email us at: customerservice@sunsethcs.com

Questions?

Our experienced customer service staff will be glad to provide you with information. Just give us a call.

Pricing

All prices are in U.S. Dollars.
Taxes are added where applicable.
We make every effort to hold pricing throughout the year. However, prices are subject to change without notice.

Contact us for more information on fulfillment and compliance solutions that best fit your needs.

CONTENT

CPAP

	Page
Masks and Replacement Parts	4-12
Sunset Healthcare Solutions	4-6
Sleepnet	7-9
Circadiance	10-11
InnoMed	12
Airway Management	12
Sleep Apnea Appliances	13
Tubing	14-15
Filters	16-24
Respironics	16-17
ResMed	18-19
Fisher & Paykel	20
3B	20
AEIOMed	21
Beyond	21
Breas/GE	21
CareFusion/Viasys	22
Covidien Nellcor Puritan Bennett	22
DeVilbiss	23
Evo Medical	23
Healthdyne	24
Invacare	24
Löwenstein	24
Resvent	24
ProBasics	24
Humidifier Chambers	25
Chinstraps	26-27
Headgear	27
Cash Items	28-35
Cleaners and Accessories	28-29
Comfort	29
Battery	30
Auto CPAP	31
Mask Liners and Soft Headgear Covers	32
Self Care	33
Connectors, Adapters, and Inline Filter	33
Pillows	34
Storage	34
Hush Strips	35
Tubing Wraps	35

Oxygen

	Page
Pulse Oximeter	36
Firesafe	37
Concentrators	38
Masks	39
Cannula and Cannula Accessories	40-41
Tubing	41
Regulators and Conserver	42
Cylinder Carriers	44-45
Connectors	46
Accessories	46-48
Cleaners	48
Analyzers	49
Celon Wet Bands	49
Bacteria and HEPA Filters	50
Concentrator Cabinet Filters	51-56
Caire/AirSep/SeQual	51
CHAD	52
Covidien Nellcor Puritan Bennett	52
DeVilbiss/Drive	53
Invacare	54
Rhythm HC	55
Jumao, Lifestyle, Attendant, Medacure	55
3B	55
Nidek	55
Respironics/Healthdyne	56

Other

	Page
Disinfectants	57
Aerosol	58
Tabletop Nebulizers	59
Handheld Nebulizers	60
Nebulizer Kits	61
Nebulizer and Anesthesia Filters	62
Suction	63-65
Closed Suction Systems	66-67
Tracheostomy	68
Ventilator Filters, Masks, and Connectors	69
Ventilator Circuits	70-71
StrongArm Comfort Cane	72
Bath Safety	73
Maternity	74-75
Wound Care	76-79

SUNSET HEALTHCARE SOLUTIONS

Sol Full Face CPAP Mask

Mask with Headgear and Replaceable Cushion

Size	Item#
Small	CM205S
Medium	CM205M
Large	CM205L

Replacement Cushions

Size	Item#
Small	CUCM205S
Medium	CUCM205M
Large	CUCM205L

Sol without Headgear

Size	Item#
Small	CM205SNH
Medium	CM205MNH
Large	CM205LNH

HCPCS#
 MASK - A7030
 HEADGEAR - A7035
 CUSHION - A7031



Ask us about our 30-day mask guarantee

HG205 Replacement Headgear - Fits Most

A premium mask without the premium price

Easy pop cushions

Cushions attach or detach from mask in an easy pop; no need to painstakingly align pieces

Quiet vent

Honeycomb design reduces airflow erosion intensity for gentle and quiet flow

Quick release connector

Rapidly and easily separates or connects mask and the tube

Soft and light headgear

Skin-friendly fabric, light and stable design helps patients comfortably adapt to treatment

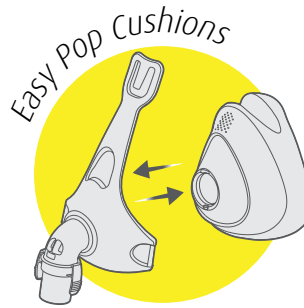

Available to add to your formulary in SleepGlad

Sol comes in attractive retail packaging

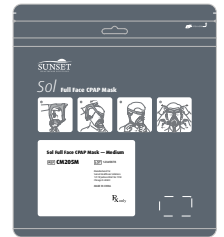

Ray Pediatric CPAP/NIV Masks

Mask with Headgear, Tube, and Replaceable Cushion

Size	Item#	Comparable OEM#
Small	CM061S	AG-PEDFF-S
Medium	CM061M	AG-PEDFF-M
Large	CM061L	AG-PEDFF-L
Extra Large	CM061XL	AG-PEDFF-XL

Replacement Cushions

Size	Item#	Comparable OEM#
Small	CUCM061S	AG-PEDFF-CS
Medium	CUCM061M	AG-PEDFF-CM
Large	CUCM061L	AG-PEDFF-CL
Extra Large	CUCM061XL	AG-PEDFF-CXL

Replacement Headgear

Size	Item#	Comparable OEM#
Sm/Med	HG061S	AG-PEDFF-HGS
Lg/XL	HG061L	AG-PEDFF-HGL

HCPCS#
 MASK - A7030 · HEADGEAR - A7035 · CUSHION - A7031

• Comparable to Nonny masks



Nasal Mask with Headgear, Tube, and Replaceable Cushions

Size	Item#	Comparable OEM#
S&M Cushions	CM060-KITS	AG-PEDKIT-S
L&XL Cushions	CM060-KITL	AG-PEDKIT-L

Replacement Cushions

Size	Item#	Comparable OEM#
Small	CUCM060S	AG-PEDKIT-CS
Medium	CUCM060M	AG-PEDKIT-CM
Large	CUCM060L	AG-PEDKIT-CL
Extra Large	CUCM060XL	AG-PEDKIT-CXL

Replacement Headgear

Size	Item#	Comparable OEM#
Small	HG060S	AG-PEDKIT-HGS
Large	HG060L	AG-PEDKIT-HGL

HCPCS#
 MASK - A7034 · HEADGEAR - A7035 · CUSHION - A7032



SUNSET HEALTHCARE SOLUTIONS

Sunset Deluxe Full Face CPAP Masks

Mask with Flex Tube, Headgear, and Replaceable Cushion

Size	Item#
Small	CM005S
Medium	CM005M
Large	CM005L

Unobtrusive design offers a clear line of sight

HG003 Headgear - Fits Most
HG003XL Headgear - XL

CMSIZE01
Deluxe Sizing Guide

HCPCS#
MASK - A7030
HEADGEAR - A7035
CUSHION - A7031



Replacement Cushions

Size	Item#
Small	CUCM005S
Medium	CUCM005M
Large	CUCM005L

Mask with Adjustable Forehead T, Headgear, and Replaceable Cushion

Size	Item#
Small	CM105S
Medium	CM105M
Large	CM105L



- 360° dual-swivel elbow port allows for free movement while connected to the tubing
- Quick-release clips make it easy to remove the mask without resetting the headgear
- Ultra-lightweight silicone replaceable cushion increases comfort while maintaining optimal seal

Mask without Headgear

Size	Item#
Small	CM005SNH
Medium	CM005MNH
Large	CM005LNH

Sunset Deluxe Nasal CPAP Masks

Mask with Headgear and Replaceable Cushion

Size	Item#
Small	CM006S
Medium	CM006M
Large	CM006L

Same features as the full face with 360° dual-swivel elbow port, quick release clips, and ultra-lightweight replaceable cushions.

HG003 Headgear - Fits Most
HG003XL Headgear - XL

CMSIZE01
Deluxe Sizing Guide

HCPCS#
MASK - A7034
HEADGEAR - A7035
CUSHION - A7032



Replacement Cushions

Size	Item#
Small	CUCM006S
Medium	CUCM006M
Large	CUCM006L

Mask with Headgear, Adjustable Forehead T, and Replaceable Cushion

Size	Item#
Small	CM106S
Medium	CM106M
Large	CM106L



Mask without Headgear

Size	Item#
Small	CM006SNH
Medium	CM006MNH
Large	CM006LNH

SUNSET HEALTHCARE SOLUTIONS

Sunset Deluxe Nasal Pillow CPAP Mask

Item#

CM036

Mask with Headgear and Small, Medium, and Large Pillows

HG036

Headgear Only

HCPCS#

MASK - A7034

HEADGEAR - A7035

PILLOWS - A7033



Replacement Pillows

Size	Item#
Small	CM036SP
Medium	CM036MP
Large	CM036LP



Mask without Headgear

CM036NH

- Easy to fit, assemble, and maintain
- Three different pillow sizes to fit more people more easily
- 360° rotational elbow with flexible silicone tube
- Quiet vent design

Mask Series	Mask Type	Replaceable Cushion	Forehead Support	Flex Tube Included	Headgear Included
CM005	Full Face	✓		✓	✓
CM105	Full Face	✓	✓ (Adjustable)		✓
CM006	Nasal	✓	✓	✓	✓
CM106	Nasal	✓	✓ (Adjustable)		✓
CM007	Full Face				✓
CM008	Nasal				✓
CM110	Nasal	✓			✓
CM036	Nasal Pillow	✓		✓	✓

Sunset Clearsight Deluxe Nasal Mask

Mask with Headgear and Replaceable Cushion

Size	Item#
Small	CM110S
Medium	CM110M
Large	CM110L

HG003 Headgear - Fits Most

HG003XL Headgear - XL

Replacement Cushions

Size	Item#
Small	CUCM110S
Medium	CUCM110M
Large	CUCM110L

HCPCS#
MASK - A7034
HEADGEAR - A7035



- Clearsight design provides unobstructed view

Sunset Classic Full Face CPAP Mask

Mask with Headgear

Size	Item#
Small	CM007S
Medium	CM007M
Large	CM007L
Extra Large	CM007XL

HG003 Headgear - Fits Most

HG003XL Headgear - XL

CMSIZE02

Classic Sizing Guide



HCPCS#
MASK - A7030
HEADGEAR - A7035

- Conventional forehead pad removed to create a clear line of sight
- Minimalist design and ultra-lightweight silicone
- Quick-release clips make it easy to remove
- 360° dual-swivel elbow port allows for free movement
- One-piece mask and cushion design is durable and easy

Sunset Classic Nasal CPAP Mask

Mask with Headgear

Size	Item#
Medium	CM008M
Large	CM008L

HG003 Headgear - Fits Most

HG003XL Headgear - XL

CMSIZE02

Classic Sizing Guide

HCPCS#
MASK - A7034
HEADGEAR - A7035



- Great value for cash patients or those with lower insurance reimbursement
- Headgear clips allow for quick removal of mask — no further adjustments required after initial fitting
- One-piece mask and cushion design is durable and easy

SLEEPNET

Phantom®2 and iQ®2

Phantom®2

Item#
CM050



Replacement Cushion
CUCM050

iQ®2

Item#
CM049



Replacement Cushion
CUCM049

Replacement Frame/Tubing Assembly
CM051

Ask us about our
30-day mask guarantee

- Sleepnet's patented AIR°gel® technology provides maximum comfort while minimizing skin irritation and pressure points on the nasal bridge. Unlike many other gel masks, the unique qualities of AIR°gel® allow the mask to seal with minimal tension. By design AIR°gel® is twice as soft as competing gel products.
- Sleepnet has the only mask that you can shape to each individual face. Flex, Fit, Forget!
- Cushions may be removed and replaced without purchasing a new mask.
- Magnetic Clips — Easy on and off!
- 360° Swivel — Less tube drag for active sleepers.
- One size cushion — Larger fitting range.



Visit www.sunsethcs.com

SUNSET
HEALTHCARE SOLUTIONS

Innova

Nasal Mask with Headgear

Size	Item#
Small/Medium	CM034SM
Medium/Large	CM034ML

HCPCS#
MASK - A7034
HEADGEAR - A7035

Full Face Mask with Headgear

Size	Item#
Small	CM035S
Medium	CM035M
Large	CM035L

HCPCS#
MASK - A7030
HEADGEAR - A7035



Innova® CPAP masks feature patented AIR^ogel with Advanced Cushion Technology and Active Headgear Connector™. Together, they provide an optimal fit, maximum comfort, and freedom.

- The Touchless Spacebar's unique design eliminates any contact with the patient's forehead
- The quick-release headgear is lightweight, breathable, and slides off easily with one hand
- Made in the USA

MiniMe Pediatric Nasal Mask

Mask with Headgear

Headgear Size	Item#	OEM#
Small	CM004S	60213
Medium	CM004M	60214
Large	CM004L	60215



Replacement Headgear

Size	Item#	OEM#
Small	HG010S	55241
Medium	HG010M	55242
Large	HG010L	55243

HCPCS#
MASK - A7034
HEADGEAR - A7035

- Non-vented version available

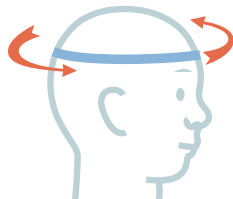

MASK SIZE	HEAD CIRCUMFERENCE
SMALL	14-16in
MEDIUM	17-18in
LARGE	19-21in

Measure around head above eyebrows for head circumference

MiniMe 2 Pediatric Nasal Mask

Mask with Headgear

Size	Item#	OEM#
Extra Small	CM027XS	60216
Small	CM027S	60217
Medium	CM027M	60218
Large	CM027L	60221



Replacement Headgear

Size	Item#
Extra Small/Small	HG027S
Medium/Large	HG027L

HCPCS#
MASK - A7034
HEADGEAR - A7035

- Non-vented version available



Ascend

Nasal Mask with Headgear and All Cushions

Item# **CM037N**

Replacement Cushions

Size	Item#
Small	CM037NCS
Medium	CM037NCM
Large	CM037NCL

Nasal Mask with Headgear and 1 Cushion

Size	Item#
Small	CM037NS
Medium	CM037NM
Large	CM037NL

HCPCS#
MASK - A7034
HEADGEAR - A7035
CUSHION - A7032

Full Face Mask with Headgear and All Cushions

Item# **CM037F**

Replacement Cushions

Size	Item#
Small	CM037CS
Medium	CM037CM
Large	CM037CL

Full Face Mask with Headgear and 1 Cushion

Size	Item#
Small	CM037S
Medium	CM037M
Large	CM037L

HCPCS#
MASK - A7030
HEADGEAR - A7035
CUSHION - A7031

- One frame with three sizes of replaceable cushions: S, M, L
- Unique flexible spacebar design provides superior stability, holding a seal without contacting the skin
- Sleepnet's patented AIR^ogel minimizes pressure points and skin irritation while offering maximum comfort with minimum weight
- Lightweight, breathable quick-release headgear slides off easily with one hand
- 360-degree rotating elbow for optimal tube positioning and easier mobility
- Active Headgear Connector moves as the patient moves for a reliable seal
- Made in the USA

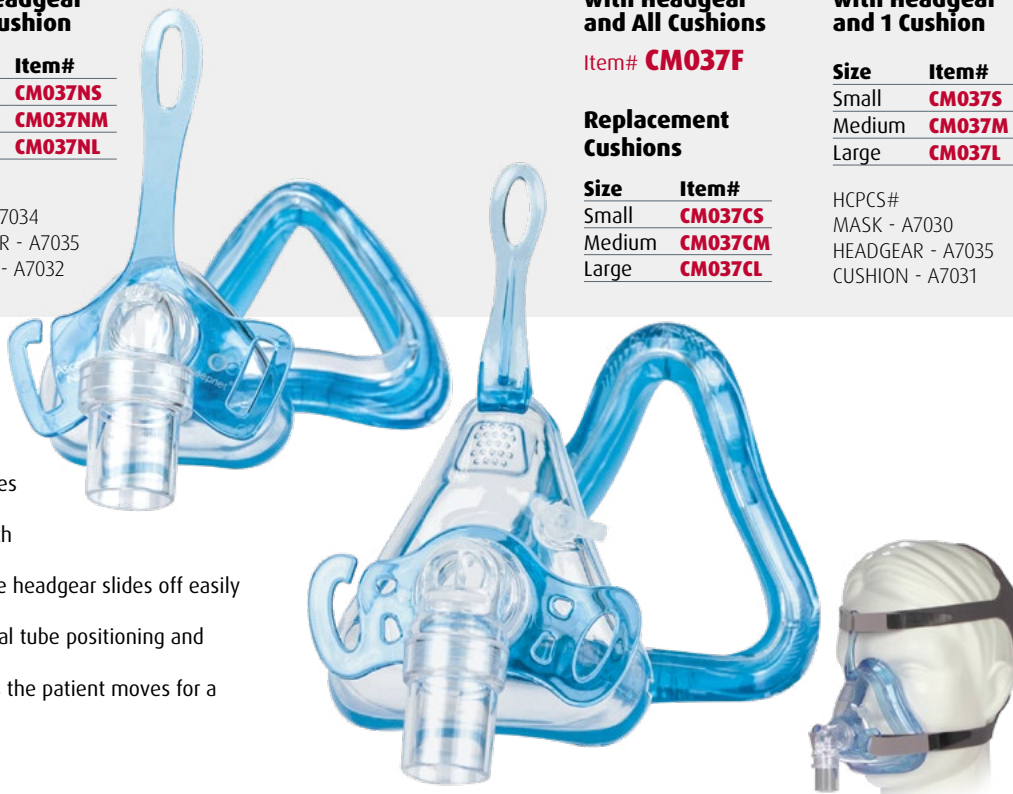

iQ Nasal Mask

Item# **CM001**

iQ Nasal Mask with Headgear

OEM# TMS-889

HCPCS#
MASK - A7034
HEADGEAR - A7035



Mojo 2 Full Face Mask

Mask with Headgear

Size	Item#	OEM#
Small	CM50817	50817
Medium	CM50818	50818
Large	CM50819	50819
Extra Large	CM50820	50820

- Maximum comfort, minimum weight. Patented AIR^ogel minimizes pressure points and skin irritation
- Forehead adjustment screw removes pressure from the bridge of the nose for personalized fit
- The shapeable shell of each mask can be easily molded to fit individual needs: bend it, mold it, shape it!
- Lightweight, breathable headgear disconnects from mask easily with one hand thanks to the quick-release magnetic headgear clips
- Oxygen port allows easy delivery of supplemental oxygen
- 360° rotating elbow for optimal tube positioning and easier mobility



Mojo Full Face Mask

Mask with Headgear

Size	Item#	OEM#
Small	CM003SH	TMS-835
Medium	CM003MH	TMS-836
Large	CM003LH	TMS-837

Replacement Headgear

HG003
OEM# TMS-89

HCPCS#
MASK - A7030
HEADGEAR - A7035



Visit www.sunsethcs.com

CIRCADIANCE

SleepWeaver® Advance Nasal Mask



Blue

- One size fits most (Small Tan available for smaller faces)
- Includes Advance headgear that can be adjusted to fit a broader range of patients



Leopard



Camo



Pink



Tan

Mask with Adjustable Headgear

Mask Color	Item#	OEM#
Blue	CM017B	100274
Camo	CM017C	100281
Leopard	CM017L	100285
Pink	CM017P	100277
Tan	CM017T	100332

CM017T-S
Small Tan
OEM# 101224

HCPCS#
MASK - A7034
HEADGEAR - A7035

HG017
Headgear Only
OEM# 100435

CM017TNH
Tan — No Headgear
OEM# 100336

- Easy to store and pack for travel

SleepWeaver® Élan Nasal Mask

Mask Kit

Mask Color	Item#	OEM#
Tan	CM022T-KIT	100563
Blue	CM022B-KIT	100782

Kits Include:

- Mask
- Small Cushion
- Regular Cushion
- Large Cushion
- Headgear
- Feather Weight Tube®
- Overhead Tube Tether Strap
- Quick Start Illustration Guide
- Instructional DVD

HCPCS#
MASK - A7034
HEADGEAR - A7035
TUBE - A7037

TUB0018F
Replacement
Feather Weight Tube®
OEM# 100477

HG022
Headgear Only
OEM# 100630

Mask with Headgear only

Size and Color	Item#	OEM#
Small Blue	CM022B-S	100728
Regular Blue	CM022B-R	100519
Large Blue	CM022B-L	100482
Small Tan	CM022T-S	100727
Regular Tan	CM022T-R	100518
Large Tan	CM022T-L	100481

All SleepWeaver Masks

- Made of soft cloth
- Allow sleeping on side, stomach, and even wearing glasses
- Easy to store and pack for travel
- Hand or machine washable gentle cycle, mild detergent, hang to dry

Replacement Cushions

Size and Color	Item#	OEM#
Small Blue	CUCM022B-S	100743
Regular Blue	CUCM022B-R	100654
Large Blue	CUCM022B-L	100664
Small Tan	CUCM022T-S	100742
Regular Tan	CUCM022T-R	100653
Large Tan	CUCM022T-L	100663
Small Leopard	CUCM022L-S	100746
Reg. Leopard	CUCM022L-R	100657
Large Leopard	CUCM022L-L	100667



- Detachable 90° elbow with 360° rotation allows for over-the-head hose placement

SleepWeaver® Anew™ Full Face Mask

Blue Mask with Headgear

Size	Item#	OEM#
Small	CM026B-S	100955
Regular	CM026B-R	100960
Large	CM026B-L	100965

Headgear

Size	Item#	OEM#
Small	HGCM026-S	101145
Reg/Lg	HGCM026-R	101084

TUB0018F

Feather Weight Tube®
OEM# 100477

HCPCS#
MASK - A7027
HEADGEAR - A7035
TUBE - A7037

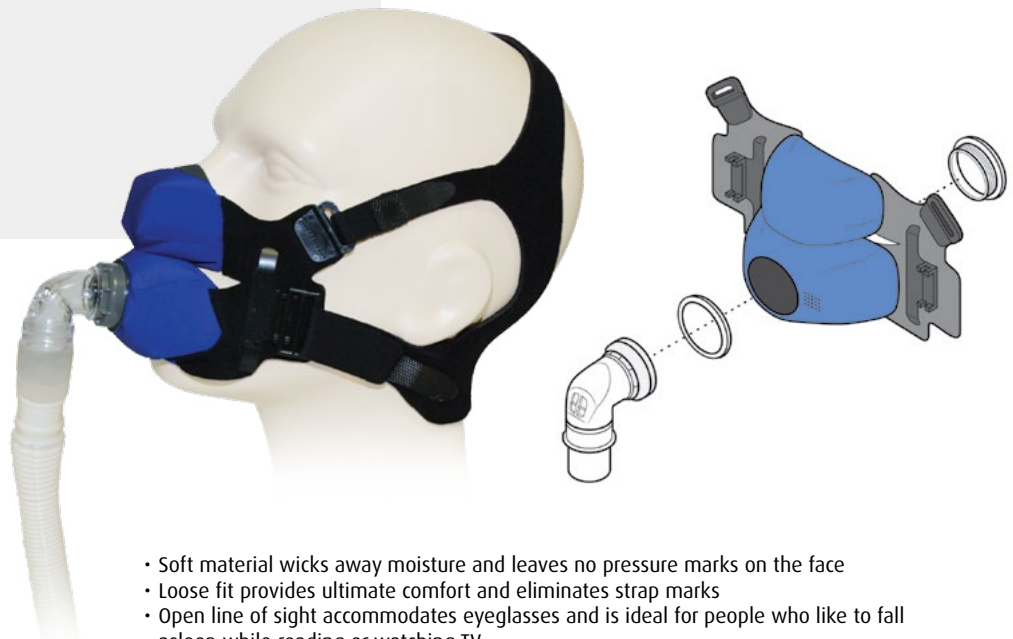

- Soft material wicks away moisture and leaves no pressure marks on the face
- Loose fit provides ultimate comfort and eliminates strap marks
- Open line of sight accommodates eyeglasses and is ideal for people who like to fall asleep while reading or watching TV
- 90° elbow swivel connector rotates 360° allowing users to sleep in more natural positions; easy to remove and clean

Pediatric SleepWeaver® CPAP Mask

Item#
CM101325



The launch of the SleepWeaver Advance Pediatric Soft Cloth CPAP Mask marks the development of a revolutionary interface for CPAP use in pediatric patients. This new configuration extends the range of SleepWeaver products to include pediatric users with delicate facial features.



- Same proven cloth technology enhanced to accommodate children 2 through 7 years of age

SleepWeaver® 3D®

Item#
CM027

Blue Mask without Headgear

Headgear	Item#
With Large Headgear	CM027-LB
With Regular Headgear	CM027-RB

100/packs

Headgear	Item#
With Large Headgear	CM027-L-100
With Regular Headgear	CM027-R-100



- New wing-shaped stay routes the headgear under the ears, ensuring comfort and a great fit
- Permanent 360° swivel provides reliable performance in any position, including over the headboard
- Breathable cloth design eliminates fogging that is common in hard plastic masks - nothing breathes like cloth, keeping skin dry and comfortable
- For those who want to read or watch TV while in bed, SleepWeaver 3D can be worn with glasses
- Users prefer a soft cloth against the face over rubber, silicone and other gels. Cloth masks eliminate the need for a cushion or nasal pad

Aloha® Nasal Pillows System

Item#
CM014

All Sizes Kit
OEM# ALO100

Replacement Headgear

HG014
Aloha Headgear
OEM# ALO130

Replacement Pillows

Size	Item#	OEM#
Small	CM014SP	ALO121
Medium	CM014MP	ALO123
Large	CM014LP	ALO125



Frame

Size	Item#	OEM#
Small	CM014FS	ALO131
Medium	CM014FM	ALO133
Large	CM014FL	ALO135

HCPCS#
MASK - A7034
HEADGEAR - A7035
PILLOWS - A7033

- One of the highest consumer-rated CPAP masks on the market
- Limited headgear reduces points of contact on the face and prevents interference with the eyes
- Removable micro-fleece headgear wraps are included for comfort
- Pillow angle can be adjusted for a more customized and natural fit

AIRWAY MANAGEMENT

Tap Pap

No headgear needed!

Item#
CM024NH

Mask Kit with Small, Medium, and Large Pillows
OEM# PAP-NP1-000

Replacement Pillows

Size	Item#	OEM#
Small	CUCM024S	PAP-NP1-101
Medium	CUCM024M	PAP-NP1-102
Large	CUCM024L	PAP-NP1-103

CM024MP Replacement Mouthpiece
OEM# PAP-NP1-201

HCPCS#
MASK - A7034
PILLOWS - A7033
HEADGEAR - A7035



- Mouthpiece molds to the upper teeth to provide a custom and secure fit even if the bottom teeth are not in contact with the mouthpiece
- Unique nut and bolt joint allows the nasal pillows to be set to the desired angle
- Provides a stable fit regardless of the sleep position
- Patients report not being able to feel the mask on their face
- 3 sizes of nasal pillows included (Small, Medium, and Large)
- 90-day compliance guarantee for new users of the mask, 30-day guarantee for experienced users

AIRWAY MANAGEMENT

myTAP



Item# **CM039**



Precision-fit, immediate, simple and affordable solution for snoring and mild to moderate sleep apnea.

- Offers immediate treatment
- Can be fitted in 15 minutes in a sleep lab, physician's office or HME
- Clinically proven in over 40 independent peer reviewed studies to treat snoring and obstructive sleep apnea (OSA)
- Patients control and remold trays with Precision-Fit, enabling overall comfort, compliance and success: 90% of patients achieve ideal fit upon first try, no bite registration needed
- Thin, sleek trays create a comfortable, low-profile appliance
- Simple design makes it an affordable and convenient option
- Includes an AM Aligner to help offset potential bite changes
- Includes a mouth shield accessory to prevent dry mouth or excess saliva. A secondary benefit is the promotion of nasal breathing, the best natural way to breathe

AIRAVANT

Bongo Rx EPAP

Item# **CAPBNG500**

Bongo Rx all sizes starter kit

- All four sizes: small, medium, large, and extra large
- Travel case
- Drying stand
- Headgear
- No machine, tube, electricity, or batteries needed
- Use at home, traveling, camping... use anytime, anywhere
- Small enough to fit in a shirt pocket
- Reusable and easy to clean with simply soap and water
- Designed, molded, and assembled in the USA
- Clinically tested to demonstrate safety and effectiveness
- Supplemental lifestyle option for your compliant patients
- Patient friendly option for your non-compliant patients



The Bongo Rx is a simple device with soft nasal seals and is available in various sizes (S, M, L, and XL). The Bongo Rx is an EPAP (expiratory positive airway pressure) device and works as follows:

- During inhalation, small valves open to allow normal breathing through the device.
- During exhalation, the valves close and direct exhaled air through small vents to generate EPAP, which keeps the airway open.

Annual Replenishment Pack

Includes 4 pairs, travel case, drying stand, and headgear

Size	Item#
Small	CAPBNG502
Medium	CAPBNG503
Large	CAPBNG504
Extra Large	CAPBNG505



Single Replenishment Unit

Includes 1 pair and headgear

Size	Item#
Small	CAPBNG512
Medium	CAPBNG513
Large	CAPBNG514
Extra Large	CAPBNG515



CPAP TUBING

Durable CPAP Tubing — Gray



Item#
TUB06
6ft
19mm with 22mm cuffs
HCPCS# A7037

- Sunset's most popular item
- Compatible with nearly all CPAP, BiPAP and BiLevel systems for every manufacturer on the market
- Smooth interior and a corrugated exterior for excellent flexibility and unrestricted interior flow characteristics
- Injection molded cuffs to reduce tearing
- Low memory to avoid kinks
- BPA-free and latex-free

All Lengths

TUB0018	18in
TUB002	2ft
TUB004	4ft
TUB06	6ft
TUB006.5	6ft 6in — Compatible with ResMed tube wraps
TUB007	7ft
TUB008	8ft
TUB010	10ft

Compatible with Sunset's new quick release connector!

Item#
CAP1016

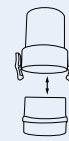

Slim CPAP Tube

Item#
TUB006SS
6ft x 15mm with
22mm cuffs
HCPCS# A7037



- Highly durable**
Strain relief cuff decreases separation and tearing
- Virtually no memory**
Designed to be the most flexible tube available
- Minimal weight**
One of the lightest tubes on the market at 2.6 ounces
- Great value**
Affordable and sustainable

Pressure Port Tubing

Item# **TUB006PP**
6ft with
Pressure Sensor Lines
22mm Cuffs
HCPCS# A7037

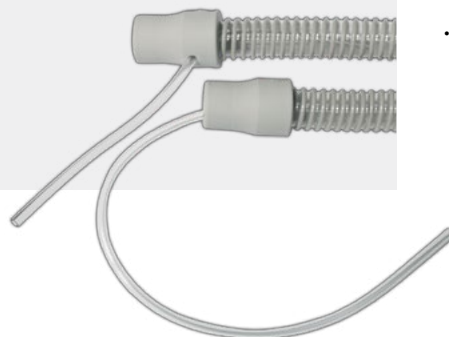

- Built-in sensor line for use with the Puritan Bennett: GoodKnight 420S, 420E and 425 and KnightStar 330

HEATED CPAP TUBING

Heated Tube for Respiration

Item#

TUB06HPR

Heated Tube for
Philips Respiration
Dreamstation Series
and System One

OEM# HT15
HCPCS# A4604

- 510(k)
- UL Recognized
- Strain relief cuffs
- Auto safety shut-off

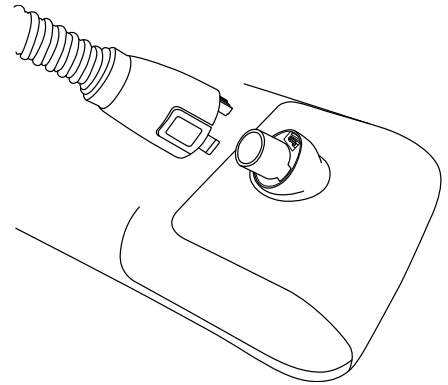

TUBHC900ICON208

Heated Tube for Fisher & Paykel ICON

OEM# 900ICON208

Hybernite Heated CPAP Tube 6ft

Item#

TUB006ROC *MOQ applies*

- Copper wire embedded in the tubing wall generates uniform heat and maintains the air temperature inside the tube to prevent rainout
- Stand-alone kit can be used in the sleep lab or at home with any CPAP or BIPAP machine with humidifier
- Includes heated circuit tube and independent power supply

Compatible with machines that use standard CPAP Tubing.
Not compatible with machines that use slim 15mm tubing
such as newer Respiration and ResMed machines.



TUB006HBT

Hybernite Replacement Heated CPAP Tube 6ft

DreamStation 2



Item# **CF1012**
 Disposable Filter
6/pack
 OEM# 1142831
 HCPCS# A7038
CF1012-1 1/pack OEM# 1142828
CF1012-2 2/pack OEM# 1142829
CF1012-3 3/pack
CF1012-50 50/pack

Item# **CF1012F**
 Reusable Filter
2/pack
 OEM# 1142687
 HCPCS# A7039
CF1012F-1 1/pack

DreamStation



Item# **CF1010**
 Disposable Filter
6/pack
 OEM# 1122519
 HCPCS# A7038
CF1010-1 1/pack
CF1010-2 2/pack

Item# **CF1010F**
 Reusable Filter
2/pack
 OEM# 112446 (1-pack)
 HCPCS# A7039
CF1010F-1 1/pack
CF1010F-6 6/pack

M-Series



Item# **CF1007**
 Ultrafine Filter - Tabbed
6/pack • 1³/₄" x 7⁷/₈"
 HCPCS# A7038
CF1007-1 1/pack
CF1007-2 2/pack

Item# **CF1007F**
 Foam Filter
2/pack • 1⁵/₈" x 7⁷/₈"
 OEM# 1029330
 HCPCS# A7039
CF1007F-1 1/pack

PR System One



Item# **CF1009NT**
 Ultrafine Filter - No Tab
6/pack • 1³/₄" x 7⁷/₈"
 OEM# 1029331
 HCPCS# A7038
CF1009NT-1 1/pack
CF1009NT-2 2/pack

Item# **CF1009**
 Ultrafine Filter - Tabbed
6/pack • 1³/₄" x 7⁷/₈"
 HCPCS# A7038
CF1009-1 1/pack
CF1009-2 2/pack

Item# **CF1009F**
 Foam Filter
2/pack • 1⁵/₈" x 7⁷/₈"
 OEM# 1029330
 HCPCS# A7039
CF1009F-1 1/pack

REMstar Pro, REMstar Plus



Item# **CF1006**
Ultrafine Filter
2/pack • 3¹/₂" x 1¹/₂"
OEM# 1005945
HCPCS# A7038

Item# **CF1006F**
Foam Filter
2/pack • 3⁵/₈" x 1⁵/₈"
OEM# 1005964
HCPCS# A7039

BiPAP Pro, Plus, Duet LX, Synchrony



Item# **CF1005**
Ultrafine Filter
6/pack • 4³/₄" x 3¹/₄"
OEM# 622219
HCPCS# A7038

Item# **CF1005F**
Foam Filter
2/pack • 4³/₄" x 2³/₈"
OEM# 622220
HCPCS# A7039

Aria, Virtuoso, Duet, Quartet



Item# **CF1004**
Ultrafine Filter
6/pack • 3¹/₂" x 2³/₁₆"
OEM# 532311
HCPCS# A7038

Item# **CF1004F**
Foam Filter
2/pack • 3¹/₄" x 2¹/₈"
OEM# 532247
HCPCS# A7039

REMstar



Item# **CF1003**
Ultrafine Filter
6/pack • 5¹/₂" x 4³/₄"
OEM# 362522
HCPCS# A7038

Item# **CF1003F**
Foam Filter
1/pack • 5³/₄" x 5¹/₄"
OEM# 362521
HCPCS# A7039

Solo, Aria LX, Virtuoso LX, REMstar LX



Item# **CF1002**
Ultrafine Filter
6/pack • 3³/₈" x 2³/₄"
OEM# 622017
HCPCS# A7038

Item# **CF1002F**
Foam Filter
2/pack • 3⁵/₁₆" x 2⁵/₁₆"
OEM# 622018
HCPCS# A7039

SleepEasy/BiPAP



Item# **CF1001**
Ultrafine Filter
6/pack • 7³/₄" x 4⁷/₈"
OEM# 302064
HCPCS# A7038

*All filters can be ordered in any pack quantity.
Contact your sales rep for details.*

AirSense 11



Item#
CF2111
 Disposable Filter
3/pack
 HCPCS# A7038
CF2111-1 1/pack OEM# 39300
CF2111-2 2/pack OEM# 39301
CF2111-50 50/pack OEM# 39303

Item#
CF2111HA-3
 Hypoallergenic Filter
3/pack
 1¹/₄" x 1³/₁₆"
 HCPCS# A7038
CF2111HA-1 1/pack
CF2111HA-2 2/pack

S9 and AirSense 10 Series



Item#
CF2107
 Disposable Filter
3/pack • 2¹/₈" x 1³/₈"
 HCPCS# A7038
CF2107-1 1/pack OEM# 36850
CF2107-2 2/pack OEM# 36851
CF2107-50 50/pack OEM# 36853

Item#
CF2107HA
 Hypoallergenic Filter
3/pack • 2¹/₈" x 1³/₈"
 HCPCS# A7038
CF2107HA-1 1/pack OEM# 36855
CF2107HA-2 2/pack OEM# 36856
CF2107HA-50 50/pack
 OEM# 36858

AirMini



Item#
CF2108
 Disposable Filter
2/pack • 1¹/₄" x 1³/₁₆"
 OEM# 38815
 HCPCS# A7038

Adapt SV



Item#
CF2106
 Disposable Filter
3/pack • 1¹/₄" x 1¹/₂"
 OEM# 26926
 HCPCS# A7038

Item#
CF2106HA
 Hypoallergenic Filter
3/pack • 1¹/₄" x 1¹/₂"
 OEM# 26927
 HCPCS# A7038

S8 Series

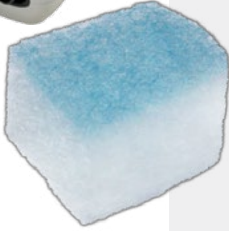

Item#
CF2105
Disposable Filter
3/pack • 1³/₈" x 1³/₈"
OEM# 33916
HCPCS# A7038

CF2105-1 1/pack OEM# 33915
CF2105-2 2/pack OEM# 33973
CF2105-50 50/pack OEM# 33918



Item#
CF2105HA
Hypoallergenic Filter
3/pack • 1³/₈" x 1³/₈"
OEM# 33920
HCPCS# A7038

CF2105HA-1 1/pack OEM# 33919
CF2105HA-2 2/pack OEM# 33975
CF2105HA-50 50/pack OEM# 33922

S7 Series



Item#
CF2103
Disposable Filter
3/pack • 1¹/₄" x 1¹/₂"
OEM# 30907
HCPCS# A7038

CF2103-1 1/pack OEM# 30919
CF2103-2 2/pack
CF2103-50 50/pack OEM# 30908



Item#
CF2103HA
Hypoallergenic Filter
3/pack • 1¹/₄" x 1¹/₂"
HCPCS# A7038

CF2103HA-1 1/pack OEM# 30933

S6 Series



Item#
CF2102
Disposable Filter
3/pack • 5³/₄" x 5⁵/₈"
OEM# 21935
HCPCS# A7038

CF2102-50 50/pack
OEM# 21936

FISHER & PAYKEL

SleepStyle Series



Item#
CF4004-2
Disposable Filter
2/pack
HCPCS# A7038



ICON Series



Item#
CF4003
Disposable Filter
4/pack
2 1/16" x 5/8"
HCPCS# A7038



CF4003-1 1/pack
OEM# 900ICON503

CF4003-6 6/pack
OEM# 900ICON212

HC230 Series, HC600 Series



Item#
CF4002
Disposable Filter
4/pack • 2 3/4" x 7/8"
OEM# 900HC240
HCPCS# A7038
CF4002-2 2/pack

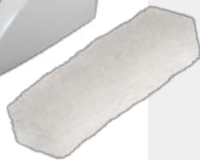

HC200, HC220, HC221



Item#
CF4001
Disposable Filter
4/pack • 5" x 3/4"
OEM# 900HC222
HCPCS# A7038
CF4001-2 2/pack



3B

Luna G3



Item# **CF8006-6**
Disposable Filter
6/pack
HCPCS# A7038
CF8006-1 1/pack
CF8006-2 2/pack

Item# **CF8006F-1**
Reusable Filter
1/pack
HCPCS# A7039

Luna and Luna II



Item#
CF8005
Disposable Filter
12/pack • 2" x 1 3/16"
HCPCS# A7038

Item#
CF8005F-1
Reusable Filter
1/pack • 2" x 1 3/16"
HCPCS# A7039
CF8005F-2 2/pack

RESmart



Item#
CF8004
Disposable Filter
3/pack • 3 5/16" x 1 5/8"
HCPCS# A7038

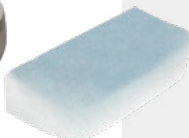

AEIOMED

Everest Aura, Everest III and Integrated

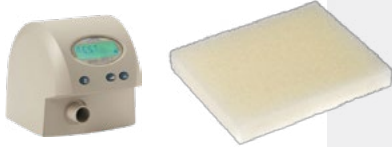

Item#
CF8001
Foam Filter
2/pack • 2" x 1⁹/₁₆"
OEM# 100446
HCPCS# A7039

BEYOND

ResPlus



Item#
CF9005F-2
Reusable Filter
2/pack
HCPCS# A7039
CF9005F-1 1/pack

BREAS/GE

iSleep 20 Series



Item# **CF7003**
Ultrafine Filter
2/pack • 2¹/₄" x 7⁷/₈"
OEM# 004153
HCPCS# A7038

Item# **CF7003F**
Foam Filter
Each • 2³/₄" x 1"
OEM# 004154
HCPCS# A7039

PV10



Item# **CF7002**
Ultrafine Filter
2/pack • 2³/₄" x 7⁷/₈"
OEM# 2B01975
HCPCS# A7038

Item# **CF7002F**
Foam Filter
Each • 2⁵/₈" x 7⁷/₈"
OEM# 2B01972
HCPCS# A7039

PV1



Item# **CF7001-10**
Ultrafine Filter
10/pack • 2¹/₂" x 1¹/₄"
HCPCS# A7038

Item# **CF7001F**
Foam Filter
3/pack • 2¹/₂" x 1¹/₄"
HCPCS# A7039

CAREFUSION/VIASYS

PureSom



Item#
CF9003
Ultrafine Filter
3/pack • 1³/₁₆" x 1⁷/₁₆"
OEM# 7511
HCPCS# A7038

Item#
CF9003F
Foam Filter
3/pack • 1³/₁₆" x 1⁷/₁₆"
OEM# 7510
HCPCS# A7039

Orion and Pegasus



Item#
CF8002
Ultrafine Filter
6/pack • 2⁷/₈" x 1³/₄"
OEM# 774688
HCPCS# A7038

Item#
CF8002F
Foam Filter
Each • 2⁷/₈" x 1³/₄"
OEM# 774689
HCPCS# A7039

COVIDIEN NELLCOR PURITAN BENNETT

GoodKnight 314/318



Item#
CF6005F
Foam Filter
2/pack • 6¹/₄" x 1"

OEM# S-290609-00
HCPCS# A7039

GoodKnight 420/425



Item#
CF6003
Ultrafine Filter
2/pack • 1³/₁₆" x 3¹/₁₆"
OEM# M-413950-04
HCPCS# A7038

Item#
CF6003F
Foam Filter
Each • 1³/₁₆" x 3¹/₁₆"
OEM# M-413950-02
HCPCS# A7039

GoodKnight 418 A/G/P/S



Item#
CF6002
Ultrafine Filter
4/pack • 5³/₁₆" x 3⁴/₄"
OEM# Y-413560-01
HCPCS# A7038

GoodKnight 418



Item#
CF6001
Ultrafine Filter
4/pack • 2¹/₄" x 1²/₅"
OEM# S-645030-00
HCPCS# A7038

Item#
CF6001F
Foam Filter
6/pack • 2⁷/₁₆" x 1¹/₂"
OEM# S-645029-00
HCPCS# A7039

DEVILBISS

IntelliPAP



Item#
CF5004
Ultrafine Filter
4/pack • 1³/₄" x 1¹/₄"
OEM# DV51D-603
HCPCS# A7038

Item#
CF5004F
Foam Filter
4/pack • 1⁵/₈" x 1³/₁₆"
OEM# DV51D-602
HCPCS# A7039

Horizon LT



Item#
CF5003
Ultrafine Filter
4/pack • 4¹/₄" x 1⁵/₁₆"
OEM# 8000D-603
HCPCS# A7038

Item#
CF5003F
Foam Filter
4/pack • 4¹/₄" x 1⁵/₁₆"
OEM# 8000D-602
HCPCS# A7039

EVO MEDICAL

RemRest



Item#
CF8003F
Foam Filter
3/pack • 2³/₁₆" x 1¹/₁₆"
OEM# 21117
HCPCS# A7039

Comfort PAP



Item#
CF9003
Ultrafine Filter
3/pack • 1³/₁₆" x 1⁷/₁₆"
OEM# 7511
HCPCS# A7038

Item#
CF9003F
Foam Filter
3/pack • 1³/₈" x 1¹/₄"
OEM# 7510
HCPCS# A7039

Enhance your branding!

FREE PRIVATE LABELING

Sunset's free service allows you to put your logo and contact information on our products.

Increase brand awareness and allow patients to easily contact you.

Work with our marketing team to customize the layout with your logo, phone number, website address, and reorder information.

Available on all CPAP tubes and filters.
Minimum orders apply.
Certain restrictions may apply.
Contact your sales rep for details.



Visit www.sunsethcs.com



HEALTHDYNE

Quest



Item# **CF3003**
Ultrafine Filter
with Curves
5/pack • 4 1/2" x 4 3/8"
OEM# 7302
HCPCS# A7038

Item# **CF3003F**
Foam Filter
with Curves
5/pack • 4 1/2" x 4 1/4"
OEM# 7301
HCPCS# A7039

Tranquility



Item# **CF3001**
Ultrafine Filter
5/pack • 5 1/8" x 1 7/8"
OEM# 7170
HCPCS# A7038

LÖWENSTEIN

prisma



Item# **VF008-12**
Disposable Filter
12/pack
OEM# WM29652

Item# **VF008F-2**
Reusable Filter
2/pack
OEM# WM29928

RESVENT

iBreeze



Ultrafine Filter
CF9901-1 1/pack
CF9901-2 2/pack
CF9901-6 6/pack
CF9901-50 50/pack
HCPCS# A7038

INVACARE

Polaris LT



Item# **CF9002**
Ultrafine Filter
3/pack • 5" x 2"
OEM# 1082428
HCPCS# A7038

Item# **CF9002F**
Foam Filter
3/pack • 5" x 2"
OEM# 1082995
HCPCS# A7039

Polaris EX



Item# **CF9001**
Ultrafine Filter
3/pack • 2 3/16" x 1"
HCPCS# A7038

Item# **CF9001F**
Foam Filter
3/pack • 2 1/4" x 1 1/16"
OEM# 1124211
HCPCS# A7039

Polaris TR

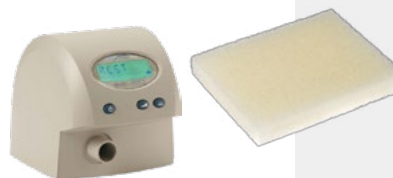

Item# **CF8001**
Foam Filter
2/pack • 2" x 1 9/16"
OEM# 100446
HCPCS# A7039

PROBASICS

Zzz-PAP



Item# **CF9003**
Ultrafine Filter
3/pack • 1 3/16" x 1 7/16"
OEM# 7511
HCPCS# A7038

Item# **CF9003F**
Foam Filter
3/pack • 1 3/16" x 1 7/16"
OEM# 7510
HCPCS# A7039

FISHER & PAYKEL

Humidifier Chamber for ICON Series



Item# **HUMHC900ICON200**

Replacement Chamber for the Fisher & Paykel ICON Series

Each OEM# 900ICON200 • HCPCS# A7046

Compatible with: • ICON Premo
• ICON Novo
• ICON Auto



Humidifier Chambers for HC200 Series



Item# **HUMHC355**

Extended Life Humidifier Chamber for the Fisher & Paykel HC200 Series

Each OEM# HC 355



Item# **HUMHC385**

Replacement Chamber for the Fisher & Paykel SleepStyle HC200 Series

Each OEM# HC 385S

HCPCS# A7046



Compatible with: • HC200 • HC231 • HC236
with: • HC201 • HC232 • HC238
• HC220 • HC233 • HC242
• HC221 • HC234 • HC244
• HC254

Humidifier Chambers for HC100 Series



Item# **HUMHC300**

Extended Life Humidifier Chamber for the Fisher & Paykel HC100 Series

Each OEM# HC 300



Item# **HUMHC325S**

Replacement Chamber for the Fisher & Paykel HC100 Series

Each OEM# HC 325S

HCPCS# A7046

Compatible with: • HC100
• HC105
• HC150



Humidifier Chamber for HC600 Series



Item# **HUMHC365**

Replacement Chamber for the Fisher & Paykel SleepStyle 600 Series

Each OEM# HC 365S • HCPCS# A7046

Compatible with: • HC604
• HC608



RESPIRONICS

Humidifier Chamber for PR System One



Item# **HUM1136502**

Humidifier Chamber for PR System One 60 Series

Each HCPCS# A7046

Humidifier Chamber for DreamStation



Item# **HUM1122520**

Humidifier Chamber for DreamStation

Each HCPCS# A7046

SUNSET CHINSTRAPS

Universal Neoprene Chinstrap



Item# **CS001**
 Universal Chinstrap
 HCPCS# A7036

- Latex-free
- One size fits most
- Attaches to itself at the top of the head
- Can be used with any nasal mask or pillows

Basic Chinstrap



Item# **CS002**
 Compare to Respiration Basic
 OEM# 302175
 HCPCS# A7036

- Latex-free
- One size fits most
- Attaches to the top strap of headgear
- Cups the chin for comfort
- Works best with any nasal mask

Adjustable Neoprene Chinstrap



Size	Item#
6in	CS003S
7in	CS003R
8in	CS003M
9in	CS003L
10in	CS003XL

Compare to Puresom Adjustable Ruby
 OEM# TMS-09 ADJ
 HCPCS# A7036

- Latex-free
- Thin adjustable strap attaches at the top of the head. Thicker bottom strap attaches to itself at the back of the head.
- Great for hard-to-fit patients

For fitting, measure along one side of the head, as indicated by the dashed line above.

Deluxe Chinstrap



Size	Item#
26in	CS004S
28in	CS004L

Compare to Respiration Deluxe
 OEM# 302425
 HCPCS# A7036

- Latex-free
- Attaches to itself at the top of the head, two smaller support straps keep the system in place
- Extra-wide strap distributes pressure to add comfort

Comfort Chinstrap



Item# **CS005**
 Compare to ResMed Sullivan
 OEM# 16015
 HCPCS# A7036

- Latex-free
- One size fits most
- Easy to use—attaches to itself at the top of the head
- Soft cloth chin cup adds comfort

Premium Chinstrap



Item# **CS006**
 Compare to Respiration Premium
 OEM# 1012911
 HCPCS# A7036

- One size fits most
- Attaches to itself at the top of the head to keep the chin lifted. Smaller support strap attaches to a split section of the chinstrap and wraps around the head for added stability.

SUNSET CHINSTRAPS AND HEADGEAR

Ruby Style Chinstrap

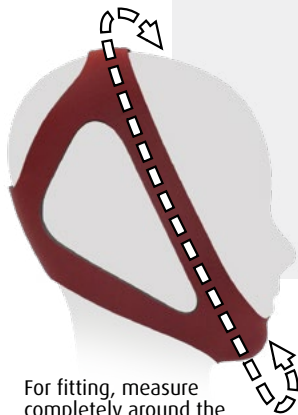

For fitting, measure completely around the head, as indicated by the dashed line above.

Size	Item#
21.5-22.5in	CS007S
22-23in	CS007M
23-24in	CS007L

Compare to Puresom Ruby
OEM# TMS-09 · HCPCS# A7036

- Latex-free
- One piece stretches to slide over the top of the head — no need to Velcro
- Can be used with any nasal mask or pillows

Halo Style Chinstrap



Item# **CS025**
Compare to BreatheWear Halo Chinstrap
OEM# H3407
HCPCS# A7036

Ruby Style Adjustable Chinstrap



Size	Item#
Regular	CS007-ADJ
Extra Large	CS007-ADJXL

HCPCS# A7036

- Latex-free
- Fully adjustable
- Super soft materials for extra comfort



Universal Mesh Headgear

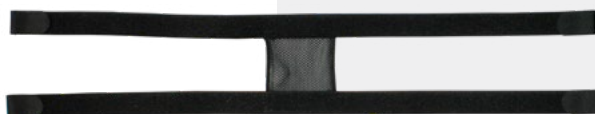

Item# **HG001**
Compare to Respronics SimpleStrap Headgear
OEM# 302328
HCPCS# A7035

- Latex-free
- One size fits most
- Can be used with most 4-point nasal or full face masks

Universal Headgear



Size	Length	Item#
Regular	22.5in	HG003
Extra Large	24.5in	HG003XL

HCPCS# A7035

- Latex-free
- Can be used with most 4-point nasal or full face masks

CLEANERS

Sunset Cleaning Wipes — Flowpack

Item# **CAP1003S**
Flowpack of 64 wipes
12/case



- Ingredients are safe and gentle for daily cleaning of all types of CPAP and oxygen masks and equipment

Private Label CPAP Wipes



Order the flowpack wipes with your logo and contact info on a lid sticker, with a minimum quantity commitment. Talk to your sales rep for more info.

Citrus II Cleaning Wipes

Item# **CAP1003**
Canister of 62 wipes
12/case



CleanSmart CPAP Disinfectant Spray

Item# **CAP1018-L**
16oz • **6/case**

Item# **CAP1018-S**
2oz • **9/case**



- Kills 99.9% of viruses & bacteria
- Included on the EPA's List N: Disinfectants for Use Against SARS-CoV-2
- Active ingredient Hypochlorous Acid does not leave a chemical residue
- EPA Registration Number 89896-2
- Formulated for disinfecting surfaces of external medical equipment and external surfaces of respiratory equipment

Citrus II Mask Cleaning Spray

Item# **CAP1001**
1.5oz • **24/case**

Item# **CAP1002**
8oz • **12/case**

- All-natural cleanser for daily mask cleaning
- Available in 1.5oz travel size or 8oz non-aerosol spray cans



Cleaning Wipes — Single Packs

Item# **CAP1005**
Citrus II Box of 12 single-pack wipes
12/case

- Convenient individually wrapped wipes are great for patient samples or travel use



Filter and Check Valve Kit for SoClean 2 CPAP Cleaning Device

Item# **CAP1007S-KIT**
Each

- With filter, check valve, retail packaging and instruction manual
- Replace every 6 months

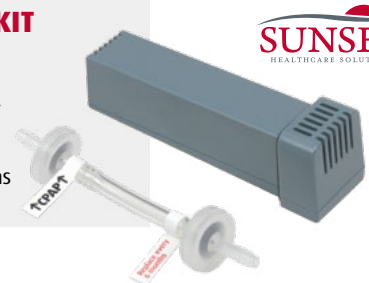

CASH ITEMS

CPAP Tube Cleaning Brush

Item#
CAP1013
Standard 6ft
Each

- Brushes all the way through a 6ft CPAP tube without leaving debris in the middle
- Stainless steel wire and soft nylon bristles

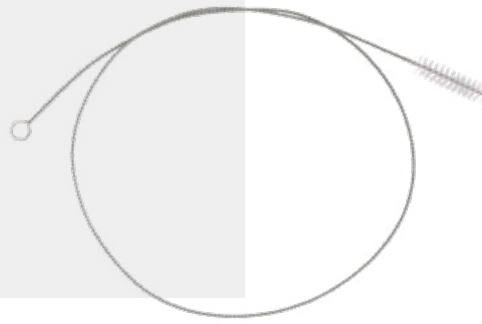

SleepRes V-Com™

Item#
CAP1026
Each



Helping patients adjust to CPAP on their own

Adding V-Com to a patient's therapy is like Training Wheels for CPAP™. This simple device can mean the difference between your patient giving up on PAP or continuing their lifesaving treatment.

Within minutes, a respiratory therapist can show a patient what the PAP pressure feels like with and without the V-Com device inline. This feedback mechanism allows them to better understand how their airflow should feel.

As you know, comfort equals adherence and adherence equals better treatment outcomes.



The V-Com Difference

Improve early PAP tolerance with V-Com by providing your patients with initial comfort without compromising their treatment.

Traditionally, when a patient struggles with the constant flow of air pressure, pressure settings are reduced.

Reducing pressure settings to increase a patient's initial tolerance improves comfort, but at a cost.

Decreasing pressure settings also means decreasing expiratory positive airway pressure (EPAP) which is principally responsible for therapy.

The V-Com effect is flow-dependent with its maximum comforting effect during the high inspiratory flows. As a result, V-Com has minimal effect on expiratory positive airway pressure.

90-Degree CPAP Tubing Elbow

Item#
CAP1027
Each



The Sunset 90-Degree CPAP Tubing Elbow Adapter connects standard 22mm or slim 15mm CPAP tubes to most CPAP machines at a 90-degree angle, relieving stress on the tubing connection and creating a more convenient pathway to the bed.

Comparable to OEM# 37394



CPAP BATTERY

Portable Outlet UPS CPAP Battery

Item#
CAP10082

Includes battery, wall charger, and travel bag

- Autoswitch technology: When power goes out, your CPAP stays on
- Three-prong AC outlet
- Two USB ports
- Digital display
- Convenient travel bag
- Meets TSA/FAA battery guidelines
- 1-year warranty
- Rated for over 500 charge cycles
- Recharges in less than 4 hours
- May be used for other devices powered by AC or USB
- AC and USB ports may be used simultaneously



Specs

- 2.875 lbs
- 5.375 in wide x 9 in long x 1.5 in tall
- Rated Capacity: 159Wh/14.4Ah
- Rated Voltage: 14.5V
- Charge Input: 16.8V/2A
- USB Output: 5V/4.2A
- AC Output: 110v AC 60hz/100w
- AC Adapter Input: 100V-240V/50-60Hz

DC to AC Power Inverter, Car Charger, Lighter Plug-in

Item# **CAPDC2AC150**

Recharge your Portable Outlet CPAP Battery using a car's 12V lighter outlet

- Can also power most CPAPs and other small electronics
- 150 Watts
- 3-prong outlet
- 2 USB ports



CPAP HCPCS AND REPLACEMENT SCHEDULE

HCPCS	Item	Recommended replacement schedule
A4604	Heated Circuit Tubing	1 per 3 months
A7027	Combination Oral/Nasal Mask	1 per 3 months
A7028	Replacement Oral Cushion for Combination Oral/Nasal Mask	2 per month
A7029	Replacement Nasal Pillows for Combination Oral/Nasal Mask — Pair	2 per month
A7030	Full Face Mask	1 per 3 months
A7031	Replacement Full Face Mask Cushion or Liner	1 per month
A7032	Replacement Nasal Cushion or Liner	2 per month
A7033	Replacement Pillows — Pair	2 per month
A7034	Nasal or Pillows Mask	1 per 3 months
A7035	Headgear	1 per 6 months
A7036	Chinstrap	1 per 6 months
A7037	Tubing	1 per 3 months
A7038	Filter — Disposable	2 per month
A7039	Filter — Nondisposable	1 per 6 months
A7044	Oral Interface	
A7045	Replacement Exhalation Port	
A7046	Replacement Water Chamber	1 per 6 months
A9279	Monitoring Feature/Device	
E0470	BiLevel Device without Backup Rate	
E0471	BiLevel Device with Backup Rate	
E0561	Humidifier - Non-Heated	
E0562	Humidifier - Heated	
E0601	CPAP Device	

Due to the rapid changes in reimbursement, this information is for reference only. Sunset Healthcare Solutions cannot guarantee its comprehensiveness or accuracy. Sunset urges you to contact a reimbursement specialist for up-to-date information and advice.

Transcend Micro™ Auto CPAP

Item#
CAPSOM506001
Each



- **Small:** About the size of a baseball
- **Lightweight:** Weighs less than a mobile phone
- **Works with any CPAP mask:** Use your existing mask
- **Quiet operation:** The Transcend WhisperSoft™ muffler is included

- Smallest and lightest travel CPAP device
- Compatible with any CPAP Mask
- Unplug and sleep anywhere with more power options
- Adjustable GentleRise and AirRelief technology
- Stay dry, all the time
- AirMist HME – waterless humidification

Included:

- Transcend Micro CPAP
- Transcend Micro AirFlex™ 6-foot hose
- Transcend WhisperSoft™ Muffler
- AC power adapter
- 2 Year manufacturer's warranty



Transcend Micro™ Accessories

Item#

CAPSOM505001	PowerAway® Battery
CAPSOM503056	Solar Battery Charger
CAPSOM503035	Plug Adapters (AU/EU/UK)
CAPSOM505010	Power Supply
CAPSOM505030	AirMist Starter Pack (2 filters and 1 holder)
CAPSOM505009	AirMist Pack (4 filters and 1 holder)
CAPSOM505014	AirMist 4 Pack
CAPSOM505015	AirMist 8 Pack
CAPSOM505016	AirMist 12 Pack
CAPSOM505008	Travel Bag
CAPSOM505017	PureFresh Filters (2 Pack)
CAPSOM505033	Micro WhisperSoft Muffler
CAPSOM505004	Micro AirFlex 6ft Slim Hose
CAPSOM505007	Filter Cover

Item# **CAPSOM505001** PowerAway® Battery

Extended Run Time

- **Long-Lasting Power:** Offers 2-3 nights or 17.7 hours of run time on a single charge at a pressure setting of 9cm, ensuring restful sleep without frequent recharging.
- **Quick Charge Time:** Recharges in less than 4 hours, so it's ready to go when you are.

Reliability and Safety

- **FAA-Approved:** Cleared for in-flight use, making it an essential for travelers
- **Backup Power:** Provides a permanent backup power source during outages, ensuring uninterrupted sleep therapy.
- **Long Life Span:** Capable of 1,000+ full charge/discharge cycles for long-term reliability.



Item#
CAPSOM505042 Essentials Pack

Included:

- NEW Micro WhisperSoft Muffler and Hose
- (2) Hose Clips
- AirMist Pack (4 filters and 1 holder)
- Travel Power Supply Plug Adapters
- Micro filters (2 pack)
- Transcend Micro Travel Pouch



Item#
CAPSOM505043 Resupply Pack

Included:

- NEW Micro WhisperSoft Muffler & Hose
- AirMist Pack (4 filters and 1 holder)
- Micro filters (2 pack)



CASH ITEMS

Snugz CPAP Mask Liners

Item#
CAP7001

Machine-Washable Liners
for Most Full Face Masks
2/pack

CAP7002

Machine-Washable Liners
for Most Nasal Masks
2/pack



- 2 per pack, 90-day supply
- Machine washable
- Fits MOST nasal or full face CPAP masks (Not recommended for ResMed Mirage Quattro or Respirationics Amara View and Dreamwear)
- Blend of spandex, moisture-wicking polyester and lycra fibers
- Latex-free

Snugz is a machine washable, one-size-fits-most liner for CPAP masks that is designed to help reduce noisy leaks, prevent redness and irritation, and feel great against the skin. The liner helps to grip the skin and keep the mask in place around the nose and mouth, reducing the need for a chinstrap. The improved seal is especially beneficial for high-pressure/high-flow PAP patients and can reduce nightly sleep disturbances and AHI.

Soft Headgear Strap Covers

Item#
CAP2004



- Reduces strap marks
- No bulky and uncomfortable velcro
- Reduces strap irritation on sensitive skin
- Thick padding for extra comfort
- No need for clips – just slip wraps around headgear straps
- Easy and helpful for patients with arthritis in hands or fingers
- Can be machine washed and dried
- Wraps securely grip headgear and slide to adjust
- One size fits all
- Made from 230g Coral Velvet

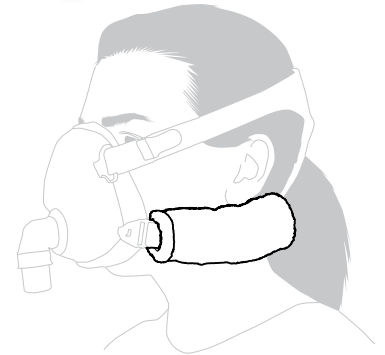

RemZzzs CPAP Mask Liners

Item#

CAP3001(S,M,L)

Liners for Full Face ResMed & Respirationics

OEM#	K1-FS	SMALL
	K2-FM	MEDIUM
	K3-FL	LARGE

CAP3002(S,M,L)

Liners for Full Face Fisher & Paykel, Hans Rudolph, and Sunset HCS

OEM#	K4-FS	SMALL
	K5-FM	MEDIUM
	K6-FL	LARGE

CAP3003(S,M,L)

Liners for Nasal Respirationics

OEM#	K7-NS	SMALL
	K8-NM	MEDIUM
	K9-NL	LARGE

CAP3004(S,M,L)

Liners for Nasal ResMed and Fisher & Paykel

OEM#	K10-NS	SMALL
	K11-NM	MEDIUM
	K12-NL	LARGE

CAP3005L

Liners for Respirationics FitLife Mask

OEM#	6A-FLK	SMALL AND LARGE
	6B-FLK	EXTRA LARGE

CAP3006

Liners for Nasal Pillows

OEM# 7A-NPK

CAP3007

Liners for Respirationics DreamWear and Amara View

OEM# 6C-AVK

30-Day Supply

Boxes sold individually. Full face and nasal mask RemZzzs include 30 facial liners and 2 forehead liners.

- Increases compliance by adding a comfortable and absorbent pad to CPAP mask
- Reduces air leaks and protects skin from red marks



CASH ITEMS

CPAP Moisture Therapy

Item# **CAP6100L**
1oz Tube • 18/case

- Formulated to prevent chafing, irritation, dryness or cracking from using a CPAP mask or other delivery device
- Apply to the face at the beginning of treatment and as needed
- Petroleum-free with aloe vera, vitamins A & E, and argan oil



Pur-Sleep CPAP Aromatherapy

Item# **CAP5001**
VaporClear Aromatherapy Starter Kit
OEM# VAPOR

Kit Includes:

- 1 aluminum diffusion stand
- 4 reusable diffusion pads
- 1.5ml bottle of Clear (peppermint, lime)
- 1.5ml bottle of Calm (eucalyptus, lavender, rosemary)



30ml Aromatic Refills

Scent/OEM#	Item#
Black Cherry	CAP5004-BCH
Calm	CAP5004-CLM
Clear	CAP5004-CLR
Dark Chocolate	CAP5004-DCH
Deep	CAP5004-DEE
French Vanilla	CAP5004-FRV
Fresh	CAP5004-FSH
Peace	CAP5004-PCE
Spice	CAP5004-SPC
Strawberry	CAP5004-STR

Item# **CAP5002**
Reusable Diffusion Pads
10/pack • OEM# DP10

Item# **CAP5003**
Replacement Aluminum Diffusion Tray
Each • OEM# TRAY

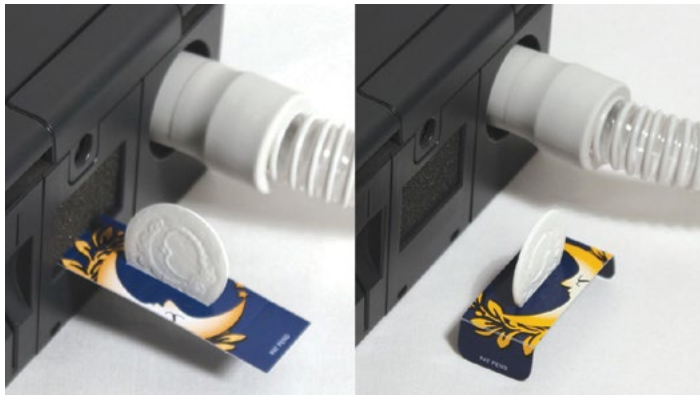

- Aromatherapy products specifically for use with CPAP
- Set up the diffuser right below the CPAP filter intake, add a drop of essential oil to the pad and the fragrance is drawn into the CPAP machine

Quick Tube Release Connector

Item# **CAP1016**
Each

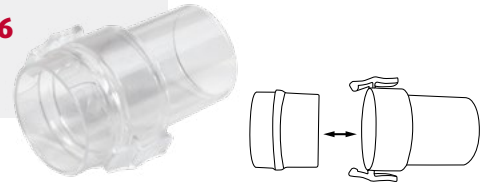

Inline Bacterial Viral Filter for CPAP/BIPAP/Vent Units

Item# **BF2200**
22mm
5/pack



Attach between the machine and tube for additional protection against bacteria and allergens

Circuit Connectors

Item# **RES013**
22mm OD x
15mm ID/
22mm OD
10/pack



Item# **RES014**
22mm OD x
22mm OD
With Lip
10/pack



Humidifier Tubing Adapter

Item# **RES016**
22mm ID x
22mm OD
with Lip
10/pack



Oxygen Bleed-In Adapter

Item# **RES019**
22mm with 6mm
Rotating Stem **10/pack**

RES019-CAP
With Stem Cap **10/pack**



Swivel Exhalation Port

Item# **VEN002**
For CPAP and
Ventilator Circuits



CASH ITEMS

CPAP Pillows

Item# **CAP4003**
 CPAPMax Pillow
 Each OEM# 15-501R-1-920



CPAPMax Replacement Cover
CAP4003RC
 Each OEM# 1-630-101-1-933

Replacement Pillow Case
CAP4003C
 Each OEM# 1-626-900-1-02



Cool 3D Mesh Air-Flow
 Reduces heat and perspiration



Fiberfill
 Soft microfiber pillow top with hypoallergenic fiberfill

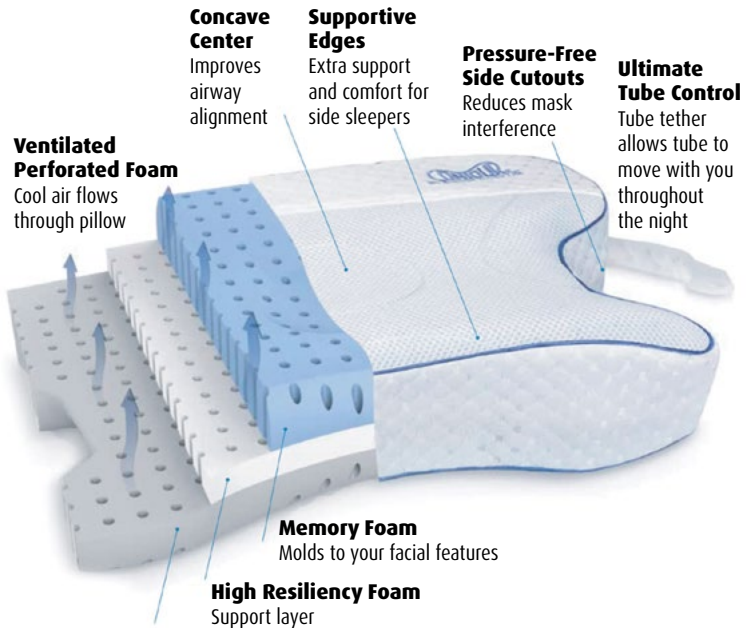

Charcoal Infused High Resiliency Foam
 Charcoal neutralizes odors for freshness every night

Item# **CAP4007**
 CoolPAP Pillow
 Each

Works with any style and brand of mask

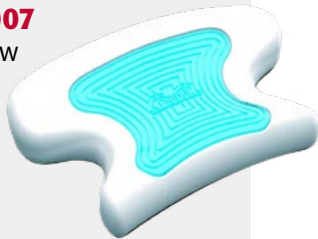

CoolPAP Pillow Cover
CAP4007C
 Each



BEFORE
 Traditional pillows interfere with mask performance and can cause a stiff neck, shifting, leaks, and facial discomfort.



AFTER
 The CPAPMax Pillow offers superb mask accommodation, excellent support, and unparalleled comfort.



CPAP Bedside Storage Bag

Item# **CAP1015**



- Well-made and stylish
- Designed to hold CPAP supplies such as a mask and tube
- Weighted lid allows bag to hang off top of nightstand or tabletop



CPAP Holder

Item# **CAP1010**



- Sits between mattress and boxspring
- Saves space by allowing machine to rest in the area between bed and nightstand
- CPAP machine is kept close to patient's head, allowing more freedom to move throughout the night
- Keeps machine below mask, to help prevent rainout



CASH ITEMS

Hush Strips®

Item#

CAP1025

Box of 32 Strips

NEW

Hush Strips® are designed to improve sleep quality by reducing mouth breathing and snoring during sleep

Hush Strips® sleep strips are made from medical grade nonwoven fabric and gentle easy-release adhesive, which moves with the skin flexibly, making them easy to reposition and remove.

Easy to apply residue-free material

The simple, non-invasive and easy to use anti-snoring strips are made of medical-grade hypoallergenic material which doesn't leave residue and is safe for both kids and adults.



How to use

1. Wash and dry lips
2. Remove strip from the liner
3. Close your mouth and turn lips slightly inward
4. Apply strip on lip and press to seal

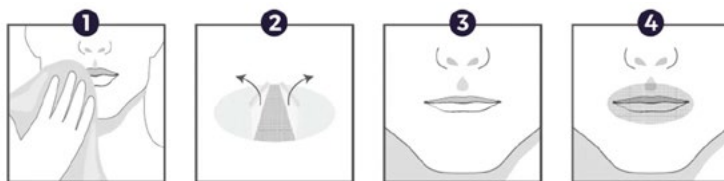

Deluxe Tubing Wrap

Item#

CAP2002

6ft Nylon Tubing Wrap

Each

Compare to ResMed Tubing Wrap



- 6ft nylon wrap with fleece lining maximizes heat retention and reduces noise
- Zipper closure for ease of use



Both Tubing Wraps come in attractive retail packaging

Comfort Tubing Wrap

Item#

CAP2001

6ft Velour Tubing Wrap

Each

Compare to Resprionics Tubing Wrap



- 6ft plush velour material adds comfort while preventing rainout
- Zipper closure for ease of use

Oxygen

Page

Pulse Oximeter	36
Firesafe	37
Concentrators	38
Masks	39
Cannula and Cannula Accessories	40-41
Tubing	41
Regulators and Conserver	42
Cylinder Carriers	44-45
Connectors	46
Accessories	46-48
Cleaners	48
Analyzers	49
Celon Wet Bands	49
Bacteria and HEPA Filters	50
Concentrator Cabinet Filters	51-56
Caire/AirSep/SeQual	51
CHAD	52
Covidien Nellcor Puritan Bennett	52
DeVilbiss/Drive	53
Invacare	54
Rhythm HC	55
Jumao, Lifestyle, Attendant, Medacure	55
3B	55
Nidek	55
Respironics/Healthdyne	56

OXYGEN PRODUCTS

Finger Pulse Oximeter

Item# **RES5102**

- Oversized 1.3" OLED display face is the largest of any finger pulse oximeter
- Features large numeric font
- Five grades of brightness adjustment
- Displays SpO2, PR and PI parameters and pulse wave graph
- Offers buzzer, demo and visual alarm functions
- Easy to navigate menu sets alarm limits or switches buzzer on/off
- CE, ISO and FDA approved
- Includes lanyard and manual



Disposable SpO2 Sensor Neonatal/Adult

Item# **RES7100**
20/box

- Comparable to Nellcor MAX-N
- For use with Nellcor PM100N Monitor

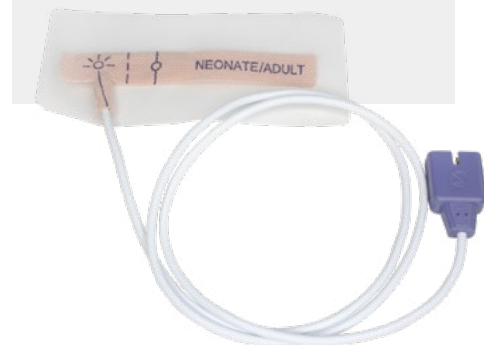

NEW

FIRESAFE

Firesafe Thermal Shut-Off Valve

Item#
RES010
Each

Bidirectional



- Smaller
- Laser etched
- Expiration date
- Human readable UDI
- Designed to last 5 years

- A thermal fuse designed to stop the flow of gas in the event that the downstream oxygen tubing is ignited
- Helps protect against oxygen tubing fires
- Helps keep patients safe no matter what method of oxygen delivery they use
- Offers a cost-effective solution to lower the risk of serious patient injury in an oxygen fire

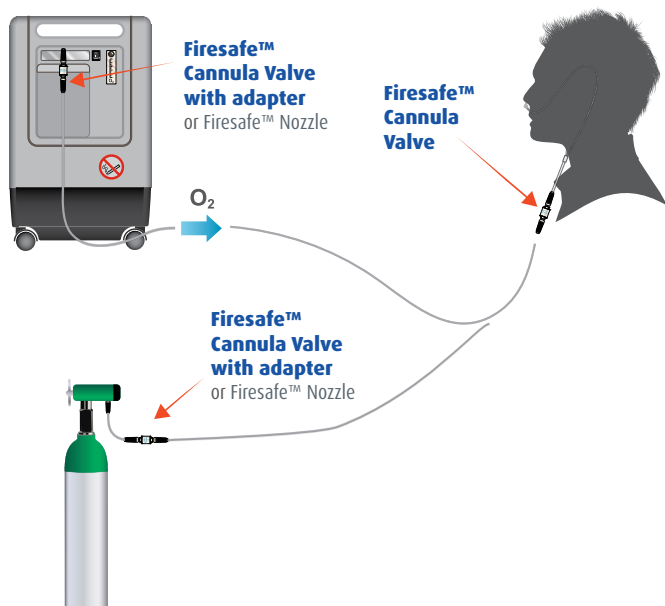

Home oxygen fires represent a much higher risk in the United States than the United Kingdom, where the fitting of thermal fuses for oxygen is mandatory.

Fatalities per 100,000 patients



* 1 death was reported among 73% of the patient population (2013-17)

FireSafe Kits

Item#
RES010KIT
2 Firesafe Valves
1 Tubing Connector

Item#
RES010CANNULAKIT
2 Firesafe Valves
1 Tubing Connector
1 Adult Soft Cannula

Item#
RES010VAKIT
2 Firesafe Cannula Valves
1 Tubing Connector
1 Cannula with Female Port
1 7ft Oxygen Supply Tube

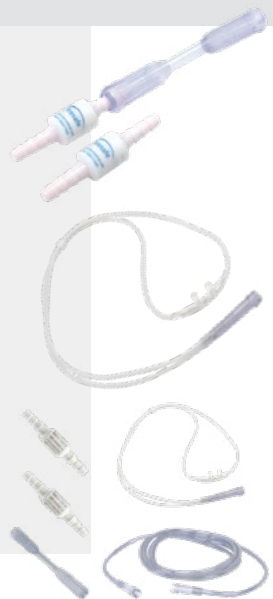

NEW

FireSafe Tubing Connector

Item#
RES010TC
100/case

RES010TC-10
10/case



FireSafe Nozzle

Item#
RES010FND-20
20/pack



Visit www.sunsethcs.com

SUNSET
HEALTHCARE SOLUTIONS

FIRESAFE

OXYGEN CONCENTRATORS

X-PLOR® Portable Oxygen Concentrator

Item#

RES50051

X-PLOR

NEW

RES50052

X-PLOR with Extra Battery

Lightweight and compact, the X-PLOR® is ideal for patients who want to replace their heavy oxygen tanks without missing a moment. The X-PLOR is also Bluetooth®-capable and can be connected to your mobile device through Belluscura's newly developed Nomad Biometrics™ App. With a rechargeable battery, easy-to-use interface, and high oxygen output, supplementary oxygen has never been more approachable or affordable.



Accessories

Item#

RES50073 User-Replaceable Sieve Bed Cartridge

RES50188 8-Cell Battery

RES53012 DC Power Adaptor

RES53011 AC Power Adaptor

RES52191 Carry Bag

RES52291 Backpack



What's Included

- X-PLOR® Unit
- 8-Cell Battery
- User-Replaceable Sieve Bed Cartridge
- Air Intake Filter
- AC Power Adaptor
- DC Power Adaptor
- Carry Bag With Handle & Shoulder Strap

Drive DeVilbiss Oxygen Concentrators

Item#

RES525DS

5 Liter

OEM# 525DS

Item#

RES1025DS

10 Liter

OEM# 1025DS



- Built upon a legacy of reliable, field-proven concentrator models, the DeVilbiss 5 Liter and 10 Liter Oxygen Concentrators were designed with enhanced quality, durability and simplicity in mind
- Patented DeVilbiss Turn-Down Technology minimizes wear on internal components, reduces power consumption by 15% or more and extends the life of the concentrator
- Exclusive DeVilbiss OSD (Oxygen Sensing Device), standard on every unit, ensures patient safety and reliability for longer service intervals
- Readily accessible patient controls, protected cannula fitting and recessed humidifier nook to prevent damage
- Alarms Audible and visual high/low pressure, low flow, low oxygen, power fail, Oxygen Sensing Device

Drive DeVilbiss iG02 Portable Oxygen Concentrator

Item#

RES125D

iG02

Item#

RES125D-XB

iG02 with Extra Battery



- Settings 1-5 Pulse Dose
- SmartDose Auto-Adjusting Conserver Technology included
- Rugged design, including protective overmold
- Weighs less than 5 lbs
- Most sensitive conserver trigger on the POC market

OXYGEN MASKS

Simple O₂ Mask

With 7ft Safety Tubing

Item# **RES2100**

Adult Size

50/case

Item# **RES2200V**

Pediatric Size

50/case



HCPCS# A4620

- 5-12 LPM
- Medium concentration
- Clear, soft vinyl for patient comfort
- Adjustable nose clip for secure seal



Partial Rebreather / Non-Rebreather O₂ Mask with 7ft Tubing

Oxygen High Concentration Mask with 7ft Safety Tubing and Reservoir Bag

Item# **RES2101V**

Adult Size

50/case

OEM# 8120-7-50

HCPCS# A4620

- 5-15 LPM
- Safety vent
- Clear, soft vinyl for patient comfort
- Adjustable nose clip for secure seal



Non-Rebreather O₂ Mask

With 7ft Safety Tubing & Reservoir Bag

Item# **RES2102**

Adult Size

50/case

Item# **RES2202V**

Pediatric Size

50/case

HCPCS# A4620

- 10+ LPM
- Low-resistance check valves prevent rebreathing and allow exhaled gas to escape



Visit www.sunsethcs.com

OXYGEN CANNULA

Cannula with Tubing

Adult Cannula with Tubing

Length	Material	Item#	Qty
4ft	Standard	RES1104	50/case
4ft	Soft	RES1104S	50/case
7ft	Standard	RES1107	50/case
7ft	Soft	RES1107S	50/case
15ft	Standard	RES1115	50/case
25ft	Standard	RES1125	25/case
25ft	Soft	RES1125S	25/case



Item#

RES1207V
Pediatric Cannula
with 7ft Supply Tube
50/case



RES1307V
Infant Cannula
with 7ft Supply Tube
50/case



HCPCS# A4615

- Clean, fresh look
- 1-6 LPM
- Curved nasal prongs for added comfort
- 6-channel safety tubing designed to prevent kinks
- Soft, lightweight material is memory free for long-term comfort

Cannula without Tubing

Adult Cannula without Tubing

Port	Material	Item#	Qty
Male	Standard	RES1100	50/case
Male	Soft	RES1100S	50/case
Female	Soft	RES1100FS	50/case

HCPCS# A4615

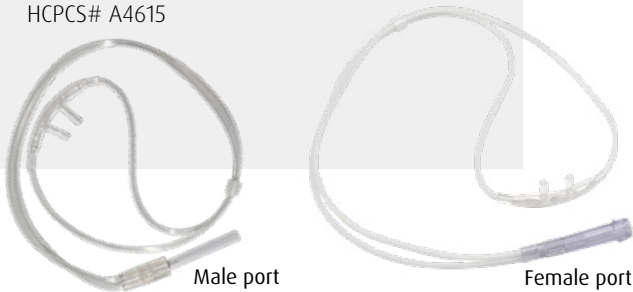

Male port

Female port

Dual-Lumen (Demand) Cannula

Item# **RES4147V**
7ft
25/case
HCPCS# A4615

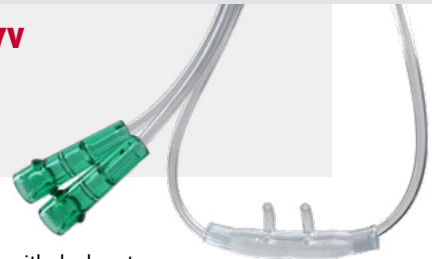

- 1-6 LPM
- Designed for use with dual port oxygen conservation delivery systems
- Dual tubing set provides independent tubes for oxygen delivery and sensing of patient breathing
- Smoothbore tubing

High Flow Soft Cannula

Length	Item#	Qty
4ft	RES1104SHF	25/case
7ft	RES1107SHF	25/case
15ft	RES1115SHF	25/case
25ft	RES1125SHF	25/case

HCPCS# A4615



- Now softer
- 6-15 LPM
- Maintains saturation for high-flow patients without a mask
- 6-channel supply tubing for safety

OXYGEN CANNULA AND TUBING

Humidoflo High Flow Nasal Cannula

10/case

Size	Item#
Small	HFN001AS
Medium	HFN001AM
Large	HFN001AL

With F&P Adapter

Size	Item#
Small	HFN001ASA
Medium	HFN001AMA
Large	HFN001ALA

HFN001-FPA F&P Adapter

With Nasal High Flow (NHF) therapy, patients benefit from warmed, humidified oxygen at a flow rate greater than those seen with conventional oxygen delivery devices, and more than peak inspiratory airflow. NHF treatment is better tolerable due to the heated and humidified air. The NHF apparatus is also smaller and more comfortable on the face than an NIV mask. Patients can continue eating, drinking and talking during treatment, leading to higher compliance. Delivery respiratory gases range from 2 - 60 L/min and O₂ concentrations range from 21 - 100%. NHF is intended for patients in homes and long-term care facilities and may help prevent intubation.



- Tube Side Quick Switch connects tube to either side of the patient
- Kink-free prongs and flexible, low-noise tube
- Compatible with any ventilator with a standard 22mm ISO connector, including Resprionics V60
- Suitable alternative to Philips AC611
- Can be used with F&P 850 and 950 with HFN001-FPA adapter
- Comparable to F&P OptiFlow cannula (OPT942, OPT944, OPT946)

Secure Cannula Stickers

Item# **RES080**
25 pairs/case

- Holds cannula in place
- Easy to use
- Flexible, sheer fabric
- Designed to let skin breathe and peel off without leaving residue
- Latex-free
- Individually wrapped pairs

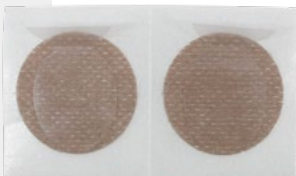

Comfort Cannula with Ear Cushions

Item# **RES1107EC**
7ft Cannula with Ear Cushions
25/case
HCPCS# A4615



Item# **RES020**
Cushions Only
50 Pairs/case

- Add cushions to existing cannula



OXYGEN TUBING

Oxygen Supply Tube



Length	Item#	Qty
7ft	RES3007	50/case
15ft	RES3015	50/case
25ft	RES3025	25/case
40ft	RES3040	20/case
50ft	RES3050	20/case

HCPCS# A4616

- Crush resistant with low memory to prevent kinking
- Great durability and comfort level
- Latex-free
- 1-6 LPM
- 6 channels

Oxygen Supply Tube — Green



Length	Item#	Qty
7ft	RES3007G	50/case
15ft	RES3015G	50/case
25ft	RES3025G	25/case
40ft	RES3040G	20/case
50ft	RES3050G	20/case

HCPCS# A4616

Visit www.sunsethcs.com



OXYGEN REGULATORS AND CONSERVER

Mini Oxygen Regulator CGA 870 Style



"T" Handle for easy mounting — no tools needed

Barbed hose outlet for easy connection to the oxygen tubing

For use with E size or smaller cylinders: A, B, C, D, JD, E, M2, M4, M6, ML6, M7, M9, M15, M22, or M24.



Item# **RES042**
Adult • Barbed
0-8 LPM • **Each**
0, .5, 1, 1.5, 2, 2.5,
3, 4, 5, 6, 7, 8 LPM

Item# **RES043**
Adult • Barbed
0-15 LPM • **Each**
0, .5, 1, 1.5, 2, 3, 4,
5, 6, 8, 10, 15 LPM

Item# **RES046**
Pediatric • Barbed
0-4 LPM • **Each**
0, 1/32, 1/16, 1/8,
1/4, 1/2, 3/4, 1,
1 1/2, 2, 3, 4 LPM

HCPCS# E1353

Mini Oxygen Regulator CGA 540 Style



Threaded DISS outlet

For use with M60 and larger cylinders: M60, M90, M, MM, M122, M250, H, J, T or other cylinders with CGA 540 style valve.



Item# **RES044**
Adult • DISS
0-8 LPM • **Each**
0, .5, 1, 1.5, 2, 2.5, 3,
4, 5, 6, 7, 8 LPM

Item# **RES045**
Adult • DISS
0-15 LPM • **Each**
0, .5, 1, 1.5, 2, 3, 4, 5,
6, 8, 10, 15 LPM

Item# **RES047**
Pediatric • DISS
0-4 LPM • **Each**
0, 1/32, 1/16, 1/8,
1/4, 1/2, 3/4, 1,
1 1/2, 2, 3, 4 LPM

HCPCS# E1353

Both Regulators Feature

- Pressure gauge reads to 3000 PSI
- Easy-click flow selector knob
- 2-year warranty



Pediatric models have a green dial cap



Private label laser etching now available!

Ask your rep for details.

Oxygen Regulator CGA 540 Style Long Stem



Item# **RES045L**
Adult • DISS
0-15 LPM • **Each**
0, .5, 1, 1.5, 2, 3, 4, 5,
6, 8, 10, 15 LPM

Bonsai Pneumatic Conserver

Item# **RES049**
Single Lumen • Barbed Outlet
Each



- Delivers a uniform oxygen pulse at increments: 1, 2, 3, 4, 5, and 6
- Two continuous flow (CF) settings preset @ 2 LPM and 4 LPM
- Delivers up to a 6:1 savings ratio from 14-40 breaths per minute
- Senses breath/delivers oxygen in first half of inspiratory cycle
- Operating pressure range: 200-3000 PSI
- Light weight and quiet operation
- Easy to operate single selector knob
- Compact design fits easily in virtually any oxygen carry bag
- Limited 2-year warranty

Sample Oxygen Cylinder Specifications*

Use the handy chart below to determine which accessories to purchase for your oxygen cylinder.

* This information is intended to be used as a guide. Dimensions may vary by manufacturer. Sunset Healthcare Solutions does not sell oxygen tanks.



Older Name		A	B			C	D	JD	E		
Newer Name	M2	M4	M6	ML6	M7	M9	M15	M22	M24	M60	M/MM/M122
Diameter (in.)	2.5	3.2	3.2	4.3	4.3	4.3	4.3	5.3	4.3	7.3	8
Height (in.)	5.3	8.5	11.5	7.6	9.1	11	16.5	16.5	25.5	23	36
Empty Weight (lb)	0.7	1.6	2.2	2.8	3.3	3.7	5.3	8	7.9	22.3	39.5
Capacity (L)	42	113	164	165	198	255	425	640	680	1738	3455
Transport Method	CSBM6, CSBM6BP	CSBM6, CSBM6BP	CSBM6, CSBM6BP, CSBM6Flex, CSBM6-carrier	CSBML6M7, CSBML6-Hardshell	CSBML6M7	CSBM9, CSBM6BP, CSBM6Flex, RES038B	CSBD, CSBDDBP, CSBD1Roller, CSBD2Roller, RES038B, RES060		CSBE, CSBD1Roller, CSBD2Roller, RES038B, RES060	Not Portable	Not Portable
Regulator Type	RES042, RES043	RES042, RES043	RES042, RES043	RES042, RES043	RES042, RES043	RES042, RES043	RES042, RES043	RES042, RES043	RES042, RES043	RES044, RES045	RES044, RES045

OXYGEN HCPCS

A4615	Cannula, nasal
A4616	Oxygen tubing, per foot
A4620	Oxygen mask, variable concentration
E0424	Stationary compressed gaseous oxygen system, rental
E0431	Portable gaseous oxygen system, rental
E0443	Portable oxygen contents, gaseous (for use only with portable gaseous systems when no stationary gas or liquid system is used), 1 month supply = 1 unit
E0445	Oximeter device for measuring blood oxygen levels non-invasively
E0560	Humidifier, durable for supplemental humidification during IPPB treatment or oxygen delivery
E1353	Oxygen supply regulator
E1354	Oxygen supply wheeled cart
E1355	Oxygen supply stand/rack
E1390	Oxygen concentrator, single delivery port, capable of delivering 85% or greater oxygen concentration at the prescribed flow rate
E1391	Oxygen concentrator, dual delivery port, capable of delivering 85% or greater oxygen concentration at the prescribed flow rate
E1392	Portable oxygen concentrator, rental
K0738	Portable gaseous oxygen system, rental; home compressor used to fill portable oxygen cylinders; includes portable containers, regulators, flow meter, humidifier, cannula or mask and tubing

CYLINDER BAGS

Comfort Shoulder Bags

Cylinder	Item#
ML6/M7	CSBML6M7
C/M9	CSBM9
B/M6	CSBM6
D	CSBD



CASH ITEM

- Comfort flex shoulder strap
- Double zipper for easy access
- Machine washable



CSBML6M7



CSBM9



CSBM6



CSBD

Flex O2 Bag

Item#
CSBM6Flex
Reconfigurable Bag
for M6 and M9
Cylinders
Each

- Adjusts to 5 carrying modes



CASH ITEM

Backpack

Cylinder	Item#
B/M6/C/M9	CSBM6BP
D	CSBDBP



CASH ITEM



- Fully adjustable and comfortable backpack straps
- Machine washable
- Converts to either backpack or shoulder bag

Wheelchair/Scooter Carrier

Item# **CSBE**
For E Cylinders
Each



CASH ITEM



- Multi-part stabilizer straps for easy chair attachment
- Machine washable

CYLINDER CARRIERS

Single Tank Rolling Bag/Backpack

Item#
CSBD1Roller
For D/E Cylinders
Each



Double Tank Rolling/Shoulder Bag

Item#
CSBD2Roller
For D/E Cylinders
Each



- May also be used with shoulder strap

ML6 Hardshell Tote

Item#
CSBML6-Hardshell
For Homefill Cylinders
Each



Cylinder Rack

Item# **RES038B**
For D, E, or M9 Cylinders —
Lightweight, Durable
Plastic Composite Rack
Each



Oxygen Cylinder Carrier

Item#
CSBM6-Carrier
Soft Polyester Tote
for M6 Cylinders
Each



- Tote handles
- Padded shoulder strap
- Fastening strap for mobility
- Holds up to 8 M6 tanks

D/E Cart

Item#
RES060
4/case

- Accommodates one D or E tank
- Sturdy yet lightweight (4.18 LBS welded metal construction)
- Adjustable height handle with PVC grip
- Large EVA Foam wheels have just the right amount of resilience for good traction and maneuverability
- Elegant, grey satin finish
- Bottom fork rest with rubber caps



OXYGEN CONNECTORS AND ACCESSORIES

Christmas Tree Connector

Item# **RES001**
Green without Swivel
10/pack



Item# **RES002**
Green with Swivel
10/pack



- Tapered and barbed nut and nipple assembly allows secure tubing connections
- For standard DISS threaded oxygen outlets
- Improved threading is easier to connect to regulators or flow meters

Oxygen Accessory Kit

Item# **RES1000**
RES002 Christmas Tree Connector - Swivel
RES012 Tubing Connector - Non-Swivel
RES017 Tubing Y-Connector
RES018 Tubing Connector - Swivel
RES032 Wrench
RES035 Brass Washer

Each



CUSTOMIZABLE KIT



- Order all common oxygen accessories in one easy-to-handle kit
- Contents can be customized to fit your needs

Oxygen Tubing Y-Connector

Item# **RES017**
Fits 3/16in and 1/4in ID Tubing
(All 3 sides are the same)
10/pack



- Connects 2 oxygen sources for higher flows

Oxygen Tubing Connector — Non-Swivel

Item# **RES012**
Fits 3/16in and 1/4in ID Tubing
10/pack



- Barbed ends ensure secure, leak-free connections

Oxygen In Use Signs

Item# **RES003**
6in x 9in
With String
50/pack



- Double-sided (English and Spanish)

Oxygen Tubing Connector — Swivel

Item# **RES018**
Male/Male **10/pack**



RES018-25 25/pack

RES018KIT-1
Female/Male **Each**



- Enhance patient mobility and comfort by minimizing twisting and tangling of oxygen supply tubing

Washers with Rubber Ring

Item# **RES035**
Brass
25/pack



Item# **RES036**
Aluminum
25/pack



OXYGEN ACCESSORIES

O₂ Starter Kit

Item# **RES02KIT**

RES1107 Cannula with 7ft Tube x2
 RES3015 15ft Supply Tube x2
 RES002 Christmas Tree Connector — Swivel
 RES003 Oxygen In Use Sign
 RES012 Tubing Connector — Non-Swivel
 RES017 Tubing Y-Connector
 RES018 Tubing Connector — Swivel
 RES032 Wrench
 RES035 Brass Washer



CUSTOMIZABLE KIT

Wrenches and Chains

Item# **RES031**

With Chain **10/pack**

Item# **RES032**

Without Chain **10/pack**



- For use with post valve oxygen cylinders: A, B, C, D, JD or E tanks
- Made of tough, stress-resistant nylon

Item# **RES031M**

Metal Wrench with Chain for Post Valve Oxygen Cylinders and CGA 540 Style Regulators **5/pack**



Item# **RES031-CHAIN**

12in Ball Chain with Coupling Connector **50/pack**

- Add chain to an oxygen valve wrench



Item# **RES031-BW**

Cylinder Wrench with Two-Ring Bungee and Two Yoke Washers **10/pack**



Disposable Bubble Humidifier 500 ml

Item#

RES050

Up to 15 LPM • 6 psi • 500 ml
50/case

HCPSC# E0560

OEM# HUM001



- Multi-threaded lid ensures a secure fit, preventing leaks and service calls
- Audible back pressure alarm activates at 6 psi
- No aluminum fitting in stem eliminates aluminum shreds often found in lower quality models
- Soft plastic diffuser reduces clogging due to mineral build-up
- Translucent jar provides improved visibility of jar contents
- Humidifier bottle lid is colored green/yellow, making it easy to tell patients on the phone how to change the bottle
- Bottle fill line is very easy to see
- Finger grips at the top of the bottle make the lid easier to screw on/off for the patient

Humidifier Connectors

Item# **HUM008**

L-Connector 12in • **10/pk**

Item# **HUM008L**

L-Connector 21in • **10/pk**

Item# **HUM008S**

Straight Connector 9in • **10/pk**



Water Traps

Item# **RES037**

Push On End Caps • **Each**

Item# **RES037T**

Threaded End Caps • **Each**

- Keeps water out of cannula
- Connects between cannula and supply tubing
- Removable end caps allows drainage of accumulated water
- 9cc water capacity in horizontal position



ACCESSORIES AND CLEANERS

Homefill Tubing Connector

Item# **RES039**
10/pack



- Compatible with Invacare, Drive, and Respiration homefill machines
- Durable, coiled tubing

Homefill Racks

Item# **RES039-RACKB**
For Invacare Perfecto2
4/case

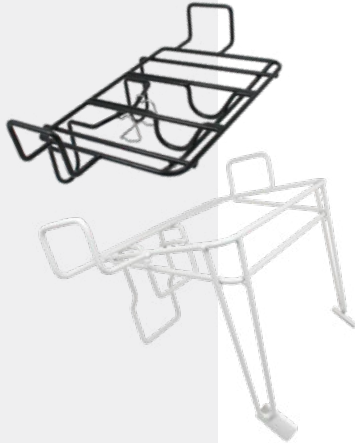

RES039-RACKW
For Invacare Platinum
4/case

RES039-RACKD
For DeVilbiss 525/1025 Series
4/case

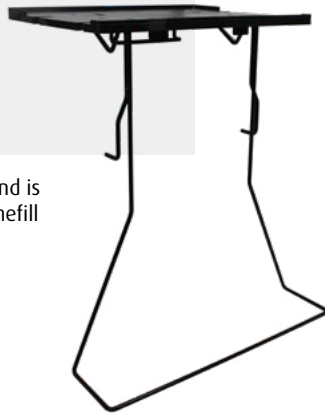

Easily attaches onto concentrator and is designed to conveniently hold Homefill and transfill oxygen systems.

Oxygen Liter Meter

Item# **RES034**
0-10 Liter/Minute
Each



- Oxygen pen
- Works with tanks and concentrators

RoEzIt Dermal Care

Item# **RES6104L**
1oz Tube • 18/case



- Apply before beginning oxygen therapy and as needed during treatment
- Moisturizes the nose, lip, and over the ear where friction may cause discomfort from cannula
- Petroleum-free with aloe vera and vitamins A and E



CASH ITEM

Germicidal Deodorizing Cleaner

Item# **RES6100**
22oz spray bottles
12/case



- Ready-to-use spray cleans, disinfects and deodorizes
- Formulated for use on hard, non-porous surfaces
- Bactericidal, Tuberculocidal, Fungicidal, Mildewstat
- Contains no abrasives, bleach, phosphates or phosphorous
- Effective against SARS-CoV-2 (COVID 19 virus) on hard non-porous surfaces

Germicidal Deodorizing Cleaner — Gallon

Item# **RES6102**
1 Gallon



- No-scrub, hospital strength germicidal cleaner
- Cleans, deodorizes, and disinfects surfaces, equipment and non-critical instruments

OXYGEN ACCESSORIES

Maxtec UltraMax O2 Oxygen Analyzer

Item# **RES7000** **NEW**
Each

The UltraMaxO2 helps oxygen concentrator service technicians looking to save on costs and time when checking patient O2 concentrators.

With integrated oxygen, flow, and outlet pressure monitoring in a single device, this handheld unit is easy to operate, store, and transport and does not require a traditional electrochemical sensor, which reduces the overall maintenance and minimizes the cost of ownership.



- Reduced cost of ownership with the ultrasonic sensor
- No in-field calibration required
- Quick set-up and readouts
- Ability to check outlet pressure

Maxtec MaxO2+A Oxygen Analyzer

Item# **RES7001** **NEW**
Each

The MaxO2+A was designed with simplicity and portability in mind. This analyzer quickly adapts for use in tubing applications and is ideal for checking oxygen percent accuracy in line or on concentrators. Its patented ergonomic design fits comfortably in the hand and features a simple one-touch on/off control and calibration. The MaxO2+A will calibrate to room air (20.9%) or 100% oxygen. For applications needing an external sensor, check out our MaxO2+AE.

- Features an integrated MAX-250+ long life sensor
- 5,000+ hours operation on 2 AA batteries
- Easy one-touch calibration
- Patented ergonomic design
- Quickly adapts to bore tube applications
- 24-month warranty on both the analyzer and sensor



Max-250+ Maxtec Compatible Oxygen Sensor

Item# **RES7001-SENS**
Each



Celon Wet Bands

NEW

Item# **WB66120**
66 x 120mm
for CGA 540 Valves
Bucket of 1,500



Item# **WB30540**
30.5 x 40mm
for CGA 870 Valves
Bucket of 11,500



Item# **WB30525**
30.5 x 25mm
for CGA 870 Valves
Bucket of 18,000



Create a perfect seal to protect oxygen tank valves

Easy to apply, safe and effective
Biodegradable and sustainable material

- Eliminates dust, dirt & dampness
- Hand applied
- Heat-free solution
- Creates a secure and wrinkle-free seal

- Professional finish
- Environmentally friendly
- Biodegradable

Visit www.sunsethcs.com



OXYGEN BACTERIA AND HEPA FILTERS

6in HEPA Capsule with Removable Sticker

Item# **BFH6S**
Threaded
Each



Intake Bacteria Filter

Item# **BF2222**
22mm fittings
5/pack



EverFlo Intake Filter

Item# **BF1001**
Each
Respironics OEM# 1038831

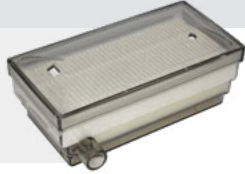

Extended Life Bacteria Filter with Muffler

Item#
OF6011
Each

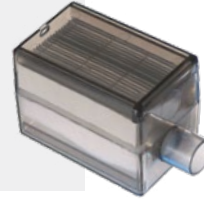

Extended Life Bacteria Filter

Item# **BF5000**
Nonthreaded
Each



Extended Life Intake Bacteria Filter

Item#
OF1025D
Each



Extended Life Intake Bacteria Filter

Item# **BF1103**
Each



Intake Bacteria Filter

Item# **BF7000**
Compatible with Jumao JMC5A,
Attendant 8X899, Lifestyle
LM5A, Medacure OCSL &
Rhythm LM5CA Concentrators
Each



Final Bacteria Filter

Item# **BF516**
1/4in Barbed
on Both Sides
10/pack



Final Bacteria Filter — 1/4in to 3/8in

1/4in —
3/8in —

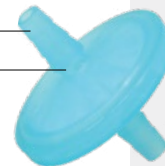

Item# **BF1438**
1/4in to 3/8in
Stepped Barb
on Both Sides
10/pack

Respironics SimplyGo Style Inlet Filter

Item#
BF8000
Each

NEW



HEPA Filter for 3B Stratus

Item# **BF6020**
HEPA Filter
Each
OEM# STR1020



Final Bacteria Filter — 3/16in



Item# **BF316**
3/16 Stepped Barb
and 1/4in Straight
Barb on Both Sides
10/pack

CAIRE/AIRSEP/SEQUAL

SeQual Integra



Item# **OF11005**
Foam Cabinet Filter
10/pack
75/8" x 35/8"-5 x 3/4"
OEM# 2185

Item# **BF5000**
Extended Life
Bacteria Filter
Each
OEM# 2033

Item# **BF516**
Final Bacteria Filter
1/4in Barbed
10/pack

Item# **OF11005SP**
SeQual Kit
2 - OF11005
1 - BF5000
1 - BF516
Each

KIT

AirSep Newlife, QuietLife, Intensity



Item# **OF8002**
Foam Cabinet Filter
10/pack
51/4" x 47/8" x 7/8"
OEM# F1-50-08-05

Item# **BF1438**
Final Bacteria Filter
1/4in to 3/8in
Barbed
10/pack
OEM# F1-30-03

Item# **OF8001**
Felt Filter
10/pack
17/8" OD x 3/4" ID x 1"
OEM# M1 161-1

Item# **OF8002SP**
Newlife Kit
2 - OF8002
1 - BF1438
1 - OF8001
Each

KIT

CAIRE Companion 5



Item# **BF1103**
Extended Life Intake
Bacteria Filter
Each
OEM# 2185

SeQual Eclipse



Item# **OF11006**
Foam Cabinet Filter
10/pack
21/2" x 21/2" x 3/4"

CHAD

Total O₂



Item# BF2222
Intake Bacteria Filter
22mm fittings
5/pack
Healthyne OEM# 100-6631-00
Respironics OEM# H620



Item# OF3003
Foam Intake Filter
for use with BF2222
25/8" OD x 3/4" ID x 23/8"
10/pack
OEM# H613

COVIDIEN NELLCOR PURITAN BENNETT

590 and 592A



Item# OF6001
Foam Cabinet Filter
63/4" x 41/4" x 3/8"
10/pack
OEM# 492672



Item# BF5000
Extended Life
Bacteria Filter
Each



KIT

Item# OF6001SP
590 and 592 Kit
2 - OF6001
1 - BF5000
1 - BF316
Each



Item# BF316
Final Bacteria Filter
3/16 Stepped Barb and
1/4in Straight Barb
10/pack
OEM# 492141

SolAiris III, 303 Series



Item#
OF5004SP
SolAiris III Kit
2 - OF5004
1 - BF1438
1 - BF5000
Each



Item# **OF5004**
Foam Cabinet Filter
33/4" x 33/4" x 1/2"
10/pack
OEM# 30302605



Item# **BF1438**
Final Bacteria Filter
1/4in to 3/8in Barbed
10/pack
OEM# MC29D-651



Item# **BF5000**
Extended Life
Bacteria Filter
Each

1025 Series



Item# **OF1025D**
Extended Life Bacteria
Filter
Each



Item# **OF5004**
Foam Cabinet Filter
33/4" x 33/4" x 1/2"
10/pack
OEM# 303DZ-605



Item# **BF1438**
Final Bacteria Filter
1/4in to 3/8in Barbed
10/pack
OEM# MC29D-651



SolAiris V, 505, 515 Series



Item#
OF5005SP
SolAiris V Kit
2 - OF5005
1 - OF6011
1 - BF1438
Each



Item# **OF5005**
Foam Cabinet Filter
51/2" x 35/8" x 5/8"
10/pack
OEM# 50502694



Item# **BF1438**
Final Bacteria Filter
1/4in to 3/8in Barbed
10/pack
OEM# MC29D-651



Item# **BF5000**
Extended Life
Bacteria Filter
Each



Item# **OF6011**
Extended Life Bacteria
Filter—22mm fittings
Each
Use if SolAiris was
manufactured before
Nov '03

525 DS Series



Item# **OF5004**
Foam Cabinet Filter
33/4" x 33/4" x 1/2"
10/pack
OEM# 303DZ-605



Item# **BF1438**
Final Bacteria Filter
1/4in to 3/8in Barbed
10/pack
OEM# MC29D-651



Item#
RES515LF607
Low Output Flow Meter
Each
OEM# 515LF-607

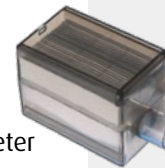

Item# **OF6011**
Extended Life Bacteria
Filter — 22mm fittings
Each

All MC Units



Item# **OF5001**
Foam Cabinet Filter
10/pack
61/8" x 31/2" x 1/4"
OEM# 444-514



Item# **BF5000**
Extended Life Bacteria
Filter • **Each**
Nidek OEM# 9250-1028
SeQual OEM# 2033



Item#
OF5001SP
MC Kit
2 - OF5001
1 - BF5000
1 - BF1438
Each

Item# **BF1438**
Final Bacteria Filter
1/4in to 3/8in Barbed
10/pack
OEM# MC29D-651



INVACARE

Mobilaire 3 and 5



Item# **OF9001**
Foam Cabinet Filter
63/4" x 33/8" x 1/2"
10/pack
OEM# 2000489

Item# **OF9001SP**
Mobilaire Kit
2 - OF9001
1 - BFH6S
1 - BF516
Each



Item# **BFH6S**
HEPA Filter
6in Capsule
Each
OEM# 2000806



Item# **BF516**
Final Bacteria Filter
1/4in Barbed
10/pack
OEM# P0750X030

Platinum 5 and 10



Item# **OF9002**
Foam Cabinet Filter 9" x 27/8" x 1/2"
10/pack
OEM#1107412

Item# **OF9002SP**
Platinum Kit
2 - OF9002
1 - BFH6S
1 - BF516
Each



Item# **BFH6S**
HEPA Filter 6in Capsule with Sticker
Each
OEM# 2000806



Item# **BF516**
Final Bacteria Filter 1/4" Barbed
10/pack
OEM# P0750X030



Item# **HUM008S**
Straight Humidifier Connector w/
9in Tube
10/pack

Perfecto2



Item# **OF9004**
Foam Cabinet Filter
67/8" x 33/4" x 1/2"
10/pack
OEM# 1143492

Item# **OF9004SP**
Perfecto2 Kit
2 - OF9004
1 - BFH6S
1 - BF516
Each



Item# **BFH6S**
HEPA Filter 6in Capsule
Each
OEM# 2000806



Item# **BF516**
Final Bacteria Filter
1/4in Barbed
10/pack
OEM# P0750X030

HomeFill



Item# **OF9001**
Foam Cabinet Filter
63/4" x 33/8" x 1/2"
10/pack
OEM# 2000489



Item# **RP008**
Invacare HomeFill
Compressor 2000psi
Pressure Switch
Each
Replaces# 1089467

Replacement Parts

NEW



Item# **RP001**
Pilot Valve + 1 O-Ring for Invacare
Each
OEM# 2003052



Item# **RP002**
O-Ring for Invacare Pilot Valve
25/pack
OEM# 1085112



Item# **RP003**
PE Valve for Invacare
Each
OEM# 1143578



Item# **RP004**
On/Off Switch for Lifestyle, DeVilbiss, Invacare
Each
Replaces #1139950



Item# **RP005**
Hour Meter for Invacare and Direct Supply
Each
Replaces #2002939



Item# **RP006**
O₂ Conc Hose Barb Fitting 1/8" Conc Port
Invacare and EverFlo Post 2013
Each
Replaces# 1104151



Item# **RP007**
O₂ Conc Fitting Receptical HF Port Invacare and
EverFlo Post 2013
Each
Replaces# 1104152

RHYTHM HC, ATTENDANT, LIFESTYLE, MEDACURE

Rhythm LM5CA, Jumao JMC5A, Attendant 8X899,
Lifestyle LM5A, Medacure OC5L

• Rhythm LM5CA



Item# **OF7001-10**
Foam Cabinet Filter
10/pack
OEM# LM209069

• Jumao JMC5A, Attendant 8X899, Lifestyle LM5A, and Medacure OC5L



Item# **OF7000**
Foam Cabinet Filter
10/pack



Item# **BF7000**
Intake Filter
Each
OEM# LM209066



Item# **BF516**
Final Bacteria Filter,
1/4in Barbed
10/pack
OEM# LM209068

3B

Stratus 5



Item# **OF6030**
Foam Cabinet Filter
10/pack
OEM# STR1030



Item# **BF6020**
HEPA Filter
Each
OEM# STR1020



Item# **BF516**
Final Bacteria Filter,
1/4in Barbed
10/pack
OEM# P0750X030

RHYTHM HC

Rhythm HC LM5BA



Item# **OF8000**
Foam Cabinet Filter
10/pack
OEM# LM5BA-ITF



Item# **OF6011**
Extended Life
Bacteria Filter —
22mm fittings
Each
OEM# LM5BA-ILF



Item# **BF516**
Final Bacteria Filter,
1/4in Barbed
10/pack
OEM# LM5BA-BF

NIDEK

Nuvo



Item# **OF11003**
Foam Cabinet Filter
9 1/2" x 4" x 1/4"
10/pack
OEM# 9250-1025



Item# **BF1438**
Final Bacteria Filter
1/4in to 3/8in Barbed
10/pack
OEM# 7631-1053

Item#
OF11003SP
Nuvo Kit
2 - OF11003
1 - BF1438
1 - BF5000
Each



Item# **BF5000**
Extended Life
Bacteria Filter
Each
OEM# 9250-1028

Mark IV, V, V+



Item# **BF1438**
Final Bacteria Filter
1/4in to 3/8in
Barbed
10/pack
OEM# 7631-1053

RESPIRONICS/HEALTHDYNE

EverGo



Item# OF1005
Foam Cabinet Filter
2³/₁₆" x 1¹/₁₆" x 3³/₈"
10/pack
OEM# 900-150

Item# OF1005SP
EverGo Kit
2 - OF1005
1 - BF316
Each



Item# BF316
Final Bacteria Filter
3/16in Stepped Barb
and 1/4in Straight Barb
10/pack
OEM# H621

Millennium



Item# OF1001
Foam Cabinet Filter
8¹/₄" x 4" x 3³/₈"
(3/16" notches)
10/pack
OEM# H619

Item# OF1001SP
Millennium Kit
2 - OF1001
1 - BF2222
1 - OF3003
1 - BF316
Each



Item# BF2222
Intake Bacteria Filter
22mm fittings
5/pack
OEM# H620



Item# OF3003
Foam Intake Filter
for use with BF2222
2⁵/₈" OD x 3³/₄" ID x 2³/₈"
10/pack
OEM# H618



Item# BF316
Final Bacteria Filter
3/16 Stepped Barb,
1/4in Straight Barb
10/pack
OEM# H621



Item# OF1002
Felt Filter
6/pack

SimplyGo



Item# BF8000
Inlet Filter
Each
OEM# 1095248



Item# RES1008
Mini Compressor Filter
Each

Alliance

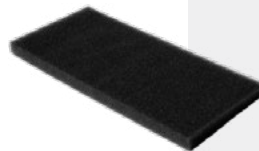

Item# OF3002
Foam Cabinet Filter
8¹/₄" x 3³/₄" x 1¹/₂"
10/pack
OEM# 100-0078-10

Item# OF3002SP
Alliance Kit
2 - OF3002
1 - BF2222
1 - OF3003
1 - BF316
Each



Item# BF2222
Intake Bacteria Filter
22mm fittings
5/pack
OEM# 100-6631-00



Item# OF3003
Foam Intake Filter
for use with BF2222
2⁵/₈" OD x 3³/₄" ID x 2³/₈"
10/pack
OEM# H618



Item# BF316
Final Bacteria Filter
3/16in Stepped Barb
and 1/4in Straight Barb
10/pack
OEM# H621

EverFlo



Item# OF1006SP
Cabinet Filter Kit
(No Cover)
2 Filters, 1 Casing
OEM# 1055625

Item# OF1003SP
EverFlo Kit
1 - BF1001
1 - BF316
Each



Item# OF1006
Cabinet Filter
5¹/₁₆" x 4¹/₂" x 7¹/₁₆"
10/pk



Item# OF1006-CASE
Foam Cabinet Filter
Casing
10/pack



Item# BF1001
EverFlo Intake Filter
Each
OEM# 1038831



Item# BF316
Final Bacteria Filter
3/16in Stepped Barb
and 1/4in Straight Barb
10/pack
OEM# H621

Item# HUM008
Humidifier
L-Connector
With 12in
Tube
10/pk

OTHER

Other

Page

Disinfectants	57
Aerosol	58
Tabletop Nebulizers	59
Handheld Nebulizers	60
Nebulizer Kits	61
Nebulizer and Anesthesia Filters	62
Suction	63-65
Closed Suction Systems	66-67
Tracheostomy	68
Ventilator Filters, Masks, and Connectors	69
Ventilator Circuits	70-71
StrongArm Comfort Cane	72
Bath Safety	73
Maternity	74-75
Wound Care	76-79

OTHER HCPCS

A6402	Gauze - sterile, pad size 16 sq. in. or less, without adhesive border, each dressing	A7013	Nebulizer Compressor Filter— Disposable
A4483	Heat and Moisture Exchanger — Disposable	A7015	Aerosol Mask used with Nebulizer
A4626	Tracheostomy Cleaning Brush	A7525	Tracheostomy Mask
A4628	Oropharyngeal Suction Catheter (Yankauer)	E0570	Nebulizer with Compressor
A4629	Tracheostomy Care Kit - for established tracheostomy	E0600	Respiratory Suction Pump - home model, portable or stationary, electronic
A7000	Suction Canister — Disposable	E2601	General Use Wheelchair Seat Cushion - width less than 22 inches, any depth
A7002	Tubing for Suction Pump	K1005	Disposable collection and storage bag for breast milk, any size, any type, each
A7003	Nebulizer Set - Small Volume—Disposable		
A7005	Nebulizer Set - Small Volume—Nondisposable		

DISINFECTANTS

Simpli Germicidal Disposable Wipes

Item#

RES6108W

Canister of 160 wipes

- Bactericidal, Tuberculocidal, Fungicidal, Virucidal*
- Premoistened wipes containing a quaternary/alcohol-based solution.
- Made in the USA.
- Kills *SARS-CoV-2, Covid 19, Mycobacterium bovis - BCG (Tuberculosis—TB) in 1 Minute
- Kills Candida Auris in 2 Minutes



CleanSmart Disinfectant

Item#

CAP1019-C

23oz Spray Bottle

6/case

- CleanSmart is EPA listed as a broad-spectrum and hospital disinfectant
- EPA Registration Number 89896-2
- CleanSmart is formulated for disinfecting surfaces of external medical equipment and external surfaces of respiratory equipment
- CleanSmart is included on the EPA's List N: Disinfectants for Use Against SARS-CoV-2, the virus that causes COVID-19
- Active ingredient Hypochlorous Acid does not leave a chemical residue



AEROSOL

Aerosol Mask

Item# **RES2110**
Adult Size
50/case

Item# **RES2210**
Pediatric Size
50/case

HCPCS# A7015



- Clear, soft vinyl for patient comfort
- Adjustable nose clip for secure seal
- Connector accepts 22mm aerosol tubing
- Individually packaged



Peak Flow Meter

Item# **RES052**
10/case

50-800 L/min

- High performance
- Quality controlled
- Color areas indicator
- Slip design
- One-way valve
- Latex-free
- Phthalate-free



Item# **RES052MPD**
Pediatric Mouthpiece
for Peak Flow Meter
10/case

Drainage Bag with T-Adapter

Item# **RES070**
750cc • **50/case**



- Designed to ensure patients receive mist rather than liquid accumulated in the tubing
- Includes hanger and bottom drainage port
- Works with 22mm corrugated aerosol tubing

Drainage Bag with Y-Adapter

Item# **RES071**
750cc • **50/case**



SperaChamber

Anti-Static Valved Inhaler Chamber
for Metered Dose Inhaler

Chamber Only

Item#
RES195-10 10/pack
RES195-50 50/pack

Chamber with Mask
10/pack

Item#
RES195MS Small (Infant)
RES195MM Medium (Pediatric)

RES195ML Large (Adult)

- Inhalation valve
- Universal adapter
- Spiral vents
- Seal with exhalation safety valve
- Latex-free and DEHP-free
- Dog mask appeals to kids



Mask Only

Size	Item#
Small	RES195S
Medium	RES195M
Large	RES195L



TABLETOP COMPRESSOR NEBULIZERS

Compressor Nebulizers

Item#

NEB100

- Disposable Nebulizer Kit with Angled Mouthpiece (RES096)
- Foam Filters (BF018 x5)

NEB100-R

- Disposable Nebulizer Kit with Angled Mouthpiece (RES096)
- Reusable T-Piece Kit (RES093)
- Foam Filters (BF018 x5)



NEB100-BAG
Carry Bag

Sunny the Bear



NEB300BEAR

- Disposable Pediatric Mask (RES2210)
- Disposable T-Piece Kit (RES091)
- Foam Filters (BF018 x5)

NEB300BEAR-R

- Disposable Pediatric Mask (RES2210)
- Disposable T-Piece Kit (RES091)
- Reusable T-Piece Kit (RES093)
- Foam Filters (BF018 x5)



- Rust-resistant
- Quiet (below 60dBA)
- 6ml medication capacity
- Average nebulization rate above 0.2ml/min
- Particle size: respirable fraction 0.5 to 5um 0.5um 80%
- Compressor pressure range 30-45 PSI
- Operation pressure range 12-14 PSI
- Liter flow range 8-10 LPM



NEW

NEB300-BAG

Bag for Nebulizer Compressor

To include bag in configuration, just add "B" to Item Number:

NEB300FISH-B

NEB300FISH-RB

NEB300BEAR-B

NEB300BEAR-RB

Gordon the Fish



NEB300FISH

- Disposable Pediatric Mask (RES2210)
- Disposable T-Piece Kit (RES091)
- Foam Filters (BF018 x5)

NEB300FISH-R

- Disposable Pediatric Mask (RES2210)
- Disposable T-Piece Kit (RES091)
- Reusable T-Piece Kit (RES093)
- Foam Filters (BF018 x5)



Visit www.sunsethcs.com



HANDHELD NEBULIZERS

Handheld Mesh Nebulizer

Item#
NEB402

With internal rechargeable battery

Included

Medication cup
USB cord
Mask
Mouthpiece
Portable bag
Manual



Particle Size MMAD < 5µm
Nebulization Rate 0.25ml/min-0.9ml/min
Medication Cup Capacity 10ml (Max)
Device Weight Approx. 1/4 lb
Device Size Approx. 1^{1/2} x 2 x 3^{7/8} inches

Handheld Compressor Nebulizer

Item#
NEB200

Included

Compressor
Medication cup
AC power adapter
Air hose
Elbow
Mouthpiece
Mask
4 AA batteries



- Runs on 4 AA batteries or AC power adapter
- Portable (small and weighs only 1/2 pound)
- Quiet (60dBA)
- Fine particle size (Approximately 3 microns)
- No replacement filter required

NEBULIZER KITS

Disposable Nebulizer Kit with T-Piece

Item# **RES091**
 Disposable
 Single Patient
50/case
 HCPCS# A7003

- Includes:
- 6cc jet nebulizer bottle
 - T-piece with mouthpiece and corrugated reservoir tube
 - 7ft supply tube

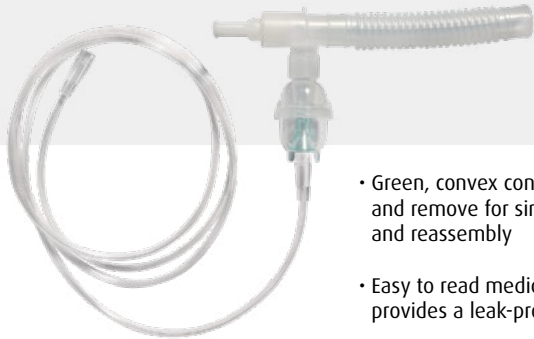

- Green, convex cone is easy to see and remove for simple cleaning and reassembly
- Easy to read medication jar provides a leak-proof seal

Reusable Nebulizer Kit with T-Piece

Item# **RES093**
 Reusable — Single Patient
10/case
 HCPCS# A7005

- Includes:
- 10cc jet nebulizer bottle
 - T-piece with mouthpiece and corrugated reservoir tube
 - 7ft supply tube



- Latex-free
- Dishwasher safe
- High capacity (10cc)
- CC volume markings
- Very low residual volume (0.7cc)
- 1/4 turn cap provides leakproof seal
- Works upright or at angles up to 45°

Disposable Nebulizer Kit with Angled Mouthpiece

Item# **RES096**
 Disposable
 Single Patient
50/case
 HCPCS# A7003



- Includes:
- 6cc jet nebulizer bottle
 - Angled mouthpiece
 - 7ft supply tube



Disposable Nebulizer Kit with Mask

Item# **RES090**
 Adult Size
50/case

Item# **RES092**
 Pediatric Size
50/case



HCPCS# A7003

Includes

- 6cc jet nebulizer bottle
- Mask
- 7ft supply tube

Disposable single patient use for long term delivery procedures

6cc bottle is easy to assemble and disassemble



NEBULIZER FILTERS

Plastic Intake Filter with Head

Item# **BF017**
5/pack
 HCPCS# A7013



Plastic Intake Filter with Head

Item# **BF016**
10/pack
 HCPCS# A7013



Plastic Intake Filter for Respironics InnoSpire

Item# **BF026S**
10/pack
 HCPCS# A7013



- Mini
- MicroElite
- MiniElite

Foam Filter

Item# **BF018**
10/pack
 HCPCS# A7013



Intake Filter for 50 PSI Compressor

Item# **BF020**
3/pack

NEW



Compatible with
 CHAD Drive
 50 PSI Compressor
 OEM# 18450-FILTER

Nebulizer Filter Compatibility

Caire		MedLine	
Medi-Mist	BF018	SportsMist	BF018
Chad		Respironics	
Drive	BF020	Inspiration 626 & 929	BF016
DeVilbiss		MisterNeb	BF016
PulmoNeb	BF017	Inspiration Elite	BF016
PulmoNeb LT	BF017	MiniElite	BF018
Sunrise Compact	BF018	InnoSpire	BF026S
Pulmo-Aide	BF017	Salter	
Pulmo-Aide Compact	BF017	AIRE Plus	BF018
PulmoMate	BF017	Schuco	
Evo		2000	BF018
AeroMax	BF018	3000	BF018
SportsNeb	BF018	Sunset	
Super SportsNeb	BF018	NEB100 Series	BF018
Invacare		NEB300 Series	BF018
Passport	BF018		
Envoy	BF018		
Envoy Jr.	BF018		
Select	BF018		
John Bunn			
Nebulite EV	BF018		
LT2	BF018		
LX	BF018		

SUCTION

Suction Machine

Item# **SU100DC**
With Internal Rechargeable Battery

SU100AC
Without Battery

SU100DPA
Includes DC Mobile Power Adapter and Internal Rechargeable Battery



Comes with
Machine
Carry Bag
800cc Suction Canister
AC Adapter & Power Cord
6ft Suction Tubing
3.5in Suction Tube Connector
4.5in Suction Tube Connector
BF1438S Bacteria Filter

- Effective removal of respiratory fluids
- Durable yet lightweight
- Variable vacuum control
- Quiet and easy to use
- Two-year warranty

Accessories and replacement parts

SU100DC-PA	DC Mobile Power Adapter (for car power outlet)
SU100DC-Adapt	Replacement Power Adapter (without cord)
SU100DC-Cord	Replacement Power Cord (without adapter)
SU100DC-BAG	Carrying/Storage Bag
SU100-PA	Car Charger (DC Mobile Power Adapter)
SU100DC-BATTERY	Internal rechargeable battery replacement

Suction Kit for SU100DC

Item# **RES026S-SS**
RES023AW Suction Canister
RES024 Suction Tubing Connector 3.5in
RES024M Suction Tubing Connector 4.5in
BF1438S Bacteria Filter
RES025 Suction Tubing 1/4in x 6ft

HCPCS#
CANISTER - A7000
TUBING - A7002



Suction Canister

Item# **RES023AW**
800cc • Single Use
48/case
HCPCS# A7000
• Float valve shutoff



Suction Filter Component Kit for SU100DC

Item# **RES024-MKIT**
RES024 Suction Tubing Connector 3.5in
RES024M Suction Tubing Connector 4.5in
BF1438S Bacteria Filter



RES026S-SS and RES024-MKIT are compatible with:

Drive/DeVilbiss

	7314P-D
Vacu-Aide® QSU Quiet Suction Unit	7314P-D-EXF 7314D-D
	7305D-D
Vacu-Aide® Suction Unit	7305P-D-EXF 7305D-D-EXF 7305P-D

Sunset

Suction Machine (Portable Unit)	SU100DC
Suction Machine (Stationary Unit)	SU100AC

SUCTION

Suction Kit

Item# **RES026S-MULTI**

RES023AW Suction Canister 800cc
 RES024XL Suction Tube Connector 16in
 RES025 Suction Tubing 6ft x 1/4in
 BF516TS Bacteria Filter
 RES024S Suction Tube Connector 1.5in



Suction Component Kit

Item# **RES024-MULTI**

RES024S Connector Tube 1.5in
 RES024XL Connector Tube 16in
 BF516TS Bacteria Filter



RES026S-MULTI and RES024-MULTI are compatible with:

Precision Medical

Easy Vac	PM60
Power Vac	PM61
Easy Go	PM66 series PM65 PM65E PM65HG

Compass/Roscoe

Roscoe Portable Suction	50004 (AC model) 50006 (DC model)
Cliq Single Cylinder Aspirator	ASP-ROS

Medline

Heavy Duty	HCS7000
------------	---------

Invacare

Aspirator durable suction unit	IRC1135 IRC1136
--------------------------------	-----------------

Drive/DeVilbiss

Heavy-Duty Suction Machine	18600
VacuMax™ Go Suction Machine	18615

Allied Healthcare

Schuco Portable Aspirator with Sturdy Legs	S430A
Schuco Portable Suction Unit with Metal Base	S130A
Schuco Portable Aspirator with Molded Plastic Base	S330A
Gomco OptiVac® AC/DC Portable Suction Unit & 305 Aspirator	G180 G180CE G180CE-JAR G180-JAR 01-22-3005 01-22-0305
Gomco® Tabletop Aspirator Model 300	01-22-0300
Gomco® General Use Aspirators Models 3020 & 3040	01-62-3020 01-62-3040
Gomco® 405 Aspirator	01-12-0405 01-12-4005 01-23-0405
Gomco® Stand-Mounted Models 4032 & 4042	01-52-4032 01-52-4042
Gomco Table Top Gastric Aspirator 270	01-22-0270

SUCTION

Suction Machine Inline Filters

Item# **BF1412**
Final Bacteria Filter
1/4in to 1/2in
Stepped Barb on
Both Sides
10/pack

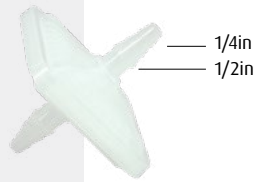

Item# **BF1438S**
1/4in to 3/8in
10/pack



Item# **BF3812**
3/8in to 1/2in
10/pack



Item# **BF1312**
1/3in to 1/2in
1/pack



Item# **BF516TS**
5/16in Barbed with
Threaded NPT
10/pack



Suction Tube Connectors

10/pack

Size	Item#
1.5in	RES024S
3.5in	RES024
4.5in	RES024M
6in	RES024L
10in	RES024L10
16in	RES024XL



Rubber Suction Elbow Connector Drive DeVilbiss Style

Item#
RES028
6/pack



Suction Elbow Connector Precision Medical Style

Item#
RES033
6/pack



Suction Tubing

1/4in

Length	Item#	Qty
18in	RES025S	50/case
6ft	RES025	10/case



3/16in

Length	Item#	Qty
18in	RES025-31618	100/case
20in	RES025-31620	100/case
6ft	RES025-31672	50/case

Bulb Tip Yankauers

Item# **TRAA001S**
Vented • **50/case**

Item# **TRAA002S**
Non-Vented • **50/case**

HCPCS# A4628



- Sterile
- Single patient use
- Not made with natural latex rubber

CLOSED SUCTION

Standard Closed Ventilation Suction System

24 Hour Adult

Endotracheal 540mm

Item#	Description
VEN46001000A	10Fr
VEN46001000AM	10Fr, MDI Port
VEN46001200	12Fr
VEN46001200M	12Fr, MDI Port
VEN46001400	14Fr
VEN46001400M	14Fr, MDI Port
VEN46001600	16Fr
VEN46001600M	16Fr, MDI Port

Tracheostomy 305mm

Item#	Description
VEN46011000A	10Fr
VEN46011000AM	10Fr, MDI Port
VEN46011200	12Fr
VEN46011200M	12Fr, MDI Port
VEN46011400	14Fr
VEN46011400M	14Fr, MDI Port
VEN46011600	16Fr
VEN46011600M	16Fr, MDI Port

72 Hour Adult

Endotracheal 540mm

Item#	Description
VEN56051000A	10Fr
VEN56051000AM	10Fr, MDI Port
VEN56051200	12Fr
VEN56051200M	12Fr, MDI Port
VEN56051400	14Fr
VEN56051400M	14Fr, MDI Port
VEN56051600	16Fr
VEN56051600M	16Fr, MDI Port

Tracheostomy 305mm

Item#	Description
VEN56061000A	10Fr
VEN56061000AM	10Fr, MDI Port
VEN56061200	12Fr
VEN56061200M	12Fr, MDI Port
VEN56061400	14Fr
VEN56061400M	14Fr, MDI Port
VEN56061600	16Fr
VEN56061600M	16Fr, MDI Port

Isolation Valve

- Safe and simple access for mechanically ventilated patients
- Designed for 72 hours of continuous use

Black Ring Indicator

- Ensures that the catheter is properly withdrawn from the ET or Trach device
- Black ring must be visible in the plastic sheath after suctioning the patient

Catheter Tip

- Atraumatic and rounded for minimal tracheal wall injury

ISO Color Coded

- For instant recognition of catheter sizes

Neonatal/Pediatric

With Y-Adapter

Item#	Description
VEN66000500	305mm, 5Fr
VEN66000600	305mm, 6Fr
VEN66000700	305mm, 7Fr
VEN66000800	305mm, 8Fr
VEN66001000	405mm, 10Fr
VEN66000500M	305mm, 5Fr, MDI Port
VEN66000600M	305mm, 6Fr, MDI Port
VEN66000700M	305mm, 7Fr, MDI Port
VEN66000800M	305mm, 8Fr, MDI Port
VEN66001000M	405mm, 10Fr, MDI Port

NEW

With DSE Connection

Item#	Description
VENCSS6-305	6Fr, 305mm
VENCSS8-203	8Fr, 203mm
VENCSS8-355	8Fr, 355mm
VENCSS10-203	10Fr, 203mm
VENCSS10-405	10Fr, 405mm

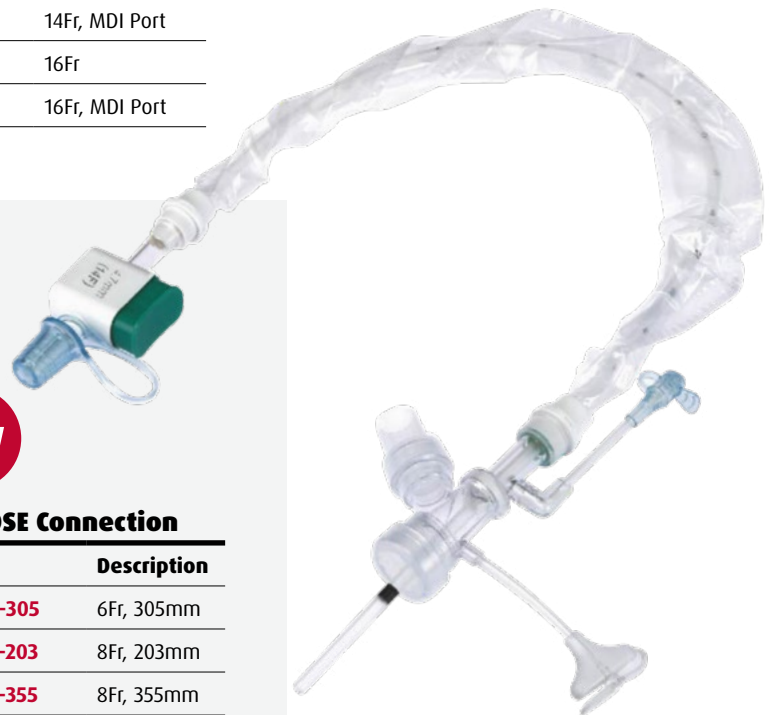

CLOSED SUCTION

Deluxe Closed Ventilation Suction System



One-handed operation

24 Hour Adult

Endotracheal 540mm

Item#	Description
VEN160100A	10Fr
VEN160100AM	10Fr, MDI Port
VEN160120	12Fr
VEN160120M	12Fr, MDI Port
VEN160140	14Fr
VEN160140M	14Fr, MDI Port
VEN160160	16Fr
VEN160160M	16Fr, MDI Port

With Wedge + Adapter

Item#	Description
VEN162100A	10Fr
VEN162100AM	10Fr, MDI Port
VEN162120	12Fr
VEN162120M	12Fr, MDI Port
VEN162140	14Fr
VEN162140M	14Fr, MDI Port
VEN162160	16Fr
VEN162160M	16Fr, MDI Port

Tracheostomy 305mm

Item#	Description
VEN161100A	10Fr
VEN161100AM	10Fr, MDI Port
VEN161120	12Fr
VEN161140	14Fr
VEN161160	16Fr
VEN161160M	16Fr, MDI Port

With Wedge + Adapter

Item#	Description
VEN163100A	10Fr
VEN163100AM	10Fr, MDI Port
VEN163120	12Fr
VEN163140	14Fr
VEN163160	16Fr

72 Hour Adult

Endotracheal 540mm

Item#	Description
VEN365100A	10Fr
VEN365100AM	10Fr, MDI Port
VEN365120	12Fr
VEN365120M	12Fr, MDI Port
VEN365140	14Fr
VEN365140M	14Fr, MDI Port
VEN365160	16Fr
VEN365160M	16Fr, MDI Port

With Wedge + Adapter

Item#	Description
VEN367100A	10Fr
VEN367100AM	10Fr, MDI Port
VEN367120	12Fr
VEN367120M	12Fr, MDI Port
VEN367140	14Fr
VEN367140M	14Fr, MDI Port
VEN367160	16Fr
VEN367160M	16Fr, MDI Port

Tracheostomy 305mm

Item#	Description
VEN366100A	10Fr
VEN366100AM	10Fr, MDI Port
VEN366120	12Fr
VEN366120M	12Fr, MDI Port
VEN366140	14Fr
VEN366140M	14Fr, MDI Port
VEN366160	16Fr
VEN366160M	16Fr, MDI Port

With Wedge + Adapter

Item#	Description
VEN368100A	10Fr
VEN368100AM	10Fr, MDI Port
VEN368120	12Fr
VEN368120M	12Fr, MDI Port
VEN368140	14Fr
VEN368140M	14Fr, MDI Port
VEN368160	16Fr
VEN368160M	16Fr, MDI Port

Suction Control Switch

- Quick and easy
- Single handed operation allows the free hand to support the ET or Trach device to ensure less trauma

Catheter Tip

- Atraumatic and rounded for minimal tracheal wall injury

MDI Port

- Large and easy to grip port allows for rapid medication introduction

Irrigation Port

- One-way valve prevents backflow leakage
- Easy access for cleaning

Isolation Valve

- Seals the irrigation chamber for better catheter cleaning
- Allows for continuous ventilation and prevents backflow of saline during cleaning

Black Ring Indicator

- Ensures that the catheter is properly withdrawn from the ET or Trach device
- Black ring must be visible in the plastic sheath after suctioning the patient

Neonatal/Pediatric

Item#	Description
VEN26000500	305mm, 5Fr
VEN26000500M	305mm, 5Fr, MDI Port
VEN26000600	305mm, 6Fr
VEN26000600M	305mm, 6Fr, MDI Port
VEN26000700	305mm, 7Fr
VEN26000700M	305mm, 7Fr, MDI Port
VEN26000800	305mm, 8Fr
VEN26000800M	305mm, 8Fr, MDI Port
VEN26001000	405mm, 10Fr
VEN26001000M	405mm, 10Fr, MDI Port



TRACHEOSTOMY

Tracheostomy Mask

Item#
RES2130
Adult Size
50/case



HCPCS# A7525

RES2230
Pediatric Size
50/case

- Latex-free
- 360° swivel in 2 places allows access from either side of the patient
- Comes with removable adapter to fit with aerosol or O₂ supply tubing

Adapter for T-HME

Item# **RES027A**
Each



Flexible Trach Adapter

Item#
TRAA003
22mm Cuff
Each



Comparable to
OEM# 1073902, 1147898

NEW

Tracheostomy Ties with Fastener Tabs

20/case

One-piece • Easy on

Item#
RES029P-11
Pediatric 2.5x30cm (11.5in)

RES029-17
Adult 2.5x43cm (17in)

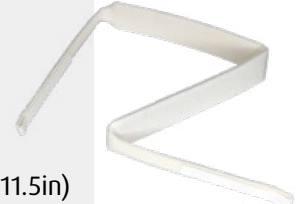

• Designed to provide secure stabilization of the tracheostomy tube

Two-piece • Easy off

Item#
RES030P-10
Pediatric 2x25.5cm (10in)

RES030P-14
Pediatric 2x35.5cm (14in)

RES030P-18
Pediatric 2x45.5cm (18in)

RES030-20
Adult 2.5x51cm (20in)

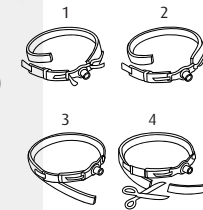
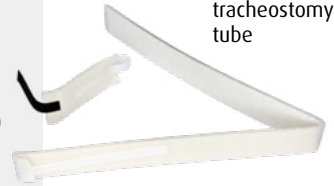

Adult Flexible Connector

Item#
TRAA004
22/15mm x 15mm
Length 4.9-7.5cm
50/case

NEW



Comparable to OEM# 3222

HMEs

Heat Moisture Exchangers

30/case (RES027FLEX 40/case. RES027UOP 50/case.)



NEW

	RES027FLEX Flex HME — Foam	RES027 T-HME	RES027IL Inline HME — Large Volume	RES027NE Inline HME — Neonatal	RES027OP T-HME with O2 Port	RES027UOP HME with O2 Port Comparable to OEM# 1190
TV Range (mL)	300-1500	250-1000	50-250	15-50	250-1000	50-1000
Moisture Output (mg H₂O/L)	33 mg/L	30, Vt = 0.1L	31, Vt = 0.1L	30 mg/L		13.2 mg/L
Weight (g)	17	4.5	10	4.5	7	5
Resistance (cm H₂O)	0.5 @ 30 LPM 1.34 @ 60 LPM	0.32 @ 30 LPM 0.81 @ 60 LPM 1.62 @ 90 LPM	0.4 @ 10 LPM	0.5 @ 10 LPM	0.4 @ 30 LPM 0.9 @ 60 LPM 1.5 @ 90 LPM	0.4 @ 30 LPM 0.9 @ 60 LPM 1.5 @ 90 LPM
Dead Space (mL)	75	12.5	13	2.5	12	17
Connection (mm)	22M,15F	15F	15M,22M/15F	15M,15F	15F 5.5mm O2 port	15F

VENTILATOR FILTERS, MASKS, AND CONNECTORS

NIV Mask with Headgear — Non-vented

Each

Item#

CM038M Medium

CM038L Large



- Disposable, single patient use
- PC frame with PVC air cushion seal
- Low dead space for low CO2 buildup
- Clear mask allows a good view of mouth and nasal area
- Headgear with Velcro fasteners provide maximum versatility and movement
- Dual 360 degree swivels at the mask attachment and at the standard 22mm tubing attachment point

Inline Bacterial Viral Filter for CPAP/BIPAP/Vent Units

Item#

BF2200

22mm

5/pack



Attach between the machine and tube for additional protection against bacteria and allergens

Valved T-Adapter — Adult

Item# **VEN001**

22F-18F-22M/15F

Each



Reusable Filter for Respironics Trilogy

Item# **CF1009F**

2/pack

OEM# 1029330

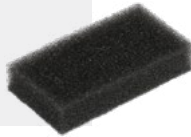

Air Inlet Vent Filter for Philips Respironics V60

Item# **VF002**

For use with Philips Respironics V60

5/pack



Ventilator Felt Filter

Item# **VF006**

For use with NPB LP6 & LP10

10/pack

OEM# L-002917-000



NEW

Reusable Filter for Respironics Trilogy EV300

Item# **VF007**

For use with EV300

1/pack • 10/pack

OEM# 1134591



NEW

Filters for Löwenstein LUISA

Item# **VF008-12**

Disposable filter

12/pack

OEM# WM29652



NEW

Item# **VF008F-2**

Reusable Filter

2/pack

OEM# WM29928



Proximal Inline Filter for Newport HT50

Item# **VF009-5**

5/pack



NEW

Circuit Connectors

Item# **RES013**

15mm ID x 22mm OD

10/pack



RES014

22mm OD x 22mm OD

10/pack



Swivel Connector Silencer

Item# **VEN002**

For Ventilator Circuits and CPAP

Each



Fixed Exhalation Port

Item# **VEN003**

For Ventilator Circuits and CPAP

22 mm OD x 15 mm ID

Each

Comparable OEM# 312149



VENTILATOR CIRCUITS WITHOUT HUMIDIFIER CHAMBER

Passive Heated Breathing Circuit

Item#
VC1114
For use with MR850 Humidifier
10/case
OEM# RT114

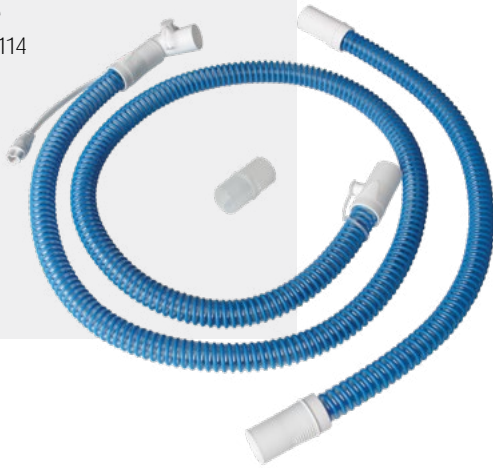

Passive Non-Heated Breathing Circuits

For use with Respiration Trilogy

Item#
VC1000
With swivel exhalation port
Each
OEM# 1073228 & 1073236



VC1100
With fixed exhalation port
Each
OEM# 1069467 & 1069468

Passive Circuit w/Exhalation Port and Bacterial/Viral Filter

Item#
VC1005
Includes 19mm tube
with 22mm cuffs
Each

VC1005P
Includes 15mm tube
with 22mm cuffs
Each



Comparable to OEM#
1147378, 1132340, 7615

Cough Assist Kits

All kits come with
1 BF2200 Bacterial/Viral Filter
and 1 RES013 Circuit Connector

Item#
CAKIT001
With 1 TUB06 6ft Tube
Each
OEM# 1090835



CAKIT002
With 1 TUB06 6ft Tube
and 1 RES019 Oxygen
Enrichment Adapter
Each



CAKIT003
With 1 TUB06 6ft
Tube and 1 TRAA003
Flexible Trach Adapter
Each



NEW

CAKIT004
With 1 TUB06 6ft Tube and
1 SBC01 Series Breathing Mask

CAKIT005
With 1 TUB04 4ft Tube and
1 SBC01 Series Breathing Mask
Each



Available SBC01 Mask Sizes:

- Infant
- Toddler
- Adult Small
- Adult Medium
- Adult Large

CAKIT006
with 1 CAMP001 Mouthpiece
and 1 TUB06 6ft Tube
Each
Comparable to OEM# 1090836



NEW

VENTILATOR CIRCUITS WITHOUT HUMIDIFIER CHAMBER

Non-Heated Breathing Circuits

For use with Respiration Trilogy
22mm cuffs
30/case

Item#	OEM#	Mode	Water Trap	Size	Tube Diameter
VC1001	1073223 & 1073232	Active	No	Adult	22mm
VC1001P	1073220 & 1073229	Active	Yes	Pediatric	15mm
VC1004	1069443 & 1069444	Passive	Yes	Adult	22mm
VC1004P	1073224 & 1073233	Passive	Yes	Pediatric	15mm

Item#
VC1001
Active Adult
OEM#
1073223
1073232

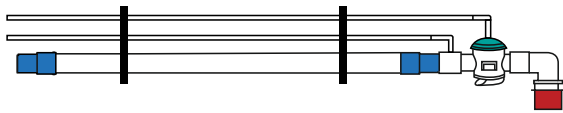
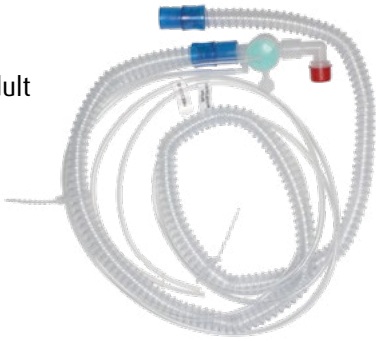

Item#
VC1001P
Active Pediatric
OEM#
1073220
1073229

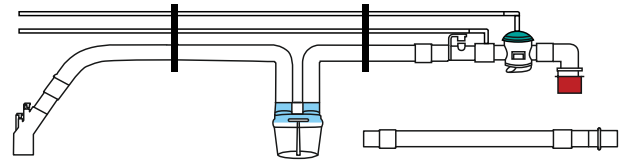
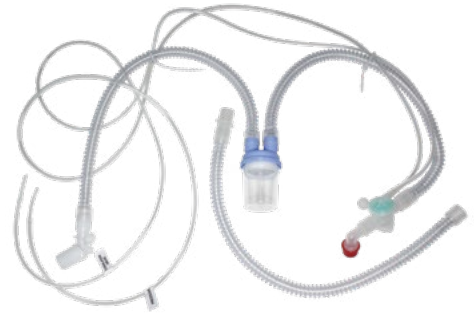

To use active circuits with Respiration Trilogy, simply cut ends off pressure and exhalation lines.

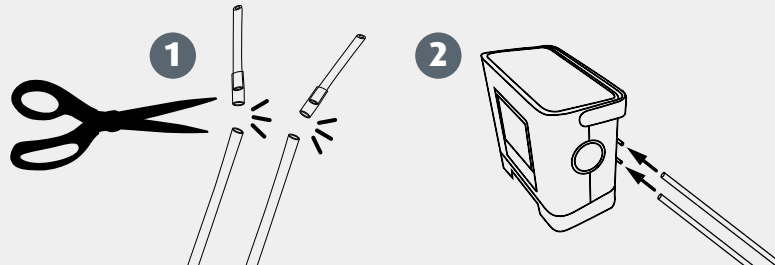

Item#
VC1004
Passive Adult
OEM#
1069443
1069444

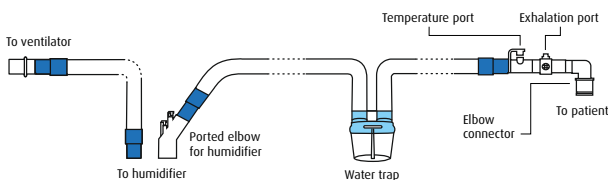

Item#
VC1004P
Passive Pediatric
OEM#
1073224
1073233

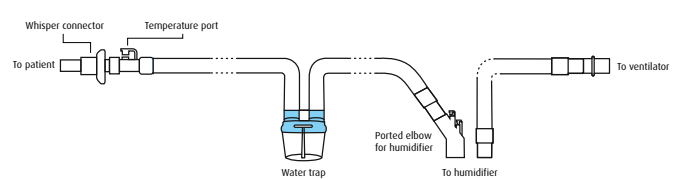

STRONGARM

STRONGARM

StrongArm® Comfort Cane



- Ergonomic handgrip supports forearm and relieves pressure from wrist
- Offset bend centers grip over tip for maximum stability when cane is at the user's side
- Lightweight & strong
- 12 height adjustments
- Comfort Fit Handle
- Supports up to 500 lbs
- For left & right arm
- Self-standing base: Larger 'footprint' greatly improves traction and overall stability
- Safely supports user walking on grass, gravel, sand, carpet, hard surfaces, and stairs

10/case

Item#	Color
BM001	Black
BM001-BL	Blue
BM001-PR	Purple

Color pack (one of each)

BM001-3MC



Now comes in retail packaging

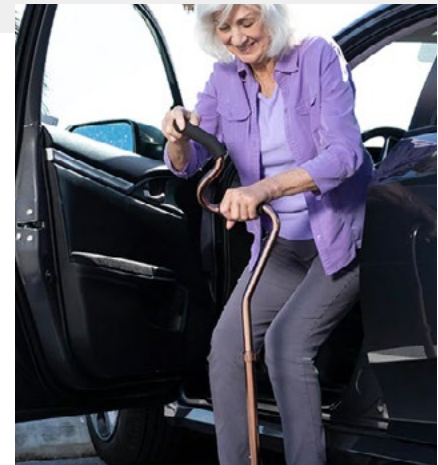

StrongArm® Grabber Reacher Tool

Item#
BM002

Your ultimate companion for effortless grabbing and reaching! Engineered with precision and designed for practicality, this innovative tool is perfect for those hard-to-reach items and provides extra support for heavier items. Grab with Ease and Confidence in Each Squeeze.

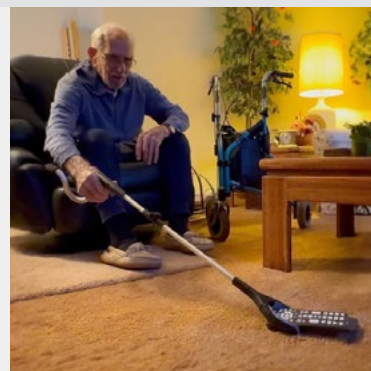

- Transfers weight for improved support
- Rotating jaw for vertical or horizontal use
- Integrated hook and magnetic retriever
- Durable, lightweight aluminum construction
- Folds for easy storage and portability
- 32" of added reach

BATH SAFETY

PreserveTech™ 360° Swivel Bath Chair

Item#
BSE001

Compact and customizable, the PreserveTech™ Swivel Bath Chair provides a safe transfer in and out of the tub for those with limited mobility. The seat rotates a full 360° in either direction and automatically locks at 90° intervals to help prevent skin irritation and friction wounds during transfers. The seat height can be adjusted from 15"–22", and the padded armrests can be raised out of the way.



Splash Defense™ Transfer Bench

Item#
BSE002

Splash Defense™ Transfer Bench is the first of its kind to allow the shower curtain liner to remain inside the bath tub while a user is bathing. This unique product enhancement is essential to help prevent water from spilling out onto the bathroom floor, creating a danger zone for users and caretakers. The Splash Defense™ Transfer Bench provides security for the caretaker, while giving users back their independence and allowing them to bathe safely and privately again.



PreserveTech™ 360° Universal Raised Toilet Seat

Item#
BSE003

Introducing the PreserveTech™ Universal Raised Toilet Seat. With our first ever, truly universal raised toilet seat users can set three different seat heights (2, 4 or 6") by maneuvering just two components. This seat can fit on most standard and elongated toilets and features two hygienic cutaways for easy cleaning. The pivoting armrests can be raised or removed, depending on user needs and bathroom space. This item also includes a lid with a recessed grip for effortless opening.



Visit www.sunsethcs.com

MATERNITY

Motif Twist Double Electric Breast Pump

Item#
MAT2300T1

Motif Twist is a convenient, portable option for every mom. This pump is lightweight and simple to use with a quiet motor. The Twist is battery-powered with AA batteries, making it a great option for moms on-the-go. Simply twist the knob to select different suction and massage settings and use the green LED light timer to track pumping sessions. Includes a storage bag and bottle stands.

- Expression Mode: Works to express milk from the breast as efficiently as possible
- Closed System: Backflow prevention keeps the motor clean, preventing contamination
- Lightweight: Weighs 0.7 lb. — perfect for portability
- Massage Mode: Helps stimulate let-down by mimicking a baby's nursing pattern
- Dual Power Options: Allows you to pump stationary or on battery power with AA batteries
- Quiet Motor: 45 dB hum making this a discreet option for moms



Motif Luna Double Electric Breast Pump

Item#
MATAAA0013

NEW

Sophisticated, strong, and soothing, the Motif Luna is Motif's most powerful breast pump. With a battery life of 2+ hours between charges, the Luna was built for modern motherhood. The Luna is available in both battery and non-battery versions. Lightweight and portable, the Luna weighs less than 2 pounds. With a suction strength of 280 mmHg, the Luna is proven to provide More Milk in Less Time®.

- Very quiet
- Customizable pumping sessions
- Compact size and light weight
- Less guilt, pain, & anxiety
- Convenient nightlight & digital screen



MATERNITY

Motif Milk Storage Bags

Designed to make breastmilk storage as simple as possible, these bags feature an easy-pour spout for a no-mess experience. Easily transfer milk from the bottle to the bag, seal with the leak-proof double zipper lock, label, and store in your fridge or freezer. No spills. No hassle. Made with your busy day in mind. Comes in a box of 40, 90, 100 or 300 count.

HCPCS: K1005

Item#
MATAAC000806
100/pack

Other pack counts are available.
Ask your rep for details.

NEW



- Easy-pour spout design
- BPA-free
- Leak-proof with double zipper lock
- Stores up to 8 oz. of milk
- Write-on label
- Freezer safe
- Lays flat for compact freezer storage
- Self stand for refrigerator storage

Motif BiliTouch™ Phototherapy Blanket

Item#
MAT2300EAB

Motif BiliTouch™ Phototherapy Blanket
with Hard Case
Each

MAT2300EAB-W

Motif BiliTouch™ Phototherapy Blanket with
Hard Case and 2-Year Extended Warranty
Each

Motif BiliTouch™ Disposable Covers

MAT2300EAB-DC
25/case

Motif Phototherapy Eye Shield
25/box

Size	Item#
Small	MAT2300ES-S
Large	MAT2300ES-L



- Convenient, ultra-portable phototherapy treatment with battery-powered option
- Patient-centered, lightweight design facilitates bonding with newborn infant
- LED light source, no fiber optic cables for easy positioning

The Motif BiliTouch™ phototherapy blanket is a biliblanket designed by healthcare professionals to treat newborn infants diagnosed with jaundice (hyperbilirubinemia). This portable, convenient phototherapy treatment device allows your patients to continue to hold, feed, and care for their baby while reducing high bilirubin levels at home.

Visit www.sunsethcs.com

WOUND CARE

ZeniFOAM

Polyurethane Foam Wound Dressing
10/box

NEW

ZeniFoam is an absorbent, non-adherent sterile polyurethane foam dressing used to absorb moderate to heavy wound drainage to protect sensitive and fragile skin. ZeniFOAM is conformable with a colored waterproof backing to prevent strike through drainage and provide protection from external contaminants.



Item#	Size
WC10022	2" x 2"
WC10045	4" x 5"
WC10066	6" x 6"
WC10088	8" x 8"

ZeniFOAM GENTLE

Polyurethane Foam Wound Dressing with Silicone Adhesive, No Border
10/box

NEW

ZeniFOAM GENTLE is a sterile, silicone-faced, polyurethane foam dressing without an adhesive border designed to absorb moderate to heavy wound drainage. ZeniFOAM GENTLE provides maximum absorption while protecting sensitive or fragile skin and reduction of painful dressing changes.



Item#	Size
WC20022	2" x 2"
WC20044	4" x 4"
WC20066	6" x 6"

ZeniFOAM GENTLE BORDER

Polyurethane Foam Wound Dressing with Silicone Adhesive and Border
10/box

NEW

ZeniFOAM GENTLE BORDER is a sterile, siliconefaced, polyurethane foam dressing with a silicone adhesive border designed to absorb moderate to heavy wound drainage. ZeniFOAM GENTLE BORDER is a multi-layered dressing that provides maximum absorption while protecting sensitive or fragile skin and reducing painful dressing changes.



Item#	Size
WC30000H	Heel
WC30022	2" x 2"
WC30033	3" x 3"
WC30044	4" x 4"
WC30066	6" x 6"
WC30077S	Sacral 7" x 7"
WC30099S	Sacral 9" x 9"

ZeniPAD PLUS

Multi-Layer Composite Dressing
10/box

NEW

ZeniPAD PLUS is a sterile, multi-layered, waterproof composite wound dressing used for absorption on minimal to moderately draining wounds. It has multiple layers comprised of a non-adherent contact layer, a non-woven pad for absorption, a breathable polyurethane barrier film and a conformable adhesive fabric tape.



Item#	Size
WC40022	2" x 2"
WC40044	4" x 4"
WC40066	6" x 6"
WC400410	4" x 10"

WOUND CARE

ZeniPLAST

Hydrocolloid Wound Dressing 10/box

NEW

ZeniPLAST is a sterile, hydrocolloid wound dressing used to help maintain an optimal moist wound environment conducive to wound healing. ZeniPLAST interacts with wound exudate to form a soft gel which helps to protect and prevent damage to newly formed tissue during dressing removal.



Item#	Size
WC50022	2" x 2"
WC50044	4" x 4"
WC50066	6" x 6"

ZeniFIBER

Calcium Alginate Wound Dressing 10/box

NEW

ZeniFIBER is a sterile, non-woven pad or rope made from calcium alginate fibers. Upon contact with wound exudate, ZeniFIBER becomes a fibrous gel that helps to maintain a moist wound environment that is conducive to wound healing.



Item#	Size
WC60022	2" x 2"
WC60045	4" x 5"
WC60066-Rope	6" Rope
WC60066	6" x 6"
WC60088	8" x 8"

ZeniCONTACT

Silicone Wound Contact Dressing 10/box

NEW

ZeniCONTACT is a sterile, open mesh, soft silicone wound contact layer that allows exudate to pass through to the secondary dressing. The silicone is gentle and non-adherent to the wound while preventing secondary dressings from adhering to fragile tissue. ZeniCONTACT dressings can be used as topical ointment carriers or in conjunction with negative pressure wound therapy.

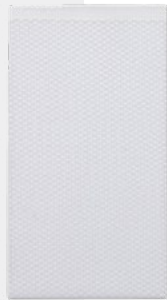

Item#	Size
WC70047	4" x 7"

ZeniABSORB

Super Absorbent Dressings 10/box

NEW

ZeniABSORB is a sterile dressing for use on heavily exuding wounds, consistent of an oxygen permeable, waterproof nonwoven layer, a super absorbent pad layer and hydro-penetrating nonwoven layer. The layered construction facilitates fluid management to provide the optimal moist wound environment and locks in exudate for maximum absorption.

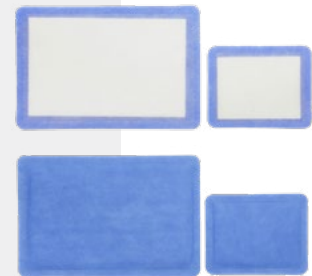

Item#	Size
WC80045	4" x 5"
WC80069	6" x 9"

WOUND CARE

ZeniCOL

Bovine Collagen Dressing and Powder
10/box

NEW

ZeniCOL is a high quality, sterile, non-hydrolyzed pure collagen dressing composed from 100% native bovine origin. Collagen is used to promote angiogenesis, decrease MMP levels in chronic wounds, stimulate collagen deposition and formation of granulation tissue in the wound.



Item#	Size
WC90022	2" x 2"
WC90044	4" x 4"
WC9001GP	Powder - 1 gram

ZeniCOL Ag

Collagen Matrix Dressing with Silver
10/box

NEW

ZeniCOL Ag Collagen Dressing with Silver is an advanced wound care dressing made of animal derived collagen, sodium alginate, carboxymethylcellulose (CMC), ethylenediaminetetraacetic acid (EDTA) and silver chloride. The topically applied wound dressing transforms into a soft gel sheet when in contact with wound exudate to maintain a moist wound environment that aids in the formation of granulation tissue and epithelialization and removes zinc to inhibit the activity of MMPs. The silver chloride in the dressing is an effective antimicrobial intended to prevent colonization of the dressing.



Item#	Size
WC90022AG	2" x 2"
WC90044AG	4" x 4"

ZeniFOAM Ag

Foam Wound Dressings with Silver
10/box

NEW

ZeniFOAM Ag is a highly absorbent, non-adherent, conformable foam dressing without an adhesive border used for the management of moderately to heavily draining wounds. Each dressing contains 0.35-0.40mg/cm² ionic silver as the active component to provide an optimal moist wound healing environment combined with effective antibacterial activity and exudate management.

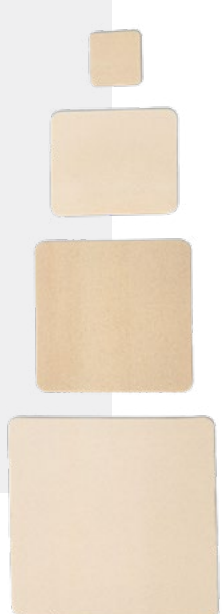

Item#	Size
WC10022AG	2" x 2"
WC10045AG	4" x 5"
WC10066AG	6" x 6"
WC10088AG	8" x 8"

ZeniFOAM Ag GENTLE

Foam Dressings with Silver
10/box

NEW

ZeniFOAM Ag GENTLE is a sterile, silver impregnated, silicone-faced, polyurethane foam dressing without an adhesive border designed to absorb moderate to heavy wound drainage. ZeniFOAM Ag GENTLE provides maximum absorption while protecting sensitive or fragile skin and reducing painful dressing changes. ZeniFOAM Ag GENTLE contains 0.25-0.35mg/cm² of silver ions and has been shown to have antibacterial effectiveness for up to 7 days, as demonstrated in vitro.



Item#	Size
WC20044AG	4" x 4"

WOUND CARE

ZeniFOAM Ag GENTLE BORDER

Silver, Silicone Foam Dressings with Adhesive Border
10/box



ZeniFOAM Ag GENTLE BORDER is a sterile, siliconefaced, polyurethane foam dressing with a silicone adhesive border designed to absorb moderate to heavy wound drainage. ZeniFOAM Ag GENTLE BORDER contains 0.25-0.35mg/cm³ of silver ions and has been shown to have antibacterial effectiveness for up to 7 days, as demonstrated in vitro. ZeniFOAM Ag GENTLE BORDER is a multi-layered dressing that provides maximum absorption while protecting sensitive or fragile skin and reducing painful dressing changes.



Item#	Size
WC30044AG	4" x 4"
WC30066AG	6" x 6"

ZeniFIBER Ag

Calcium Alginate with Silver
10/box



ZeniFIBER Ag is a silver alginate dressing composed of natural fibers from seaweed combined with silver to provide exudate control and reduction of bacterial growth in the dressing while maintaining a moist environment and reducing wound odor.



Item#	Size
WC60012AGR	12" Rope
WC60022AG	2" x 2"
WC60045AG	4" x 5"
WC60066AG	6" x 6"
WC60088AG	8" x 8"

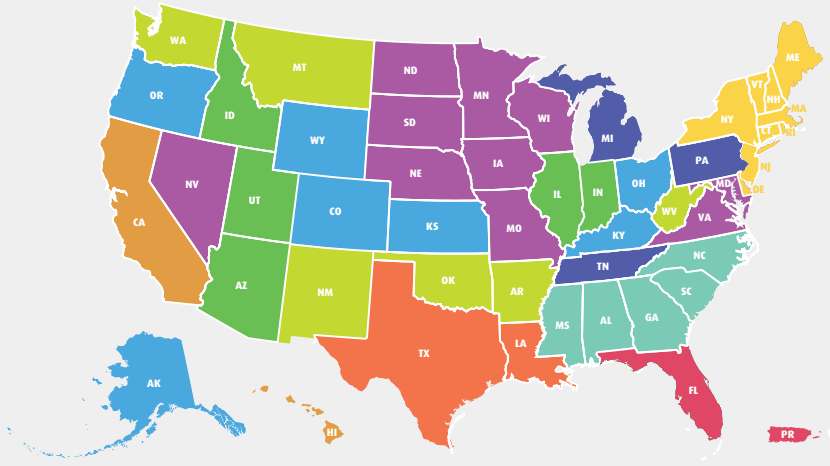

Connect with us



Your sales representatives



Sean O'Donnell

Direct 312-637-6558
Ext 558
Email sodonnell@sunsethcs.com



Brian Lipson

Direct 312-533-2463
Ext 217
Email blipton@sunsethcs.com



Madison Gwilliam

Direct 312-533-2459
Ext 224
Email mgwilliam@sunsethcs.com



Jonny Deutsch

Direct 872-259-3691
Ext 691
Email jdeutsch@sunsethcs.com



Sam Powers

Direct 872-258-1651
Ext 876
Email spowers@sunsethcs.com



Michelle Chojnacki

Direct 312-533-2486
Ext 234
Email mchojnacki@sunsethcs.com



John Bisceglie

Direct 312-533-2462
Ext 205
Email jbisceglie@sunsethcs.com



Chris Crawford

Direct 872-258-1650
Ext 210
Email ccrawford@sunsethcs.com



Jon Kmiec

Direct 312-533-2482
Ext 234
Email jkmiec@sunsethcs.com



Pavle Pantovic

Direct 872-282-0751
Ext 903
Email ppantovic@sunsethcs.com



Phil Cosens

Direct 312-533-2470
Ext 219
Email pcosens@sunsethcs.com



Danielle Dubowski

Direct 312-533-2479
Ext 231
Email ddubowski@sunsethcs.com



Phone 877-578-6738
Fax 312-997-9985
Email sales@sunsethcs.com
Visit www.sunsethcs.com

Corporate Headquarters
141 W Jackson Blvd Ste 1950
Chicago IL 60604

Central Distribution Center
2725 Alft Ln
Elgin, IL 60124

Western Distribution Center
6750 W Van Buren St Ste 100
Phoenix, AZ 85043

National Accounts



Nikki Drake

Direct 312-533-2469
Ext 218
Email ndrake@sunsethcs.com



Gabrielle Barruzza

Direct 312-638-8680
Ext 680
Email gbarruzza@sunsethcs.com