

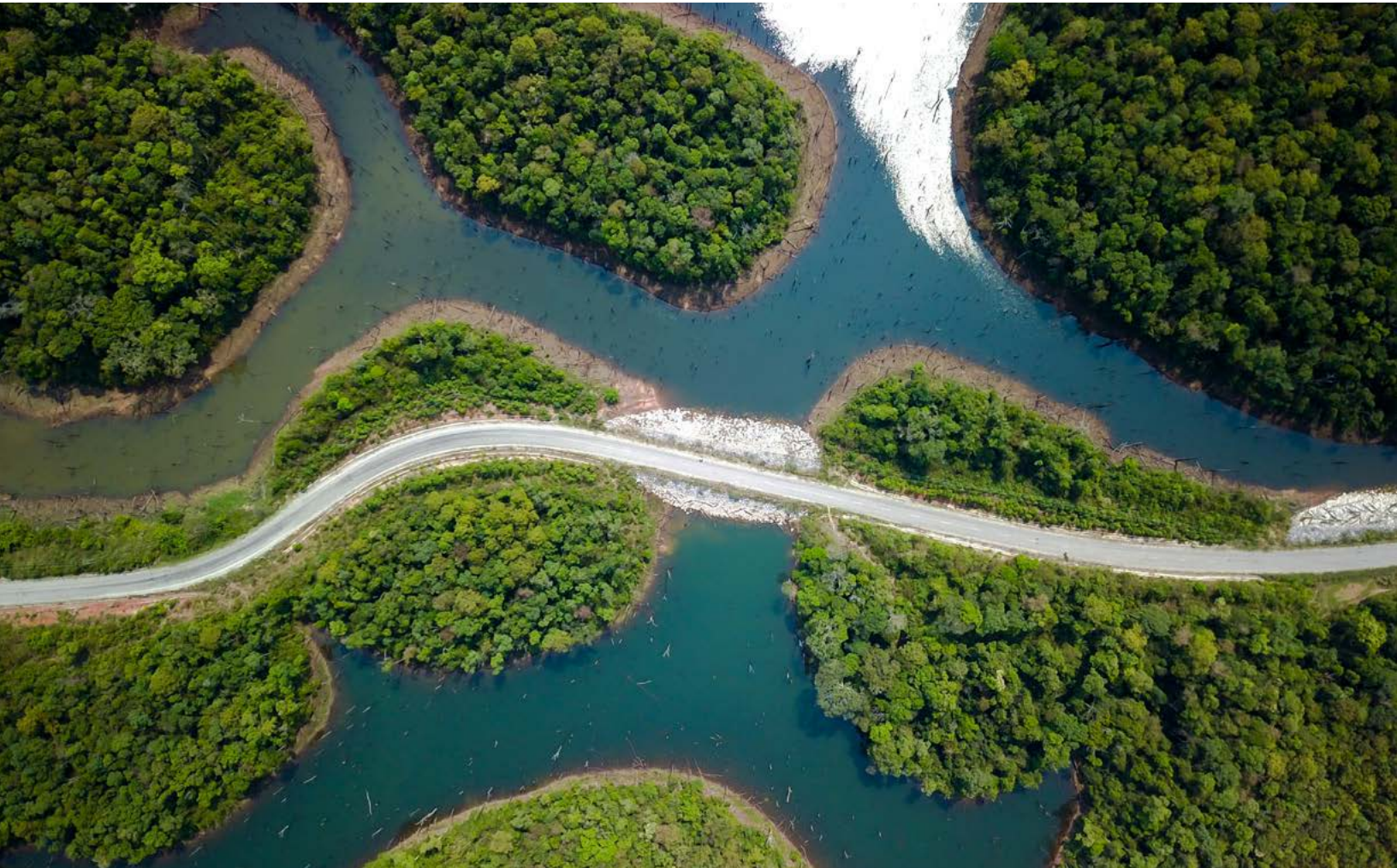

Acute Care

Product Catalog



Contracted Supplier



vizient.
Awarded Supplier





Sales Representatives



Egle Sventnickaite
872-258-1654
esventnickaite@sunsethcs.com



Mason Moss
262-788-1862
mmoss@sunsethcs.com



Owen Ruth
312-533-2451
owenr@sunsethcs.com



Cindy Geighes
312-533-2478
cgeighes@sunsethcs.com



Hunter Baudino
262-788-1855
hbaudino@sunsethcs.com



Wyatt Kanemoto
262-788-8941
wkanemoto@sunsethcs.com



Director, Strategic Accounts
Lisa Iannazzone RN, BSN
636-222-3134
lisa@sunsethcs.com



Contract Manager, Strategic Accounts
Gina Rosenberg
914-837-5215
grosenberg@sunsethcs.com



Manager, Product & Business Development
Tom Munar
312-533-2476
tmunar@sunsethcs.com



RRT Clinical Specialist
Krystle Bodine BS, RRT
kbodine@sunsethcs.com

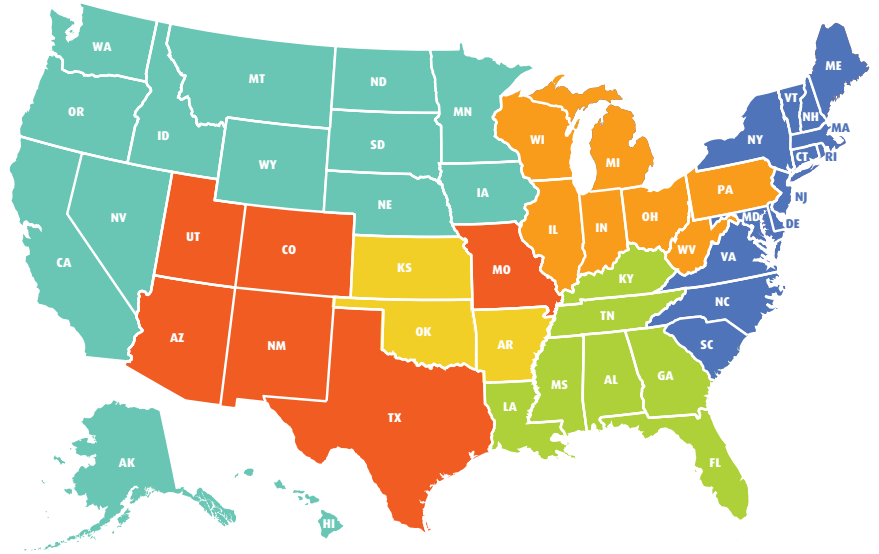

Corporate Office

Phone 872-275-3210

Fax 312-997-9985

141 W Jackson Blvd Ste 1950
Chicago IL 60604

Central Returns/Distribution Center

2725 Alft Ln
Elgin IL 60124

West Returns/Distribution Center

6750 W Van Buren St
Phoenix AZ 85043

Content

| NIV | Page |
|----------------------|-------------|
| Adult NIV Masks | 4-9 |
| Pediatric NIV Masks | 6-9 |
| CPAP Tubing | 10 |
| Connectors and Ports | 10 |
| Headgear | 11 |
| Chinstraps | 11-12 |

| Microdial Flowmeter | Page |
|----------------------------|-------------|
| Microflow | 13 |

| Respiratory Disposables | Page |
|-----------------------------------|-------------|
| Vent Circuits | 14-17 |
| Lynx Venturi Oxygen Delivery | 18 |
| Oxygen Masks | 19-20 |
| Air Entrainment Masks | 20 |
| Oxygen Cannula and Accessories | 21-23 |
| Oxygen Supply and CPAP Tubing | 24 |
| Firesafe | 25 |
| Oxygen Connectors and Adapters | 26 |
| Oxygen Accessories | 27 |
| SpO2 Sensors | 28 |
| Bacteria Filters and Humidifiers | 29-30 |
| Oxygen Filters | 30-31 |
| Spirometers | 32 |
| Drainage Bags | 32 |
| Concentrator Filters | 33-34 |
| Berman Airways | 35 |
| Guedel and Nasopharyngeal Airways | 36 |
| Tracheostomy Kits and Accessories | 36 |
| HMEs and HME Accessories | 37 |

| Open Suction | Page |
|---|-------------|
| Suction Catheter Kits | 38 |
| Suction Catheters | 39 |
| Trach Ties and Connectors | 39 |
| Suction Canisters and Liners | 40 |
| Suction Canister/Liner Kits | 41 |
| Suction Canister Brackets and Wall Mounts | 42 |
| Suction Tubing, Yankauers, and Bulk Roll | 43 |
| Solidifiers | 44 |



| Medication Delivery | Page |
|-------------------------------|-------------|
| Inhaler Chambers | 45 |
| Peak Flow Meters | 45 |
| Intake Filters and T-Adapters | 45 |
| Compressor Nebulizers | 46 |
| Handheld and Mini Nebulizers | 46 |
| Nebulizer Kits | 47 |
| Aerosol Masks | 47 |

| Closed Suction Catheters | Page |
|---------------------------------|-------------|
| Standard Switch | 48-49 |
| Deluxe Switch | 50-51 |

| Resuscitation Devices | Page |
|------------------------------|-------------|
| Resuscitators | 52 |
| Manometers | 53 |
| PEEP Valves | 53 |
| Reservoir Bags | 54 |
| Pocket Resuscitator Set | 54 |
| Breathing Masks | 54 |

| Laryngeal Masks | Page |
|------------------------------|-------------|
| Silicone Disposable | 55 |
| Silicone Reusable | 55 |
| Flexible Silicone Disposable | 55 |
| Flexible Silicone Reusable | 55 |
| PVC Disposable | 56 |
| Flexible PVC Disposable | 56 |

| Anesthesia | Page |
|-------------------|-------------|
| PeDIA | 57 |

| vizient Awarded Supplier | CONTRACT |
|------------------------------------|--|
| MS1087 | Active Humidification + Respiratory Disposables |
| MS1097 | Medication Delivery |
| MS1049 | Non-Invasive Ventilation |
| MS7709 | PeDIA Anesthesia Induction |
| MS1486 | Open Suction |
| MS1488 | Closed Suction Catheters |

PREMIER | **Contracted Supplier**

| CONTRACT | |
|-----------------|---------------------------------------|
| PP-NS-1741 | Respiratory Disposables |
| PP-NS-1753 | Medication Delivery |
| PP-NS-1762 | Resuscitation Devices |
| PP-OR-2217 | Laryngeal Masks |
| PP-FA-2138 | Medical Gas Pipeline Equipment |
| BT-OR-019 | Disposable Anesthesia |

Full Face Mask V

With Standard Headgear

Standard Elbow, Non-Vented

| Size | Item# |
|--------|---------------|
| Small | CM041S |
| Medium | CM041M |
| Large | CM041L |

Single Limb Elbow, Non-Vented, AAV

| Size | Item# |
|--------|-----------------|
| Small | CM041SEE |
| Medium | CM041MEE |
| Large | CM041LEE |

Single Limb Elbow, Vented, AAV

| Size | Item# |
|--------|------------------|
| Small | CM041SEEV |
| Medium | CM041MEEV |
| Large | CM041LEEV |

novaplus+

Standard Elbow, Non-Vented

| Size | Item# |
|--------|----------------|
| Small | VCM041S |
| Medium | VCM041M |
| Large | VCM041L |

Single Limb Elbow, Non-Vented, AAV

| Size | Item# |
|--------|------------------|
| Small | VCM041SEE |
| Medium | VCM041MEE |
| Large | VCM041LEE |

Single Limb Elbow, Vented, AAV

| Size | Item# |
|--------|-------------------|
| Small | VCM041SEEV |
| Medium | VCM041MEEV |
| Large | VCM041LEEV |

Replacement Cushions

| Size | Item# |
|--------|--------------------|
| Small | CUCM005S-10 |
| Medium | CUCM005M-10 |
| Large | CUCM005L-10 |



- Unobtrusive design offers a clear line of sight
- 360° dual-swivel elbow port allows for free movement while connected to the tubing
- Quick-release clips make it easy to remove the mask without resetting the headgear
- Ultra-lightweight silicone cushion increases comfort while maintaining optimal seal

With Cap Style Headgear

Standard Elbow, Non-Vented

| Size | Item# |
|--------|----------------|
| Small | CM041SC |
| Medium | CM041MC |
| Large | CM041LC |

Single Limb Elbow, Non-Vented, AAV

| Size | Item# |
|--------|------------------|
| Small | CM041SEEC |
| Medium | CM041MEEC |
| Large | CM041LEEC |

Single Limb Elbow, Vented, AAV

| Size | Item# |
|--------|-------------------|
| Small | CM041SEEVC |
| Medium | CM041MEEVC |
| Large | CM041LEEVC |

Sunset Deluxe Nasal CPAP Masks V

Mask with Headgear and Replaceable Cushion

| Size | Item# |
|--------|---------------|
| Small | CM006S |
| Medium | CM006M |
| Large | CM006L |

HG003 Headgear - Fits Most
HG003XL Headgear - XL

CMSIZE01
Deluxe Sizing Guide

HCPCS#
MASK - A7034
HEADGEAR - A7035
CUSHION - A7032



Same features as the full face with 360° dual-swivel elbow port, quick release clips, and ultra-lightweight replaceable cushions.

Mask without Headgear

| Size | Item# |
|--------|-----------------|
| Small | CM006SNH |
| Medium | CM006MNH |
| Large | CM006LNH |

Replacement Cushions

| Size | Item# |
|--------|-----------------|
| Small | CUCM006S |
| Medium | CUCM006M |
| Large | CUCM006L |

Nasal Mask V

With Standard Headgear

| Size | Item# |
|--------|---------------|
| Small | CM008S |
| Medium | CM008M |
| Large | CM008L |

novaplus⁺

| Size | Item# |
|--------|----------------|
| Small | VCM008S |
| Medium | VCM008M |
| Large | VCM008L |



Standard Elbow, Non-Vented

| Size | Item# |
|--------|---------------------|
| Small | CM008SVNV-10 |
| Medium | CM008MVNV-10 |
| Large | CM008LVNV-10 |

- Headgear clips allow for quick removal of mask — no further adjustments required after initial fitting
- One-piece mask and cushion design is durable and easy

Total Face Mask V

Standard Elbow

| Size | Item# |
|--------|---------------|
| Small | CM040S |
| Medium | CM040M |
| Large | CM040L |

Single Limb Elbow, Non-Vented, AAV

| Size | Item# |
|--------|-----------------|
| Small | CM040SEE |
| Medium | CM040MEE |
| Large | CM040LEE |



Sunset Deluxe Nasal Pillow CPAP Mask V

Mask with Headgear and Small, Medium, and Large Pillows

Item# **CM036**

Headgear Only **HG036**

HCPCS#
MASK - A7034
HEADGEAR - A7035
PILLOWS - A7033

Replacement Pillows

| Size | Item# |
|--------|----------------|
| Small | CM036SP |
| Medium | CM036MP |
| Large | CM036LP |



- Easy to fit, assemble, and maintain
- Three different pillow sizes to fit more people more easily
- 360° rotational elbow with flexible silicone tube
- Quiet vent design

Mask without Headgear **CM036NH**

Sunset Clearsight Deluxe Nasal Mask V

Mask with Headgear and Replaceable Cushion

| Size | Item# |
|--------|---------------|
| Small | CM110S |
| Medium | CM110M |
| Large | CM110L |

Replacement Cushions

| Size | Item# |
|--------|-----------------|
| Small | CUCM110S |
| Medium | CUCM110M |
| Large | CUCM110L |

HCPCS#
MASK - A7034
HEADGEAR - A7035



Clearsight design provides unobstructed view

Sol Full Face CPAP Mask

Mask with Headgear and Replaceable Cushion

10/case

| Size | Item# |
|--------|---------------|
| Small | CM205S |
| Medium | CM205M |
| Large | CM205L |

Replacement Cushions

| Size | Item# |
|--------|--------------------|
| Small | CUCM205S-10 |
| Medium | CUCM205M-10 |
| Large | CUCM205L-10 |

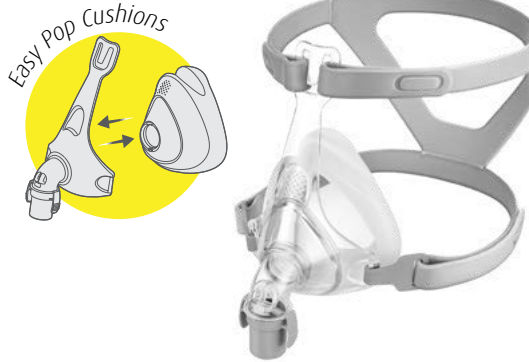

A premium mask without the premium price

Ray Pediatric Masks Comparable to Nonny masks

Mask with Headgear, Tube, and Replaceable Cushion

| Size | Item# |
|-------------|----------------|
| Small | CM061S |
| Medium | CM061M |
| Large | CM061L |
| Extra Large | CM061XL |



Replacement Cushions

| Size | Item# |
|-------------|------------------|
| Small | CUCM061S |
| Medium | CUCM061M |
| Large | CUCM061L |
| Extra Large | CUCM061XL |

Headgear Only

| Size | Item# |
|-------|---------------|
| Small | HG061S |
| Large | HG061L |



SCAN CODE to see Ray Full Face Mask on YouTube

Nasal Mask with Headgear, Tube, and Replaceable Cushions

| Comes with | Item# |
|---------------|-------------------|
| S&M Cushions | CM060-KITS |
| L&XL Cushions | CM060-KITL |



Replacement Cushions

| Size | Item# |
|-------------|------------------|
| Small | CUCM060S |
| Medium | CUCM060M |
| Large | CUCM060L |
| Extra Large | CUCM060XL |

Headgear Only

| Size | Item# |
|-------|---------------|
| Small | HG060S |
| Large | HG060L |



SCAN CODE to see Ray Nasal Mask on YouTube

Non-Vented Mask with Headgear, Tube, and Replaceable Cushion

| Size | Item# |
|-------------|-------------------|
| Large | CM061L-NV |
| Extra Large | CM061XL-NV |

Large and Extra Large sizes help fill a critical pediatric sizing gap, with more potential to avoid intubation.

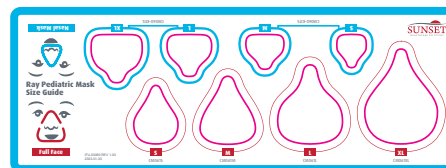
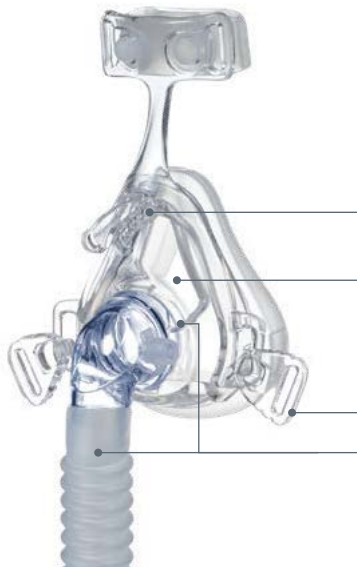

Available Size Guide

FinTek allows more adjustability to conform the mask to the face

One-piece molded silicone mask is small, light and comfortable

Headgear with 6-point velcro provides maximum comfort and versatility

Quick release clips

Dual 360 degree swivel elbow

- New non-vented configuration supports use in closed-circuit ventilation systems, including ICU settings
- Designed specifically for pediatric patients, reducing reliance on ill-fitting small adult masks
- Compatible with dual-limb circuits and adaptable to single-limb systems with an exhalation valve
- May support improved therapy delivery through better fit and system flexibility
- SKU reduction by reducing the need for multiple mask types per patient

Sleepnet Innova V

Nasal Mask with Headgear

Vented

| Size | Item# |
|--------------|----------------|
| Small/Medium | CM50180 |
| Medium/Large | CM50181 |

Non-Vented

| Size | Item# |
|--------------|----------------|
| Small/Medium | CM50594 |
| Medium/Large | CM50595 |

novaplus⁺

| Size | Item# |
|--------------|-----------------|
| Small/Medium | VCM034SM |
| Medium/Large | VCM034ML |

novaplus⁺

| Size | Item# |
|--------------|------------------|
| Small/Medium | VCM034NVM |
| Medium/Large | VCM034NVM |

Innova® CPAP masks feature patented AIR®gel with Advanced Cushion Technology and Active Headgear Connector™. Together, they provide an optimal fit, maximum comfort, and freedom.

- The Touchless Spacebar's unique design eliminates any contact with the patient's forehead
- The quick-release headgear is lightweight, breathable, and slides off easily with one hand
- Made in the USA



Sleepnet Ascend Mask Kit

Full Face System

Item# **CM037F**

Each

Vented

Mask Only

| Size | Item# |
|--------|--|
| Small | CM037S V |
| Medium | CM037M V |
| Large | CM037L V |

Replacement Cushions

| Size | Item# |
|--------|---|
| Small | CM037CS V |
| Medium | CM037CM V |
| Large | CM037CL V |



Nasal System

Item# **CM037N**

Each

Vented

Mask Only

| Size | Item# |
|--------|---|
| Small | CM037NS V |
| Medium | CM037NM V |
| Large | CM037NL V |

Replacement Cushions

| Size | Item# |
|--------|-----------------|
| Small | CM037NCS |
| Medium | CM037NCM |
| Large | CM037NCL |



Sleepnet Phantom®2 and iQ®2 V

Phantom®2

Item# **CM050**

Replacement Cushion **CUCM050**

Sleepnet's patented AIR®gel® technology provides maximum comfort while minimizing skin irritation and pressure points on the nasal bridge. Unlike many other gel masks, the unique qualities of AIR®gel® allow the mask to seal with minimal tension. By design AIR®gel® is twice as soft as competing gel products.



Replacement Frame/Tubing Assembly **CM051**

iQ®2

Item# **CM049**

Replacement Cushion **CUCM049**

- Sleepnet has the only mask that you can shape to each individual face. Flex, Fit, Forget!
- Cushions may be removed and replaced without purchasing a new mask.



Ask us about our 30-day mask guarantee

- Magnetic Clips — Easy on and off!
- 360° Swivel — Less tube drag for active sleepers.
- One size cushion — Larger fitting range.

Veraseal 2 Disposable Gel Mask with Headgear V



**Standard Elbow,
Non-Vented**



| Size | Item# |
|-------------|----------------|
| Small | CM50933 |
| Medium | CM50934 |
| Large | CM50935 |
| Extra Large | CM50936 |



| Size | Item# |
|-------------|-----------------|
| Small | VCM053S |
| Medium | VCM053M |
| Large | VCM053L |
| Extra Large | VCM053XL |



**Single Limb Elbow,
Non-Vented, AAV**



| Size | Item# |
|-------------|----------------|
| Small | CM50937 |
| Medium | CM50938 |
| Large | CM50939 |
| Extra Large | CM50940 |



| Size | Item# |
|-------------|-----------------|
| Small | VCM054S |
| Medium | VCM054M |
| Large | VCM054L |
| Extra Large | VCM054XL |



**Single Limb Elbow,
Vented, AAV**



| Size | Item# |
|-------------|----------------|
| Small | CM50827 |
| Medium | CM50828 |
| Large | CM50829 |
| Extra Large | CM50830 |



| Size | Item# |
|-------------|-----------------|
| Small | VCM052S |
| Medium | VCM052M |
| Large | VCM052L |
| Extra Large | VCM052XL |

- The Veraseal® 2 disposable full face mask brings AIR°gel® Technology to the acute care environment for a giant step forward in patient comfort. Three color coded elbow designs make choosing the right mask for CPAP, single, or dual limb circuit NIV systems simple. The Veraseal® 2 fits quickly and easily while enhancing patient comfort. Both vented (with leak ports) and non-vented (without leak ports) versions are available for CPAP, Bilevel, and ventilator therapy.
- The AIR°gel® cushion provides the utmost in gentle cushioning to protect from pressure points and irritation. AIR°gel® promotes advanced skin protection, superior performance, and unbeatable comfort, all in a lightweight mask.
- The active headgear connector moves as the patient moves for a reliable seal.
- Breathable headgear lets patients enjoy soft, lightweight stability they can count on for a comfortable fit.

MiniMe 2 Pediatric Nasal Mask V



Vented

| Size | Item# |
|-------------|----------------|
| Extra Small | CM60216 |
| Small | CM60217 |
| Medium | CM60218 |
| Large | CM60221 |

Non-Vented

| Size | Item# |
|-------------|----------------|
| Extra Small | CM60256 |
| Small | CM60257 |
| Medium | CM60258 |
| Large | CM60261 |



Vented

| Size | Item# |
|-------------|-----------------|
| Extra Small | VCM055XS |
| Small | VCM055S |
| Medium | VCM055M |
| Large | VCM055L |

Non-Vented

| Size | Item# |
|-------------|-----------------|
| Extra Small | VCM056XS |
| Small | VCM056S |
| Medium | VCM056M |
| Large | VCM056L |



- Maximum comfort, minimum weight. Patented AIR°gel makes MiniMe masks some of the most gentle fitting masks on the market.
- The shapeable shell mask can be easily molded to fit individual needs.
- 100% designed and manufactured in the USA.

Pediatric SleepWeaver® CPAP Mask V

Item#
CM101325



The launch of the SleepWeaver Advance Pediatric Soft Cloth CPAP Mask marks the development of a revolutionary interface for CPAP use in pediatric patients. This new configuration extends the range of SleepWeaver products to include pediatric users with delicate facial features.

- Same proven cloth technology enhanced to accommodate children 2 through 7 years of age

MiniMe Pediatric Nasal Mask V



| Headgear Size | Item# | OEM# |
|---------------|---------------|---|
| Small | CM004S | 60213 |
| Medium | CM004M | 60214 P |
| Large | CM004L | 60215 |

HCPCS# A7034

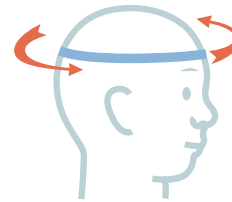

| MASK SIZE | HEAD CIRCUMFERENCE |
|-----------|--------------------|
| SMALL | 14-16in |
| MEDIUM | 17-18in |
| LARGE | 19-21in |

Measure around head above eyebrows for head circumference

SleepWeaver® Advance Nasal Mask V

Item#
CM017B

Mask with Adjustable Headgear

- Easy to store and pack for travel

OEM# 100274
HCPCS# A7034



NIV Tubing

19mm with 22mm cuffs
10/case*

Item#

TUB0018 18in

TUB02 2ft

TUB004 4ft

TUB06 6ft *Individually Packed V

SUH0610 6ft V

TUB08 8ft V P

TUB010 10ft V P



- Sunset's most popular item
- ISO standard 22mm cuffs
- Smooth interior and a corrugated exterior for excellent flexibility and unrestricted interior flow characteristics
- Injection molded cuffs to reduce tearing
- Low memory to avoid kinks
- BPA-free and latex-free

Slim CPAP Tube V P

Item#

TUB006SS

6ft x 15mm with
22mm cuffs

HCPCS# A7037



Highly durable

Strain relief cuff decreases separation and tearing

Virtually no memory

Designed to be the most flexible tube available

Minimal weight

One of the lightest tubes on the market at 2.6 ounces

Great value

Affordable and sustainable

Heated Tube for Respironics P V Vizient Contract MS1087

Item#

TUB06HPR

Heated Tube for Philips Respironics Dreamstation Series and System One

OEM# HT15

HCPCS# A4604

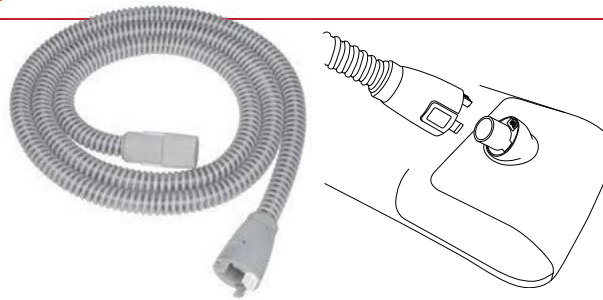

- 510(k)
- UL Recognized
- Strain relief cuffs
- Auto safety shut-off

Standard Elbow, Non-Vented V

Item# **CAP009**
10/case



Single Limb Elbow, Non-Vented, AAV V

Item# **CAP008**
10/case



Swivel Connector Silencer

Item#

VEN002 Each P

VEN002-10 10/pack V Contract MS1087



Single Use Exhalation Port V

Item# **VEN003**
10/pack



Standard 4-Point Headgear V

Item#
HG003S Small
HG003M Medium
HG003L Large



Cap Style Headgear V

Item# **HG002**



Universal Neoprene Chinstrap V

Item#
CS001
 Universal Chinstrap
 HCPCS# A7036

- Latex-free
- One size fits most
- Attaches to itself at the top of the head
- Can be used with any nasal mask or pillows



Deluxe Chinstrap V

| Size | Item# |
|------|---------------|
| 26in | CS004S |
| 28in | CS004L |

Compare to
 Respronics Deluxe
 OEM# 302425
 HCPCS# A7036

- Latex-free
- Attaches to itself at the top of the head, two smaller support straps keep the system in place
- Extra-wide strap distributes pressure to add comfort



Comfort Chinstrap V

Item# **CS005**
 Compare to
 ResMed Sullivan
 OEM# 16015
 HCPCS# A7036

- Latex-free
- One size fits most
- Easy to use —attaches to itself at the top of the head
- Soft cloth chin cup adds comfort



Premium Chinstrap V

Item# **CS006**
 Compare to
 Respronics Premium
 OEM# 1012911
 HCPCS# A7036

- One size fits most
- Attaches to itself at the top of the head to keep the chin lifted. Smaller support strap attaches to a split section of the chinstrap and wraps around the head for added stability.



Ruby Style Adjustable Chinstrap



| Size | Item# |
|-------------|--------------------|
| Regular | CS007-ADJ |
| Extra Large | CS007-ADJXL |

HCPCS# A7036

- Latex-free
- Fully adjustable
- Super soft materials for extra comfort



Ruby Style Chinstrap

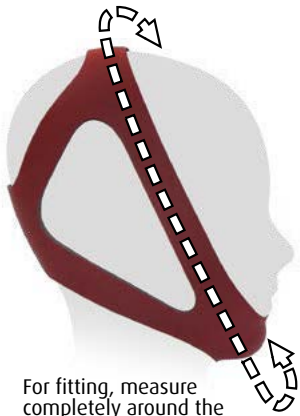

For fitting, measure completely around the head, as indicated by the dashed line above.

| Size | Item# |
|-------------|---------------|
| 21.5-22.5in | CS007S |
| 22-23in | CS007M |
| 23-24in | CS007L |

Compare to Puresom Ruby
OEM# TMS-09 · HCPCS# A7036

- Latex-free
- One piece stretches to slide over the top of the head — no need to Velcro
- Can be used with any nasal mask or pillows

Halo Style Chinstrap V

Item# **CS025**
Compare to BreatheWear
Halo Chinstrap
OEM# H3407
HCPCS# A7036



Microflow Microdial Flowmeter P

2024 Innovation Celebration Winner



DISS Inlet • Barbed Outlet

| Item# | Inlet Pressure Range | Flow Range* |
|-------------------|----------------------|-------------|
| RES8160048 | 345 - 500 kPa | A |
| RES8160050 | 350 - 550 kPa | E |



DISS Inlet • DISS Outlet

| Item# | Inlet Pressure Range | Flow Range* |
|-------------------|----------------------|-------------|
| RES8160049 | 345 - 500 kPa | A |
| RES8160051 | 250 - 450 kPa | E |

*Volumetric flow rates in standard liters per minute

| Dial Position | Off | 1 | 2 | 3 | 4 | 5 | 6 | 7 | 8 | 9 | 10 | 11 |
|----------------|-----|------|------|------|------|------|------|------|------|------|-----|----|
| Range A | 0 | 0.02 | 0.03 | 0.05 | 0.08 | 0.12 | 0.2 | 0.3 | 0.5 | 0.75 | 1 | 3 |
| Range E | 0 | 0.01 | 0.02 | 0.03 | 0.04 | 0.05 | 0.06 | 0.07 | 0.08 | 0.09 | 0.1 | 1 |

Assured, repeatable accuracy to enable safe, effective weaning.

What is Microflow used for?

Microflow is primarily used to supply supplementary oxygen to infants with bronchopulmonary dysplasia (BPD).

BPD is common in very low birth weight and pre-term infants that have needed mechanical ventilation or have been treated with high oxygen concentrations due to respiratory distress syndrome (RDS)/chronic lung disease (CLD).

The risk of RDS/CLD is inversely related to birth weight and gestational age.

Infants may need very low supplementary oxygen for many months to compensate for underdeveloped lungs.



Microflow benefits

- Enables baby to receive oxygen therapy at home, putting families together sooner and increasing parent satisfaction
- Less time in hospital, lower cost of care
- Accurate, repeatable steps
- Micro step changes in flow
- Enables low flow rates to achieve target saturation
- Enables oxygen flow to be weaned

Non-Heated Breathing Circuits

For use with Respironics Trilogy
22mm cuffs
30/case

| Item# | OEM# | Mode | Water Trap | Size | Tube Diameter |
|----------------|-------------------|---------|------------|-----------|---------------|
| VC1001 | 1073223 & 1073232 | Active | No | Adult | 22mm |
| VC1001P | 1073220 & 1073229 | Active | Yes | Pediatric | 15mm |
| VC1004 | 1069443 & 1069444 | Passive | Yes | Adult | 22mm |
| VC1004P | 1073224 & 1073233 | Passive | Yes | Pediatric | 15mm |

Item#
VC1001 V P
Active Adult
OEM#
1073223
1073232

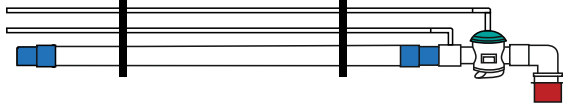

Item#
VC1001P
Active Pediatric
OEM#
1073220
1073229

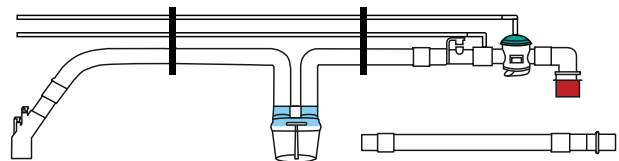

To use active circuits with Respironics Trilogy, simply cut ends off pressure and exhalation lines.

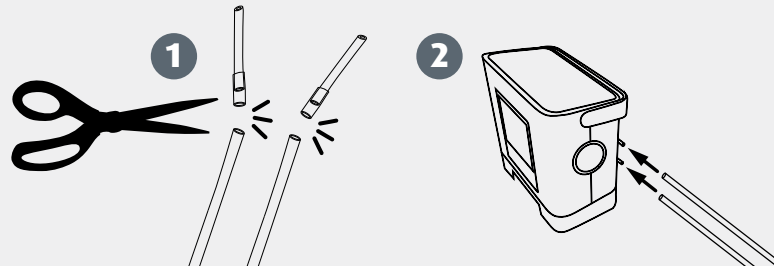

Item#
VC1004 V P
Passive Adult
OEM#
1069443
1069444

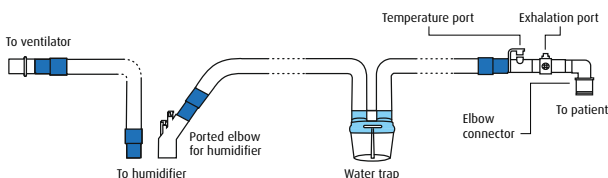

Item#
VC1004P V P
Passive Pediatric
OEM#
1073224
1073233

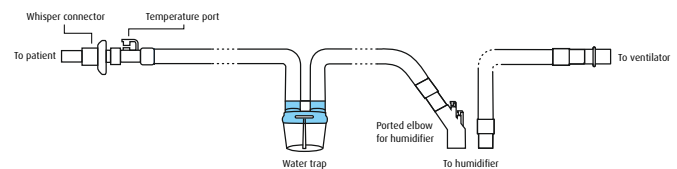

Adult Passive Heated Circuit with Exhalation Port **V** **P**

30/case

For use with Philips
Respironics Trilogy

Item#
VC1003

VC1003P
Pediatric Size

Comparable to OEM# 1076046,
1073227, 1073235



Includes:

- 1 VC1114 Passive Heated Breathing Circuit
- 1 VEN002 Swivel Exhalation Port

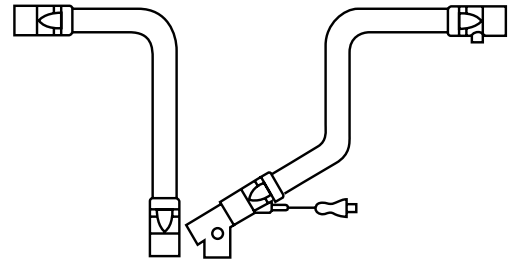

Passive Circuit w/Exhalation Port and Bacterial/Viral Filter **V** **P**

With 22mm cuffs

Item#
VC1005
Each

OEM# 1147378, 1132340, 7615



Adult Passive Circuit with Bacteria Filter **V**

Comparable to Breas 007936

Item#
VC1006
Each



Adult Passive Circuit with Bacteria Filter and T-Adapter **V**

Comparable to Breas 007615

Item#
VC1007
Each



Passive Non-Heated Breathing Circuits V P

Exhalation Port

| Exhalation Port | Item# | OEM# |
|-----------------|---------------|-------------------|
| Swivel | VC1000 | 1073228 & 1073236 |
| Fixed | VC1100 | 1069467 & 1069468 |

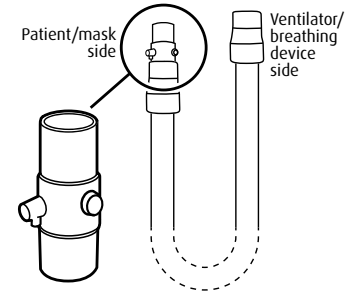

Passive Heated Breathing Circuit V P

Item#
VC1114
For use with
MR850 Humidifier
10/case
VC1114P
Pediatric

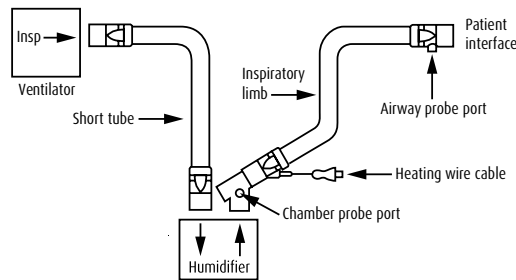

Non-Heated Dual Limb Breathing Circuits V P

30/case

| Item# | Size | Humidifier Limb | Water Trap |
|----------------|-----------|-----------------|------------|
| VC2001P | Pediatric | No | No |
| VC2001 | Adult | No | No |
| VC2002P | Pediatric | Yes | No |
| VC2002 | Adult | Yes | No |
| VC2003 | Adult | Yes | Yes |



Adult NIV Patient Circuit **V** **P**

Item# **VC1160**
Compatible with V60, No Filters
10/case
Comparable to
OEM# 1069210

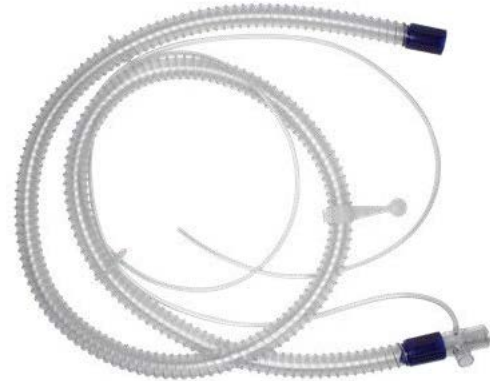
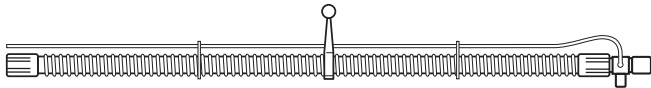

Adult NIV Single Limb Patient Circuit with Main Flow Filter **V** **P**

Item# **VC1161**
Includes 1 BF2200 22mm Bacteria Disk Filter
10/case



Adult NIV Single Limb Patient Circuit with Main Flow Filter and Exhalation Port Filter **V** **P**

Item# **VC1162**
Includes 2 BF2200 22mm Bacteria Disk Filters
10/case

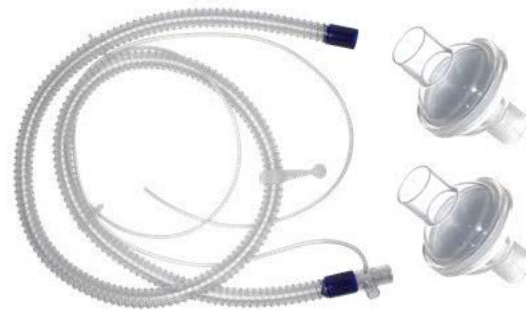

Lynx Venturi Oxygen Delivery **V** **P**

Low Concentration

Item# **RES2400**

Each

Adapter Only **RES240LC**

- Design replaces multiple venturi adapters
- Connects to oxygen tubing and regulates flow
- Provides precision FiO₂ delivery from 24-60% with less than 2% variance during mild, moderate, and severe respiratory distress
- Excellent CO₂ washout

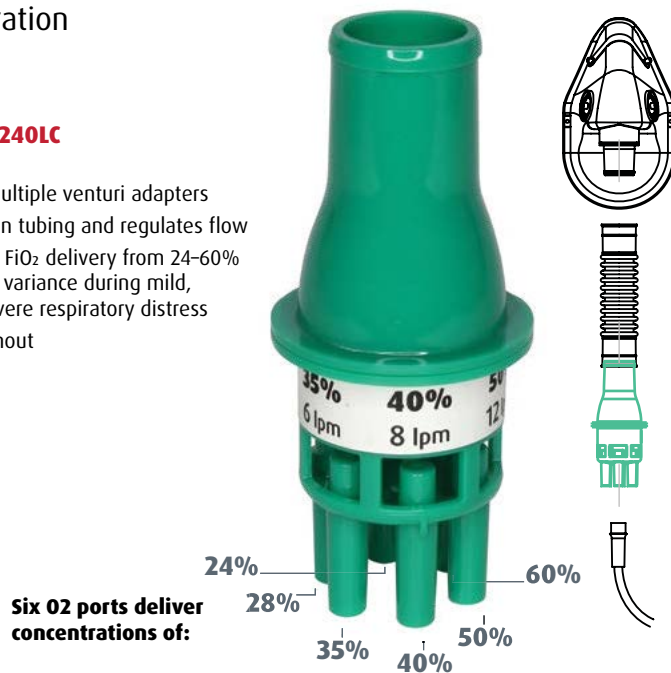

Unprecedented simplicity

No training required. Intuitive design makes it easy for nurses to operate without assistance, freeing up RTs to work where most needed.

Do no harm

Quicker de-escalation of O₂ levels and prevention of excessive CO₂ in the patient.

Reduction in waste

Remains with patient throughout EMS and hospital journey, replacing multiple adapters which may get lost or contaminated during transition.

Unmatched precision

Provides specific levels of oxygen with less than 2% variance. Comparable products vary by as much as 30%.

High Concentration

Item# **RES2401**

Each

Adapter Only **RES241HC**

- Allows rapid de-escalation of FiO₂ in the EMS ambulance or ED to prevent CO₂ buildup.
- Replaces bulkier high concentration venturis and non-rebreather bag systems
- Accurate assessment of the severity of hypoxemia (PaO₂/FiO₂) allows early intervention and better outcomes
- Excellent CO₂ washout

Single flow (flush) with an adjustable window shutter delivers oxygen concentrations of 65% • 80% • 100%

Capabilities could include replacing non-rebreathers and/or partial rebreather products

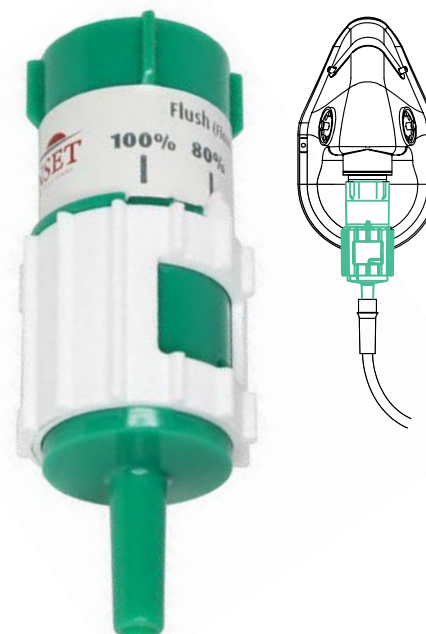

Simple O₂ Mask V P

With 7ft Safety Tubing
 Elongated

Item# **RES2100**
 Adult Size
 50/case



- 5-12 LPM
- Medium concentration
- Clear, soft vinyl for patient comfort
- Adjustable nose clip for secure seal

Medium Concentration Oxygen Mask

50/case

| Item# | Size | Tubing Length | Connector | V | P |
|------------------|-----------|---------------|-----------|------------------------------------|-------------------------------------|
| RES2100NT | Adult | None | Standard | V | P |
| RES2100P | Pediatric | 7 ft | Standard | V | P |
| RES2100U | Adult | 7 ft | Universal | V | P |
| RES2203I | Infant | None | Standard | V | |
| RES2203P | Pediatric | None | Standard | V | P |
| RES2203A | Adult | None | Standard | V | P |
| RES2203A7 | Adult | 7 ft | Standard | V | P |
| RES2203I7 | Infant | 7 ft | Standard | V | P |
| RES2203P7 | Pediatric | 7 ft | Standard | V | P |

- 5-12 LPM
- Clear, soft vinyl for patient comfort
- Adjustable nose clip for secure seal



High Concentration Oxygen Mask

50/case

| Item# | Size | Tubing Length | V | P |
|------------------|-----------|---------------|------------------------------------|-------------------------------------|
| RES2202A | Adult | None | V | P |
| RES2202A7 | Adult | 7 ft | V | |
| RES2202I | Infant | None | V | P |
| RES2202I7 | Infant | 7 ft | V | P |
| RES2202P | Pediatric | None | V | |
| RES2202P7 | Pediatric | 7 ft | V | |



- 10+ LPM
- Low-resistance check valves prevent rebreathing and allow exhaled gas to escape
- Clear, soft vinyl for patient comfort
- Adjustable nose clip for secure seal

Non-Rebreather Oxygen Mask

50/case

| Item# | Size | Tubing Length | Connector | Safety Vent | |
|------------|-----------|---------------|-----------|-------------|-----|
| RES2102 | Adult | 7 ft | Standard | No | V P |
| RES2102I | Infant | 7 ft | Standard | No | V P |
| RES2102IM | Infant | 7 ft | Standard | No | V |
| RES2102P | Pediatric | 7 ft | Standard | No | V P |
| RES2102PS | Pediatric | 7 ft | Standard | Yes | V P |
| RES2102PSM | Pediatric | None | Standard | Yes | V P |
| RES2102PSU | Pediatric | 7ft | Universal | Yes | V P |
| RES2102PU | Pediatric | 7 ft | Universal | No | V P |
| RES2102S | Adult | 7 ft | Standard | Yes | V P |
| RES2102SM | Adult | None | Standard | Yes | V P |
| RES2102U | Adult | 7 ft | Universal | No | V P |

- 10+ LPM
- Low-resistance check valves prevent rebreathing and allow exhaled gas to escape



Adult Air Entrainment Mask

With Flex Tube

50/case

| Item# | Size | Kit | Tubing Length | Connector | |
|------------|-----------|-----------|---------------|-----------|-----|
| RES2400A | Adult | Mask Only | 7 ft | Standard | V P |
| RES2400AK | Adult | Yes | 7 ft | Standard | V P |
| RES2400AKU | Adult | Yes | 7 ft | Universal | V P |
| RES2400AU | Adult | Mask Only | 7 ft | Universal | V P |
| RES2400P | Pediatric | Mask Only | 7 ft | Standard | V |
| RES2400PK | Pediatric | Yes | 7 ft | Standard | V P |
| RES2400PKU | Pediatric | Yes | 7 ft | Universal | V |
| RES2400PU | Pediatric | Mask Only | 7 ft | Universal | V P |



Humidoflo High Flow Nasal Cannula V P

10/case

- Tube Side Quick Switch connects tube to either side of the patient
- Kink-free prongs and flexible, low-noise tube
- Compatible with any ventilator with a standard 22mm ISO connector, including Respirationics V60
- Suitable alternative to Philips AC611
- Can be used with F&P 850 and 950 with HFN001-FPA adapter
- Comparable to F&P OptiFlow cannula (OPT942, OPT944, OPT946)

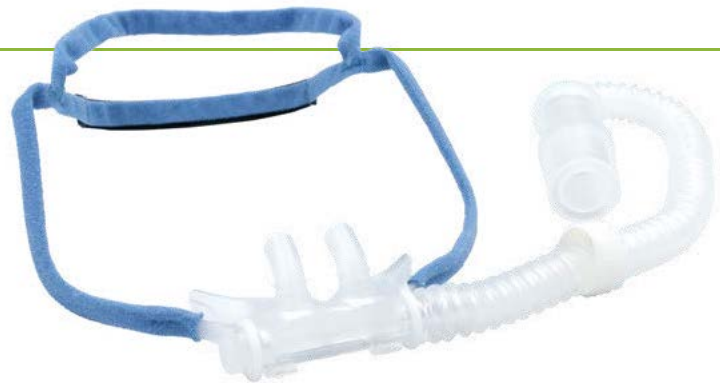

| Size | Item# |
|--------|-----------------|
| Small | HFN001AS |
| Medium | HFN001AM |
| Large | HFN001AL |

| With F&P Adapter | |
|------------------|------------------|
| Size | Item# |
| Small | HFN001ASA |
| Medium | HFN001AMA |
| Large | HFN001ALA |

Adult Oxygen Cannula

| Item# | Tubing Length | Connector | Qty | |
|------------------|---------------|-----------|-----|-------------------------------|
| RES1100 | None | Standard | 50 | V P |
| RES1100N | None | Standard | 50 | V |
| RES1104 | 4 ft | Standard | 50 | V P |
| RES1107 | 7 ft | Standard | 50 | V P |
| RES1107N | 7 ft | Standard | 50 | V P |
| RES1107NU | 7 ft | Universal | 50 | V |
| RES1107U | 7 ft | Universal | 50 | V P |
| RES1110 | 10 ft | Standard | 50 | V P |
| RES1114N | 14 ft | Standard | 50 | V P |
| RES1114U | 14 ft | Universal | 50 | V P |
| RES1115 | 15 ft | Standard | 50 | V P |
| RES1115U | 15 ft | Universal | 50 | V P |
| RES1125 | 25 ft | Standard | 25 | V P |
| RES1135 | 35 ft | Standard | 20 | V |
| RES1150Z | 50 ft | Standard | 20 | V |
| RES1150U | 50 ft | Universal | 20 | V P |



- 1-6 LPM
- 6-channel supply tubing for safety

Soft Cannula

| Item# | Tubing Length | Connector | Qty | |
|------------------|---------------|-----------|-----|-------------------------------|
| RES1100S | None | Standard | 50 | V P |
| RES1107S | 7 ft | Standard | 50 | V P |
| RES1107SU | 7 ft | Universal | 50 | V P |
| RES1114S | 14 ft | Standard | 50 | V P |
| RES1114SU | 14 ft | Universal | 50 | V P |
| RES1115S | 15 ft | Standard | 50 | V P |
| RES1125S | 25 ft | Standard | 25 | V P |
| RES1125SU | 25 ft | Universal | 25 | V |



- 1-6 LPM
- 6-channel supply tubing for safety

Pediatric, Infant, and Neonate Cannula

50/case

| Item# | Size | Tubing Length | Connector | Touch | Ear Cushions |
|-------------|-----------|---------------|-----------|----------|--------------|
| RES1100P | Pediatric | None | Standard | Standard | No |
| RES1107I | Infant | 7 ft | Standard | Standard | No |
| RES1107NE | Neonate | 7 ft | Standard | Standard | No |
| RES1107P | Pediatric | 7 ft | Standard | Standard | No |
| RES1107PEC | Pediatric | 7 ft | Standard | Standard | Yes |
| RES1107PECU | Pediatric | 7 ft | Universal | Standard | Yes |
| RES1107SI | Infant | 7 ft | Standard | Soft | No |
| RES1107SIU | Infant | 7 ft | Universal | Soft | No |
| RES1107SNE | Neonate | 7 ft | Standard | Soft | No |
| RES1107SP | Pediatric | 7 ft | Standard | Soft | No |
| RES1107SPU | Pediatric | 7 ft | Universal | Soft | No |
| RES1114P | Pediatric | 14 ft | Standard | Standard | No |
| RES1114PU | Pediatric | 14 ft | Universal | Standard | No |
| RES1114SP | Pediatric | 14 ft | Standard | Soft | No |
| RES1114SPU | Pediatric | 14 ft | Universal | Soft | No |

- 1-6 LPM
- 6-channel supply tubing for safety

Adult Cannula with Ear Cushions

| Item# | Tubing Length | Connector | Qty |
|------------|---------------|-----------|-----|
| RES1100EC | None | Standard | 50 |
| RES1104EC | 4 ft | Standard | 50 |
| RES1107EC | 7 ft | Standard | 50 |
| RES1107ECU | 7 ft | Universal | 50 |
| RES1114EC | 14 ft | Standard | 50 |
| RES1115EC | 15 ft | Standard | 50 |
| RES1125EC | 25 ft | Standard | 25 |

Flared Cannula V

| Item# | Tubing Length | Connector | Qty |
|-----------|---------------|-----------|-----|
| RES1100F | None | Standard | 50 |
| RES1107F | 7 ft | Standard | 50 |
| RES1107FU | 7 ft | Universal | 50 |
| RES1114F | 14 ft | Standard | 50 |
| RES1114FU | 14 ft | Universal | 50 |
| RES1125F | 25 ft | Standard | 25 |
| RES1150F | 50 ft | Standard | 20 |

- Now softer
- 6-15 LPM
- Maintains saturation for high-flow patients without a mask
- 6-channel supply tubing for safety

High Flow Soft Cannula V

25/case

| Item# | Tubing Length |
|------------|---------------|
| RES1104SHF | 4ft |
| RES1107SHF | 7ft |
| RES1115SHF | 15ft |
| RES1125SHF | 25ft |



7 ft Cannula With CO₂ Sampling Line V

50/case

| Item# | Size | Connector | Luer | Filter |
|------------------|-----------|-----------|--------|--------|
| RES8007 | Adult | Standard | Male | No |
| RES8007F | Adult | Standard | Male | Yes |
| RES8007I | Infant | Standard | Male | No |
| RES8007IF | Infant | Standard | Male | Yes |
| RES8007IU | Infant | Universal | Male | No |
| RES8007P | Pediatric | Standard | Male | No |
| RES8007PF | Pediatric | Standard | Male | Yes |
| RES8007PU | Pediatric | Universal | Male | No |
| RES8007U | Adult | Universal | Male | No |
| RES8107 | Adult | Standard | Female | No |
| RES8107F | Adult | Standard | Female | Yes |
| RES8107I | Infant | Standard | Female | No |
| RES8107IF | Infant | Standard | Female | Yes |
| RES8107P | Pediatric | Standard | Female | No |
| RES8107PF | Pediatric | Standard | Female | Yes |

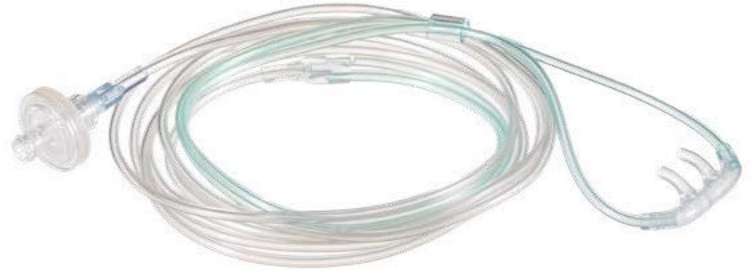

Secure Cannula Stickers V P

Item# **RES080**
 25 pairs/case

- Holds cannula in place
- Easy to use
- Flexible, sheer fabric
- Designed to let skin breathe and peel off without leaving residue
- Latex-free
- Individually wrapped pairs

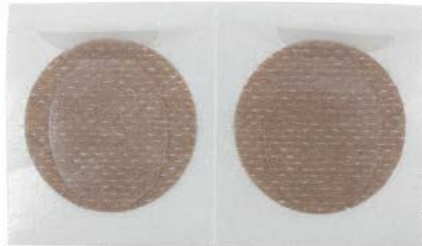

Ear Cushions for Cannula V P

Item# **RES020**
 Cushions Only
 50 Pairs/case

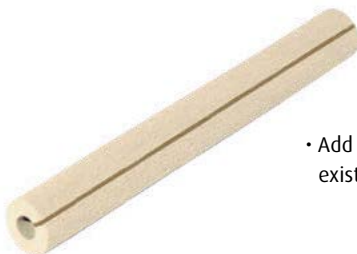

- Add cushions to existing cannula

Oxygen Supply Tubing

| Item# | Length | Connector | Bore | Color | Qty | |
|------------------|--------|-----------|----------|-------|-----|-----|
| RES3007 | 7 ft | Standard | Standard | None | 50 | V P |
| RES3007G | 7 ft | Standard | Standard | Green | 50 | V P |
| RES3007SB | 7 ft | Standard | Smooth | Green | 50 | V |
| RES3007U | 7 ft | Universal | Standard | None | 50 | V P |
| RES3015 | 15 ft | Standard | Standard | None | 50 | V P |
| RES3015G | 15 ft | Standard | Standard | Green | 50 | V |
| RES3025 | 25 ft | Standard | Standard | None | 25 | V P |
| RES3025G | 25 ft | Standard | Standard | Green | 25 | V P |
| RES3025U | 25 ft | Universal | Standard | None | 25 | V P |
| RES3030 | 30 ft | Standard | Standard | None | 20 | V |
| RES3030G | 30 ft | Standard | Standard | Green | 20 | V |
| RES3040G | 40 ft | Standard | Standard | Green | 20 | V P |
| RES3050 | 50 ft | Standard | Standard | None | 20 | V |
| RES3050G | 50 ft | Standard | Standard | Green | 20 | V P |

- 6-channel
- PHT/DEHP-free



Universal Connector

CPAP Tubing V P

Item#

TUB008 8ft

TUB010 10ft

19mm with 22mm cuffs

HCPCS# A7037



- Compatible with nearly all CPAP, BiPAP and BiLevel systems for every manufacturer on the market
- Smooth interior and a corrugated exterior for excellent flexibility and unrestricted interior flow characteristics
- Injection molded cuffs to reduce tearing
- Low memory to avoid kinks
- BPA-free and latex-free

Firesafe Thermal Shut-Off Valve V

Item#
RES010-10
 Bidirectional
 10/case



- A thermal fuse designed to stop the flow of gas in the event that the downstream oxygen tubing is ignited
- Helps protect against oxygen tubing fires
- Helps keep patients safe no matter what method of oxygen delivery they use
- Offers a cost-effective solution to lower the risk of serious patient injury in an oxygen fire
- Smaller
- Laser etched
- Expiration date
- Human readable UDI
- Designed to last 5 years

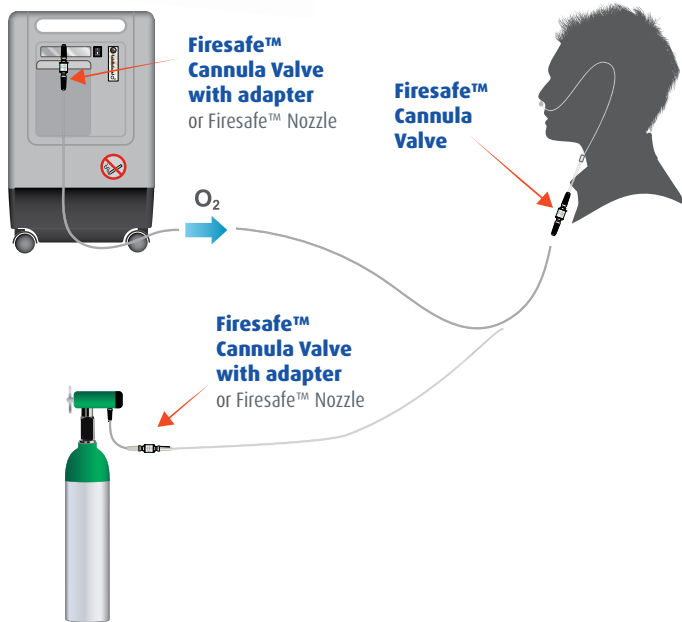

Home oxygen fires represent a much higher risk in the United States than the United Kingdom, where the fitting of thermal fuses for oxygen is mandatory.

Fatalities per 100,000 patients



FireSafe Nozzle V P

Item#
RES010FND
 10/pack



FireSafe Tubing Connector

Item#
RES010TC 100/case V
RES010TC-10 10/case



Christmas Tree Connector

Item# **RES001** V P
Green without Swivel
10/pack



RES001-30 P
30/pack

Item# **RES002** V P
Green with Swivel
10/pack



- Tapered and barbed nut and nipple assembly allows secure tubing connections
- For standard DISS threaded oxygen outlets
- Improved threading is easier to connect to regulators or flow meters

Oxygen Tubing Connector — Non-Swivel V P

Item# **RES012**
Fits 3/16in and 1/4in
ID Tubing
10/pack



- Barbed ends ensure secure, leak-free connections

Tubing Reducer Connector V P

Item# **RES011**
Fits 3/16in, 1/4in,
5/16in, 3/8in, and 7/16in
ID Tubing
10/pack



- Tapered on both ends to connect multiple sizes of tubing, works with suction, oxygen, and catheter tubing

Humidifier Tubing Adapter V P

Item# **RES016**
22mm ID x
22mm OD
with Lip
10/pack



Circuit Connectors V P

Item# **RES013**
22mm OD x
15mm ID/
22mm OD
10/pack



Item# **RES014**
22mm OD x
22mm OD
With Lip
10/pack



Oxygen Tubing Connector — Swivel

Item# **RES018** V P
Male/Male
10/pack
RES018-1 1/pack



RES018-25 P
25/pack

Oxygen Tubing Y-Connector V P

Item# **RES017**
Fits 3/16in and 1/4in ID Tubing
(All 3 sides are the same)
10/pack



- Connects two oxygen sources for higher flows

Connector with 6mm Oxygen Stem V P

Item# **RES058**
22mm with 6mm Stem
10/pack



Oxygen Bleed-In Adapter V P

Item# **RES019**
22mm with 6mm
Rotating Stem
10/pack
RES019-1 1/pack



Finger Pulse Oximeter **P**

Item# **RES5102**
Each



- Oversized 1.3" OLED display face
- Features large numeric font
- Five grades of brightness adjustment
- Displays SpO2, PR and PI parameters and pulse wave graph
- Offers buzzer, demo and visual alarm functions
- Easy to navigate menu sets alarm limits or switches buzzer on/off
- Includes lanyard and manual

Wrenches **V P**

Item# **RES031**
With Chain
10/pack
RES031-1 1/pack



Water Traps **V P**

Item# **RES037**
Push On End Caps
Each



- Keeps water out of cannula
- Connects between cannula and supply tubing
- Removable end caps allows drainage of accumulated water
- 9cc water capacity in horizontal position

Oxygen Liter Meter **V P**

Item# **RES034**
0-10 Liter/Minute
Each



- Oxygen pen
- Works with tanks and concentrators

Humidifier Connectors **V P**

Item# **HUM008**
L-Connector 12in
10/pk
HUM008-1 1/pack

HUM008L
L-Connector 21in
10/pk

HUM008S
Straight Connector 9in
10/pk

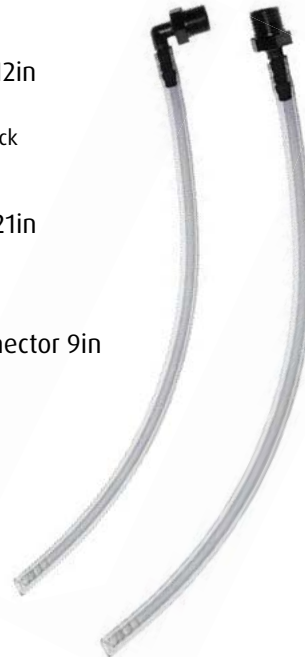

Covers for Concentrators **P**



Item# **EC251530C**
25x15x30"
1.5mil • Clear
250 bags/roll

SpO2 Sensors

NEW

Disposable SpO2 Sensor Neonatal/Adult

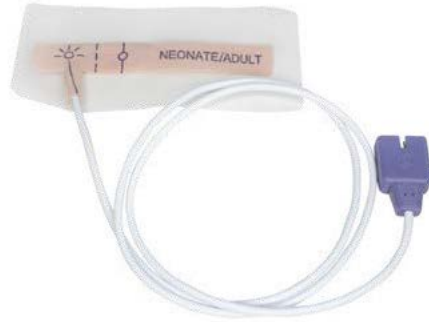
Item# **RES7100**Similar to Nellcor MAX-N
20/box

Neo-M-1.5 Disposable SpO2 Sensor Neonatal/Adult (<3 kg or >40 kg)

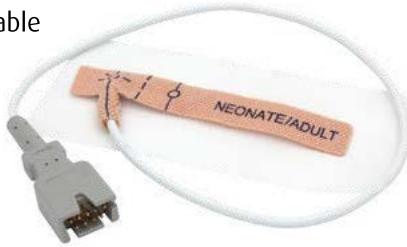
Item# **RES7200**1.5ft cord • Non-replaceable
20/box

Neo-M-3 Disposable SpO2 Sensor Neonatal/Adult (<3 kg or >40 kg)

Item# **RES7201**3ft cord • Non-replaceable
20/box

Coban Tape Roll

Item# **RES7202CT**Use for sensor life
extension or sensor
cord stability**Each roll 1" x 177"**

Infant-M-1.5 Disposable SpO2 Sensor Infant (3-20 kg)

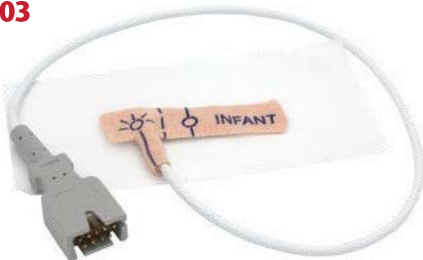
Item# **RES7203**1.5ft cord
20/box

Pediatric-M-1.5 Disposable SpO2 Sensor Pediatric (10-50 kg)

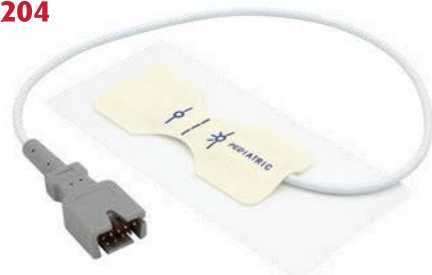
Item# **RES7204**1.5ft cord
20/box

Suction Machine Inline Filters V P



Item# **BF1412**
 Final Bacteria Filter •
 1/4in to 1/2in Stepped
 Barb on Both Sides
10/pack



Item# **BF1312**
 1/3in to 1/2in
1/pack



Item# **BF3812**
 3/8in to 1/2in
10/pack



Item# **BF516TS**
 5/16in Barbed with
 Threaded NPT
10/pack

Oxygen Filters



Item# **BF316** V P
 Final Bacteria Filter •
 3/16 Stepped Barb and
 1/4in Straight Barb on
 Both Sides
10/pack
BF316-1 1/pack



Item# **BF516** V P
 Final Bacteria Filter •
 1/4in Barbed
10/pack
 OEM# P0750X030



Item# **BF1438** P
 1/4in to 3/8in
10/pack

HEPA Filter for 3B Stratus V P

Item# **BF6020**
 HEPA Filter
Each
 OEM# STR1020



6in HEPA Capsule with Removable Sticker V P

Item# **BFH6S**
 Threaded
Each



Disposable Bubble Humidifier 500 ml P

Item#
RES050
 Up to 15 LPM • 6 psi • 500 ml
50/case
 HCPCS# E0560
 OEM# HUM001

- Multi-threaded lid ensures a secure fit, preventing leaks and service calls
- Audible back pressure alarm activates at 6 psi
- No aluminum fitting in stem eliminates aluminum shreds often found in lower quality models
- Soft plastic diffuser reduces clogging due to mineral build-up
- Translucent jar provides improved visibility of jar contents

- Humidifier bottle lid is colored green/yellow, making it easy to tell patients on the phone how to change the bottle
- Bottle fill line is very easy to see
- Finger grips at the top of the bottle make the lid easier to screw on/off for the patient



Extended Life Intake Bacteria Filter V P

Item#
OF1025D
Each

**Foam Cabinet Filter** V P

Item# **OF9001**
6³/₄" x 3³/₈" x 1/2"
10/pack
OEM# 2000489



For Invacare
Mobilaire and
HomeFill oxygen
concentrators

Mobilaire 3 and 5 Kit P

Item# **OF9001SP**
2 Foam Cabinet Filters
1 HEPA Filter 6in Capsule
1 Final Bacteria Filter
Each

**Invacare Platinum 5 and 10 Style Filter** V P

Item# **OF9002**
Foam Cabinet Filter
9" x 27/8" x 1/2"
10/pack
OEM#1107412

**3B Stratus 5 Style Filter** P

Item# **OF6030**
Foam Cabinet Filter
10/pack
OEM# STR1030

**Invacare Perfecto2 Style Filter** V P

Item# **OF9004**
Foam Cabinet Filter
6⁷/₈" x 3³/₄" x 1/2"
10/pack
OEM# 1143492

**Extended Life Bacteria Filter with Muffler** V P

Item# **OF6011**
22mm fittings
Each
Use if SolAiris was
manufactured
before Nov '03



For Drive/DeVilbiss
SolAiris and
525 Series oxygen
concentrators

Perfecto2 Kit P

Item# **OF9004SP**
2 Foam Cabinet Filters
1 HEPA Filter 6in Capsule
1 Final Bacteria Filter
Each

**DeVilbiss/Drive SolAiris III, 303 Series Style Filter** V P

Item# **OF5004**
Foam Cabinet Filter
3³/₄" x 3³/₄" x 1/2"
10/pack
OEM# 30302605

**EverFlo Kit** P

Item# **OF1003SP**
1 Intake Filter
1 Final Bacteria Filter
Each

**SolAiris V Kit** P

Item# **OF5005SP**
2 Foam Cabinet Filters
1 Extended Life Bacteria Filter
w/Muffler
1 Final Bacteria Filter
Each



Inline Bacterial Viral Filter for CPAP/BIPAP/Vent Units **V** **P**

Item# **BF2200**
 22mm Bacteria
 Disk Filter
5/pack



Attach between the machine and tube for additional protection against bacteria and allergens

Filter Specifications

Bacterial Filtration Efficiency: (BFE) 99.99+%
 Viral Filtration Efficiency: (VFE) 99.9+%
 NaCl Particulate Filtration Efficiency: 96+%
 Flow Resistance: Approximately 8.8 mmH2O at 30 LPM
 Internal Volume: 66.3 mL without fittings / 78.3 mL with fittings

Connections:

- Patient End: 22 mm OD / 15 mm ID
- Machine End: 22 mm ID

Plastic Intake Filter with Head **V** **P**

Item# **BF017**
 For DeVilbiss Nebulizers
5/pack
 HCPCS# A7013



Foam Nebulizer Filter **V** **P**

Item# **BF018**
10/pack
 HCPCS# A7013



Plastic Intake Filter for Respironics InnoSpire **V** **P**

Item# **BF026S**
10/pack
 HCPCS# A7013



- Mini
- MicroElite
- MiniElite

EverFlo Intake Filter **V** **P**

Item# **BF1001**
Each
 Respironics OEM# 1038831

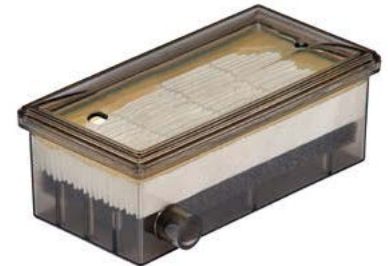

Bacterial/Viral HME Filter – Adult **V** **P**

Item# **BF104**
Each



- Bacterial efficiency 99.9999%
- Viral efficiency 99.999%
- Humidification efficiency 37.5 mg/l H2O (500 ml tidal volume)
- Coupled with a hydrophobic bacterial viral filter membrane

Filter for ResMed Astral Ventilator **V** **P**

Item# **VF003-4**
4/pack



Item# **VF003-H**
 Filter Housing
Each



Item# **VF003-KIT**
 4-Filter Kit
 w/Filter Housing
 OEM# 27939



Volumetric Incentive Spirometer V P

12/case

Item# **RES055**
2500ml

RES056
5000ml

RES055P
Pediatric



SCAN FOR VIDEO



- Chambers for ball and volumetric
- Tube
- Mouthpiece

The Volumetric Incentive Spirometer helps patients perform and monitor their own post-surgical breathing exercises. The patients are encouraged to breathe in from the device as slowly and as deeply as possible.

- Adjustable target indicator provides a volumetric guideline for adequate lung exercise
- Dual-sided, clear and legible identification of volumes
- Inspiratory indicator encourages patients to maintain an appropriate rate inspiration
- Compact and ergonomic design

Three Ball Spirometer

Item# **RES057-10** P
10/pack

RES057 V P
12/case

- Improves the patient's lung expansion by training their inhaled lung volume
- Three color coded balls inside the chamber offer incentive for the patient



- Three color-code balls in three chambers
- Chamber to lung capacity: 600cc/sec, 900cc/sec, and 1200cc/sec
- Compact design and break-resistant plastic
- Each set includes incentive spirometer, disposable mouth piece and flexible tube

Drainage Bag with Y-Adapter V P

Item# **RES071**
750cc
50/case



- Designed to ensure patients receive mist rather than liquid accumulated in the tubing
- Includes hanger and bottom drainage port
- Works with 22mm corrugated aerosol tubing

Drainage Bag with T-Adapter V P

Item# **RES070**
750cc
50/case



ResMed S9 and AirSense 10 Series Filters **V** **P**

Item# **CF2107**
 Disposable Filter
3/pack • 2 1/8" x 1 3/8"
 HCPCS# A7038
CF2107-1 1/pack OEM# 36850
CF2107-2 2/pack OEM# 36851
CF2107-50 50/pack OEM# 36853



Item# **CF2107HA**
 Hypoallergenic Filter
3/pack • 2 1/8" x 1 3/8"
 HCPCS# A7038
CF2107HA-1 1/pack OEM# 36855
CF2107HA-2 2/pack OEM# 36856
CF2107HA-50 50/pack
 OEM# 36858

ResMed AirSense 11 Series Filters **P**

Item# **CF2111**
 Disposable Filter
3/pack
 HCPCS# A7038
CF2111-1 1/pack OEM# 39300
CF2111-2 2/pack OEM# 39301
CF2111-50 50/pack OEM# 39303



Item# **CF2111HA-3**
 Hypoallergenic Filter
3/pack
 1 1/4" x 1 3/16"
 HCPCS# A7038
CF2111HA-1 1/pack
CF2111HA-2 2/pack

3B Luna G3 Style Filters **V** **P**

Item# **CF8006-6**
 Disposable Filter
6/pack
 HCPCS# A7038
CF8006-1 1/pack
CF8006-2 2/pack



Item# **CF8006F-1**
 Reusable Filter
1/pack
 HCPCS# A7039

3B Luna and Luna II Style Filters **P**

Item# **CF8005**
 Disposable Filter
12/pack • 2" x 1 3/16"
 HCPCS# A7038



Item# **CF8005F-1**
 Reusable Filter
1/pack • 2" x 1 3/16"
 HCPCS# A7039
CF8005F-2 2/pack

3B RESmart Style Filter **P**

Item# **CF8004**
 Disposable Filter
3/pack • 3 5/16" x 1 3/8"
 HCPCS# A7038



Respironics DreamStation 2 Series Filters V P



Item# **CF1012** Disposable Filter **6/pack**

OEM# 1142831
HCPCS# A7038

CF1012-1 1/pack OEM# 1142828

CF1012-2 2/pack OEM# 1142829

CF1012-3 3/pack

CF1012-50 50/pack



Item# **CF1012F** Reusable Filter **2/pack**

OEM# 1142687
HCPCS# A7039

CF1012F-1 1/pack



Respironics DreamStation Series Filters V P



Item# **CF1010** Disposable Filter **6/pack**

OEM# 1122519
HCPCS# A7038

CF1010-1 1/pack

CF1010-2 2/pack



Item# **CF1010F** Reusable Filter **2/pack**

OEM# 112446 (1-pack)
HCPCS# A7039

CF1010F-1 1/pack

CF1010F-6 6/pack



90-Degree CPAP Tubing Elbow V P

Item# **CAP1027** Each

The Sunset 90-Degree CPAP Tubing Elbow Adapter connects standard 22mm or slim 15mm CPAP tubes to most CPAP machines at a 90-degree angle, relieving stress on the tubing connection and creating a more convenient pathway to the bed.

Comparable to OEM# 37394



Color Coded Dual Channel Berman Oral Airway V P

50/pack

| Item# | Size | Color |
|--------------------|-------|--------|
| AOA40BC-50 | 40mm | Pink |
| AOA50BC-50 | 50mm | Blue |
| AOA60BC-50 | 60mm | Black |
| AOA70BC-50 | 70mm | White |
| AOA80BC-50 | 80mm | Green |
| AOA90BC-50 | 90mm | Yellow |
| AOA100BC-50 | 100mm | Red |
| AOA110BC-50 | 110mm | Orange |



- Smooth surface & rounded tip for improved patient comfort
- 100% Polyethylene (PE)
- Latex free

White Dual Channel Berman Oral Airway V P

10/pack

| Item# | Size |
|-----------------|-------|
| AOA40BD | 40mm |
| AOA60BD | 60mm |
| AOA80BD | 80mm |
| AOA90BD | 90mm |
| AOA100BD | 100mm |



Oropharyngeal Guedel Airway V P

10/pack

| Item# | Size | Color |
|------------------|-------|--------|
| AOP500GC | 50mm | Blue |
| AOP601GC | 60mm | Black |
| AOP702GC | 70mm | White |
| AOP803GC | 80mm | Green |
| AOP904GC | 90mm | Yellow |
| AOP1005GC | 100mm | Red |



- Designed to overcome associated risks of loose or detached bite blocks
- Smooth surface & rounded tip for improved patient comfort
- 100% Polyethylene (PE)
- Latex free

Nasopharyngeal Airway V

10/pack

| Item# | Size | Length |
|--------------------|------|--------|
| ANP1472PNE | 14fr | 72mm |
| ANP1685PNE | 16fr | 85mm |
| ANP18105PNE | 18fr | 105mm |
| ANP20115PNE | 20fr | 115mm |
| ANP22125PNE | 22fr | 125mm |
| ANP24130PNE | 24fr | 130mm |
| ANP26140PNE | 26fr | 140mm |
| ANP28155PNE | 28fr | 155mm |
| ANP30165PNE | 30fr | 165mm |
| ANP32170PNE | 32fr | 170mm |
| ANP34175PNE | 34fr | 175mm |



Tracheostomy Ties with Fastener Tabs V P

20/case

One-piece

- Easy on

Item#
RES029 Adult
RES029P Pediatric



- Designed to provide secure stabilization of the tracheostomy tube
- Made from soft foam and cotton

Two-piece

- Easy off

Item#
RES030 Adult
RES030P Pediatric

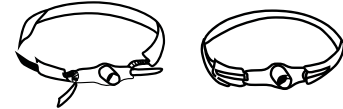

Tracheostomy Swivel Elbow Connectors V P

Item# **RES021**
With suction port
15mm ID x 15mm OD
10/pack



Endotracheal Tube Holders

20/case

Item#
TRAA005

Tube Holder

TRAA005B

Tube Holder with
Bite Block

Replaceable,
adjustable
neck strap

Moisture-resistant
upper lip retainer

Tube
runner

Soft protector
pads

Optional built-in
bite block

Tube
fastener

Sunset Trach Care Kits V Contract MS1486

50/case

Sunset Trach Care Kit

Item# **TRATK003**

Includes:

- 2 Gloves
- Drape
- 3 Pipe Cleaners
- Gauze
- 2 Cotton Tips
- Brush,
- Twill Tape
- Trach Dressing

Sunset Trach Care Kit
with Forceps

Item# **TRATK005**

Includes:

- 2 Gloves
- Drape
- 3 Pipe Cleaners
- 3 Gauze
- 3 Cotton Tips
- Brush
- Trach Dressing

Sunset Mini Trach Kit

Item# **TRATK004**

Includes:

- 3 Pipe Cleaners
- 4 Gauze
- 2 Cotton Tips
- Brush
- Twill Tape
- Dressing

Flex HME V P





Item# **RES027FLEX**
40/case



| | |
|-----------------------------------|-------------------------------|
| TV Range (mL) | 300-1500 |
| Moisture Output (mg H2O/L) | 33 mg/L |
| Weight (g) | 17 |
| Resistance (cm H2O) | 0.5 @ 30 LPM 1.34 @ 60 LPM |
| Dead Space (mL) | 75 |
| Connection (mm) | 22M,15F |

Heat Moisture Exchangers V P

30/case

| |  |  |  |  |  |
|-----------------------------------|---|---|--|---|---|
| Item# | RES027 T-HME | RES027OP T-HME with Oxygen Port | RES027IL Inline HME — Large Volume | RES027NE Inline HME — Neonatal | RES027HV2 Foam HME — Adult/Child |
| TV Range (mL) | 250-1000 | 150-1250 | 50-250 | 15-50 | 250-1000 |
| Moisture Output (mg H2O/L) | 30, Vt = 0.1L | 36.3 mg/L | 31, Vt = 0.1L | 30 | 29 |
| Weight (g) | 4.5 | 7.4 | 10 | 4.5 | 21 |
| Resistance (cm H2O) | 0.32 @ 30 LPM 0.81 @ 60 LPM 1.62 @ 90 LPM | 0.2 @ 30 LPM | 0.4 @ 10 LPM | 0.5 @ 10 LPM | 0.52 @ 30 LPM 1.32 @ 60 LPM 2.54 @ 90 LPM |
| Dead Space (mL) | 12.5 | 7 | 13 | 2.5 | 29 |
| Connection (mm) | 15F | 15F 5.5mm O2 port | 15M,22M/15F | 15M,15F | 22F/15M, 22M/15F |

Tracheostomy Mask with O₂ Connector V P

50/case

Item#
RES2130
Adult Regular Size

RES2130L
Adult Large Size

RES2230
Pediatric Size



- Latex-free
- 360° swivel in 2 places allows access from either side of the patient
- Comes with removable adapter to fit with aerosol or O₂ supply tubing

Adapter for T-HME

Item#
RES027A V P
Each
RES027A-30 30/pack P



Flexible Connector Length 4.9-7.5cm

50/case

Item#
TRAA004 V P
Adult — 22/15mm x 15mm

TRAA004P
Pediatric — 15mm F x 15mm M



Suction Catheter Kits P

50/case

| Size | Valve Type | Tip | Intended Use | Item# |
|------|------------|---------|--------------|-------------------|
| 5fr | Y | DeLee | Pediatric | TRATK305 |
| 6fr | Y | DeLee | Pediatric | TRATK306 |
| 8fr | Y | DeLee | Pediatric | TRATK308 |
| 8fr | Y | Whistle | Adult | TRATK108 |
| 8fr | Chimney | Whistle | Adult | TRATK108CV |
| 10fr | Y | Whistle | Adult | TRATK110 |
| 10fr | Chimney | Whistle | Adult | TRATK110CV |
| 12fr | Y | Whistle | Adult | TRATK112 |
| 12fr | Chimney | Whistle | Adult | TRATK112CV |
| 14fr | Y | Whistle | Adult | TRATK114 |
| 14fr | Chimney | Whistle | Adult | TRATK114CV |
| 16fr | Y | Whistle | Adult | TRATK116 |
| 16fr | Chimney | Whistle | Adult | TRATK116CV |

- Sterile
- Includes Catheter and Gloves

Mini Catheter Tray with Gloves V

50/case

| Item# | Catheter Size |
|---------------------|--------------------|
| TRATK310 | 10fr |
| TRATK312 | 12fr |
| TRATK312VCVN | 18fr, Vinyl Gloves |
| TRATK314 | 14fr |
| TRATK316 | 16fr |
| TRATK318 | 18fr |

- Coiled Catheter
- Calibrated

Sleeved Coiled Suction Catheter Kits with Cup V

50/case

| Item# | Catheter Size |
|-----------------|---------------|
| TRATK410 | 10fr |
| TRATK412 | 12fr |
| TRATK414 | 14fr |
| TRATK418 | 18fr |

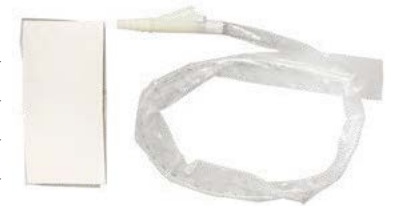

Suction Catheter Kits with Cup

50/case

| Size | Valve Type | Tip | Intended Use | Item# | Contract |
|------|------------|---------|--------------|-------------------|---|
| 5fr | Y | DeLee | Pediatric | TRATK405 | P |
| 6fr | Y | DeLee | Pediatric | TRATK406 | P |
| 6fr | Chimney | DeLee | Pediatric | TRATK206 | V |
| 8fr | Y | DeLee | Pediatric | TRATK408 | P |
| 8fr | Y | Whistle | Adult | TRATK208 | P V |
| 8fr | Chimney | Whistle | Adult | TRATK208CV | P |
| 10fr | Y | Whistle | Adult | TRATK210 | P V |
| 10fr | Chimney | Whistle | Adult | TRATK210CV | P |
| 12fr | Y | Whistle | Adult | TRATK212 | P V |
| 12fr | Chimney | Whistle | Adult | TRATK212CV | P |
| 14fr | Y | Whistle | Adult | TRATK214 | P V |
| 14fr | Chimney | Whistle | Adult | TRATK214CV | P |
| 16fr | Y | Whistle | Adult | TRATK216 | P |
| 16fr | Chimney | Whistle | Adult | TRATK216CV | P |
| 18fr | Y | Whistle | Adult | TRATK218 | V |



- Sterile
- Includes Catheter and Gloves

Suction Catheters

| Size | Valve | Tip | Intended Use | Packaged | Item# | Qty | Contract |
|------|---------|---------|--------------|----------|--------------------|-----|----------|
| 5fr | Y | DeLee | Pediatric | Coiled | TRASC305C | 50 | P |
| 5fr | Y | DeLee | Pediatric | Straight | TRASC305S | 100 | P |
| 6fr | Chimney | DeLee | Pediatric | Coiled | TRASC106C | 50 | V |
| 6fr | Y | DeLee | Pediatric | Coiled | TRASC306C | 50 | P |
| 6fr | Y | DeLee | Pediatric | Straight | TRASC306S | 100 | P |
| 8fr | Chimney | DeLee | Pediatric | Coiled | TRASC108C | 50 | V |
| 8fr | Chimney | DeLee | Pediatric | Straight | TRASC108S | 50 | V |
| 8fr | Y | DeLee | Pediatric | Coiled | TRASC308C | 50 | P |
| 8fr | Y | DeLee | Pediatric | Straight | TRASC308S | 100 | P |
| 10fr | Y | Whistle | Adult | Coiled | TRASC110C | 50 | P |
| 10fr | Y | Whistle | Adult | Straight | TRASC110S | 100 | P |
| 12fr | Y | Whistle | Adult | Coiled | TRASC112C | 50 | P |
| 12fr | Y | Whistle | Adult | Straight | TRASC112S | 100 | P |
| 14fr | Y | Whistle | Adult | Coiled | TRASC114C | 50 | P |
| 14fr | Chimney | Cloude | Adult | Straight | TRASC114CVS | 50 | V |
| 14fr | Y | Whistle | Adult | Straight | TRASC114S | 100 | P |
| 16fr | Y | Whistle | Adult | Coiled | TRASC116C | 50 | P V |
| 16fr | Y | Whistle | Adult | Straight | TRASC116S | 100 | P |
| 18fr | Y | Whistle | Adult | Coiled | TRASC118C | 50 | V |
| 18fr | Chimney | DeLee | Adult | Straight | TRASC118S | 50 | V |

- Sterile
- Single patient use
- Latex-free



Disposable Rigid Suction Canister

| Item# | Size | Direct to Regulator | Qty |
|------------------------|--------|---------------------|-----|
| RES023S-24 | 800cc | No | 24 |
| RES025AW1200R | 1200cc | Yes | 40 |
| RES025AW1200-40 | 1200cc | No | 40 |
| RES025AW2000 | 2000cc | No | 40 |
| RES025AW3000 | 3000cc | No | 40 |



- Prevents backflow and premature shut off.
- Includes 20-degree patient port for 1200cc, or straight port for 800c, to prevent tubing from kinking.
- Durability assurance for collecting and retaining aspirated fluids.
- Disposable.

Flexible Disposable Liner

50/case

| Item# | Size | Includes Solidifier |
|-------------------|--------|---------------------|
| LIN1000FD | 1000cc | No |
| LIN1500FD | 1500cc | No |
| LIN3000FD | 3000cc | No |
| LIN1000FDS | 1000cc | Yes |
| LIN1500FDS | 1500cc | Yes |
| LIN3000FDS | 3000cc | Yes |



- Part of a complete fluid management system.
- These soft, plastic liners fit into the reusable cannisters, creating less plastic waste and greater material utilization.
- Not made with natural rubber latex.

Reusable Outer Canister for Disposable Liner with Built In On/Off Valve

10/case

For Flexible Disposable Liner

| Item# | Size |
|-------------------|--------|
| LIN1000FDC | 1000cc |
| LIN1500FDC | 1500cc |
| LIN3000FDC | 3000cc |

For Semi-Rigid Disposable Liner

| Item# | Size |
|--------------------|--------|
| LIN1000SRDC | 1000cc |
| LIN1500SRDC | 1500cc |
| LIN3000SRDC | 3000cc |



- Reusable outer cannisters provide a safe, convenient, and economical solution for fluid collection.
- Clear plastic cannisters are designed to hold the disposable liners.
- Reusable polycarbonate canister/bracket assembly has pre-attached tubing for connection to the liner.

Semi-Rigid Disposable Liner

| Item# | Size |
|-------------------|--------|
| LIN1000SRD | 1000cc |
| LIN1500SRD | 1500cc |
| LIN3000SRD | 3000cc |

Canister/Liner Kits

| Item# | Size and Type | Tubing Size and Length | Qty |
|---------------------------|--|-------------------------------------|-----|
| LIN1000FD618 | 1000cc Flexible Liner | 6mm x 1.8m | 50 |
| LIN1000FD627 | 1000cc Flexible Liner | 6mm x 2.7m | 50 |
| LIN1500FD618 | 1500cc Flexible Liner | 6mm x 1.8m | 50 |
| LIN1500FD627 | 1500cc Flexible Liner | 6mm x 2.7m | 50 |
| LIN3000FD618 | 3000cc Flexible Liner | 6mm x 1.8m | 50 |
| LIN1000SRD618 | 1000cc Semi-Rigid Liner Kit | 6mm x 1.8m | 72 |
| LIN1000SRD627 | 1000cc Semi-Rigid Liner Kit | 6mm x 2.7m | 72 |
| LIN1500SRD518 | 1500cc Semi-Rigid Liner Kit | 5mm x 1.8m | 72 |
| LIN1500SRD618 | 1500cc Semi-Rigid Liner Kit | 6mm x 1.8m | 72 |
| LIN1500SRD627 | 1500cc Semi-Rigid Liner Kit | 6mm x 2.7m | 72 |
| LIN3000SRD618 | 3000cc Semi-Rigid Liner Kit | 6mm x 1.8m | 36 |
| RES023S-T | 800cc Disposable Suction Canister Kit | 6mm x 1.8m | 45 |
| RES025AW1200-T518 | 1200cc Disposable Suction Canister Kit | 5mm x 1.8m | 30 |
| RES025AW1200-T618 | 1200cc Disposable Suction Canister Kit | 6mm x 1.8m | 30 |
| RES025AW1200-T518V | 1200cc Disposable Suction Canister Kit | 5mm x 1.8m 5mm x .46m Vacuum Tubing | 30 |



Four-Canister Roll Stand

Item# **RES9100**
30"
Each



Wall Plate

Item# **RES9101**
10/case



Disposable Suction Canister Ring Bracket

20/case

| Item# | Size |
|----------------|-------------|
| RES9102 | 1200cc |
| RES9103 | 2000-3000cc |

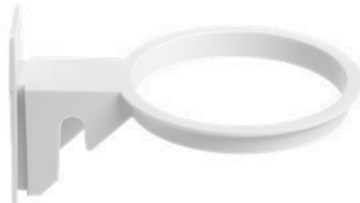

Disposable Suction Canister Ring Bracket

20/case

| Item# | Size |
|-----------------|--------|
| RES9102T | 1200cc |
| RES9103T | 2000cc |



Disposable Suction Canister Ring Bracket Extended for Regulator with DISS

20/case

| Item# | Size |
|-----------------|-------------|
| RES9102D | 1200cc |
| RES9103D | 2000-3000cc |



Disposable Suction Canister Ring Bracket with On/Off Valve

20/case

| Item# | Size |
|-----------------|-------------|
| RES9102V | 1200cc |
| RES9103V | 2000-3000cc |

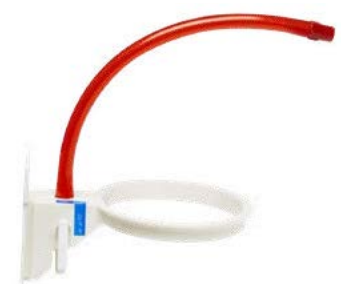

Semi-Rigid Suction Canister Ring Bracket Close to Wall

Each

| Item# | Size |
|----------------|--------|
| RES9104 | 1000cc |
| RES9105 | 1500cc |



Semi-Rigid Suction Canister Ring Bracket Extended For Regulator

Item# **RES9105E**
1500cc
Each



Suction Tubing — Single Use Sterile

50/case

| Item# | Diameter | Length |
|----------------------|------------------|-------------|
| RES025-31618 | 5mm | 46cm (18in) |
| RES025-31672 | 5mm | 1.8m (6ft) |
| RES025-316120 | 5mm | 3.0m (10ft) |
| RES025-316144 | 5mm | 3.7m (12ft) |
| RES025-316240 | 5mm | 6.1m (20ft) |
| RES025-14072 | 6mm | 1.8m (6ft) |
| RES025-14120 | 6mm | 3.0m (10ft) |
| RES025-14144 | 6mm | 3.7m (12ft) |
| RES025-14240 | 6mm | 6.1m (20ft) |
| RES025-93272 | 7mm | 1.8m (6ft) |
| RES025-932120 | 7mm | 3.0m (10ft) |
| RES025-932144 | 7mm | 3.7m (12ft) |
| RES025-932240 | 7mm | 6.1m (20ft) |
| RES025-38120 | Large Bore 9.5mm | 3.0m (10ft) |



Yankauer — Single Use Sterile

100/case

| Item# | Tip | Vented |
|-----------------|----------|--------|
| TRAA002S | Bulbous | No |
| TRAA001S | Bulbous | Yes |
| TRAA004S | Straight | No |
| TRAA003S | Straight | Yes |

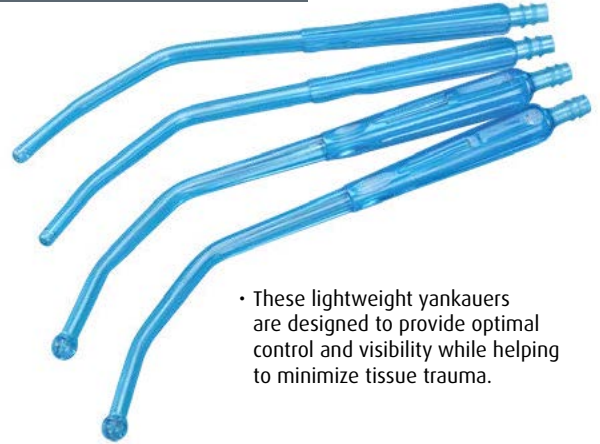

• These lightweight yankauers are designed to provide optimal control and visibility while helping to minimize tissue trauma.

Bulk Roll — Non-Sterile

4/case

| Item# | Diameter | Length |
|--------------------|----------|--------|
| RES025B-530 | 5mm | 30m |
| RES025B-630 | 6mm | 30m |
| RES025B-730 | 7mm | 30m |

- Clear bulk tubing in rolls that can be cut into the exact length needed.
- Cut-to-size female connectors are located at 6ft intervals.
- Disposable accessories make it easy to add auxiliary items to your system.
- Flex Advantage liners, Guardian systems, Medi-Vac accessories are interchangeable to help you select the most effective setup for your needs.
- Allows you to adapt your system for various setups.
- Used to connect vacuum source to canisters and manifolds.

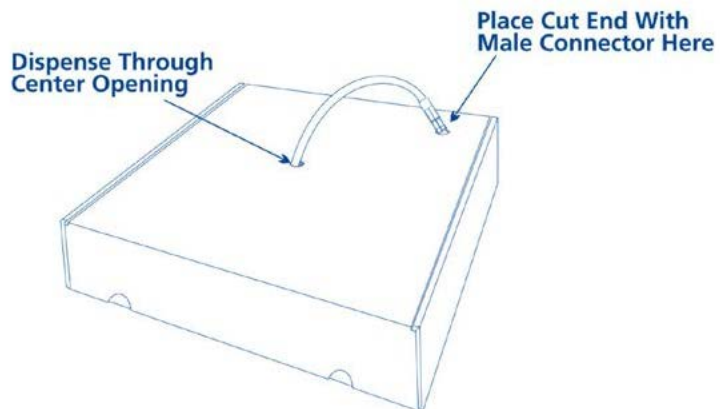
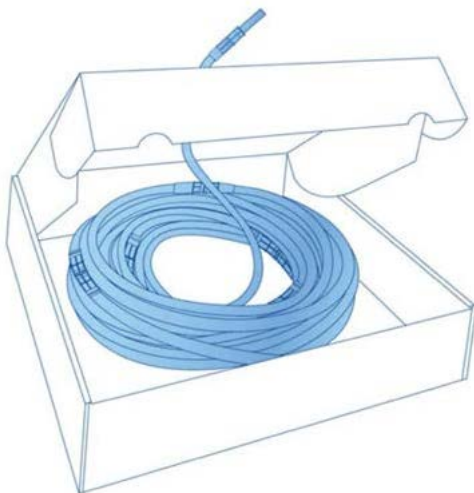

Solidifier — Dissolvable Sachet

100/case

| Item# | Size |
|----------------|--------|
| RES8001 | 150cc |
| RES8004 | 450cc |
| RES8015 | 1500cc |



Economical

Pre-measured rupturing pouches eliminate the tearing and spillage associated with conventional solidifiers for medical waste.

Particulate-Free

Self-activating technology reduces particulates and bacterial exposure, and eliminates harmful dust.

Reduce Exposure

Helps to minimize the risk of cross contamination of infectious waste to medical staff.

Solidifier with Treatment — Dissolvable Sachet

100/case

| Item# | Size |
|-----------------|--------|
| RES8002T | 250cc |
| RES8005T | 500cc |
| RES8007T | 750cc |
| RES8015T | 1500cc |



Contain spills quickly with this astonishingly absorbent liquid solidifier packet

Super absorbent packets quickly absorb up to 400 times their own weight in aqueous solutions. These drop-in liquid absorbers offer the ideal solution for shipping, storing, and handling of aqueous solutions that must be contained quickly and effectively in the event of a leak.

Smart Design

Specially formulated pouch bursts open in the presence of a wide range of fluids to quickly immobilize them. Solidified material is easily contained by an outer vessel, shipping container, or other such device, resulting in safer handling.

Ideal for Medical Use

The most common applications for the use include medical shipping containers and bio-specimen transportation bags used for vials, test kits, and lab trays.

SperaChamber V P

Anti-Static Valved Inhaler Chamber for Metered Dose Inhaler

Item# **RES195-10**
10/case

- Inhalation valve
- Universal adapter
- Spiral vents
- Seal with exhalation safety valve
- Latex-free and DEHP-free

Item# **RES195-50**
50/case



SperaChamber with Mask
10/case

| Item# | Size |
|-----------------|--------------------|
| RES195MS | Small (Infant) |
| RES195MM | Medium (Pediatric) |
| RES195ML | Large (Adult) |

Mask Only

| Item# | Size | Qty |
|------------------------|--------------------|---------------|
| RES195MASK-S | Small (Infant) | Each |
| RES195MASK-S-10 | Small (Infant) | 10/box |
| RES195MASK-M | Medium (Pediatric) | Each |
| RES195MASK-M-10 | Medium (Pediatric) | 10/box |
| RES195MASK-L | Large (Adult) | Each |
| RES195MASK-L-10 | Large (Adult) | 10/box |

Peak Flow Meter V P

Item# **RES052**
10/case

50-800 L/min

- High performance
- Quality controlled
- Color areas indicator
- Slip design
- One-way valve
- Latex-free
- Phthalate-free



Item# **RES052MPD** V P
 Pediatric Mouthpiece for Peak Flow Meter
10/case

Plastic Intake Filter with Head V P
For Respironics Inspiration 626 & 929

Item# **BF016**
10/pack



Valved T-Adapter, Aerosol V P

Item# **NEB9001T**
 22mm ID x 22mm OD
10/case



Valved T-Adapter — Adult V P

Item# **VEN001**
 22F-18F-22M/15F
Each Premier
10/pack Vizient



Compressor Nebulizers V P

Item# NEB100

- Disposable Nebulizer Kit with Angled Mouthpiece (RES096)
- Foam Filters (BF018 x5)

NEB100-R

- Disposable Nebulizer Kit with Angled Mouthpiece (RES096)
- Reusable T-Piece Kit (RES093)
- Foam Filters (BF018 x5)



Sunny the Bear

Item# **NEB300BEAR**



Gordon the Fish

Item# **NEB300FISH**



SCAN FOR VIDEO



NEB100-BAG V P
Carry Bag

- Rust-resistant
- Quiet (below 60dBA)
- 6ml medication capacity
- Average nebulization rate above 0.2ml/min
- Particle size: respirable fraction 0.5 to 5um 0.5um 80%
- Compressor pressure range 30-45 PSI
- Operation pressure range 12-14 PSI
- Liter flow range 8-10 LPM

Handheld Compressor Nebulizer V P

Item# NEB200

Included:

- Compressor
- Medication cup
- AC power adapter
- Air hose
- Elbow
- Mouthpiece
- Mask
- 4 AA batteries

- Runs on 4 AA batteries or AC power adapter
- Portable (small and weighs only 1/2 pound)
- Quiet (60dBA)
- Fine particle size (Approximately 3 microns)
- No replacement filter required



Mini Mesh Nebulizer with Rechargeable Battery V P

Item# NEB401

Included:

- Main unit
- Medicine cup
- Disposable mouthpiece
- Disposable adult mask
- Disposable pediatric mask
- USB cord
- Carrying bag
- Instruction manual



Small particle size
MMAD 2.2µm*

Efficient
Low Residual Liquid

Convenient
Small and Portable

Quiet
≤50dB (at one meter)

Modern
Rechargeable Lithium Battery

Disposable Nebulizer Kit

Item#
RES090 V P

Adult Size

50/case

- 6cc jet nebulizer bottle
- Mask
- 7ft supply tube

RES090A V P

No Accessories

50/case

RES090NM P

- 6cc jet nebulizer bottle
- 7ft supply tube

50/case

RES092 V P

Pediatric Size

50/case

- Pediatric aerosol mask
- 6cc jet nebulizer bottle
- 7ft supply tube



Disposable Nebulizer Kit with T-Piece V P

Item#
RES091

Disposable
 Single Patient

50/case

RES091U

Disposable
 Single Patient,
 Universal Connector

50/case

RES091NA

Disposable
 Single Patient,
 No Aerosol

50/case

HCPCS# A7003

- Green, convex cone is easy to see and remove for simple cleaning and reassembly

- Easy to read medication jar provides a leak-proof seal



Includes:

- 6cc jet nebulizer bottle
- T-piece with mouthpiece and corrugated reservoir tube
- 7ft supply tube

Reusable Nebulizer Kit with T-Piece P

Item# **RES093**

Reusable — Single Patient

10/case

HCPCS# A7005

Includes:

- 10cc jet nebulizer bottle
- T-piece with mouthpiece and corrugated reservoir tube
- 7ft supply tube
- Latex-free
- Dishwasher safe
- High capacity (10cc)
- CC volume markings
- Very low residual volume (0.7cc)
- 1/4 turn cap provides leakproof seal
- Works upright or at angles up to 45°



Disposable Nebulizer Kit with Angled Mouthpiece V P

Item#

RES096

Disposable
 Single Patient

50/case

HCPCS# A7003

RES096U

Disposable Single Patient,
 Universal Connector

50/case

Includes:

- 6cc jet nebulizer bottle
- Angled mouthpiece
- 7ft supply tube



Aerosol Mask

50/case

Item#

RES2110 V P

Adult Size

RES2110F P

Adult Size
 w/ Flex Tube

RES2210 V P

Pediatric Size

- Clear, soft vinyl for patient comfort
- Adjustable nose clip for secure seal
- Connector accepts 22mm aerosol tubing
- Individually packaged



Closed Ventilation Suction System

Standard Switch

Sterile and latex-free

ISO color coded for instant recognition of catheter sizes.

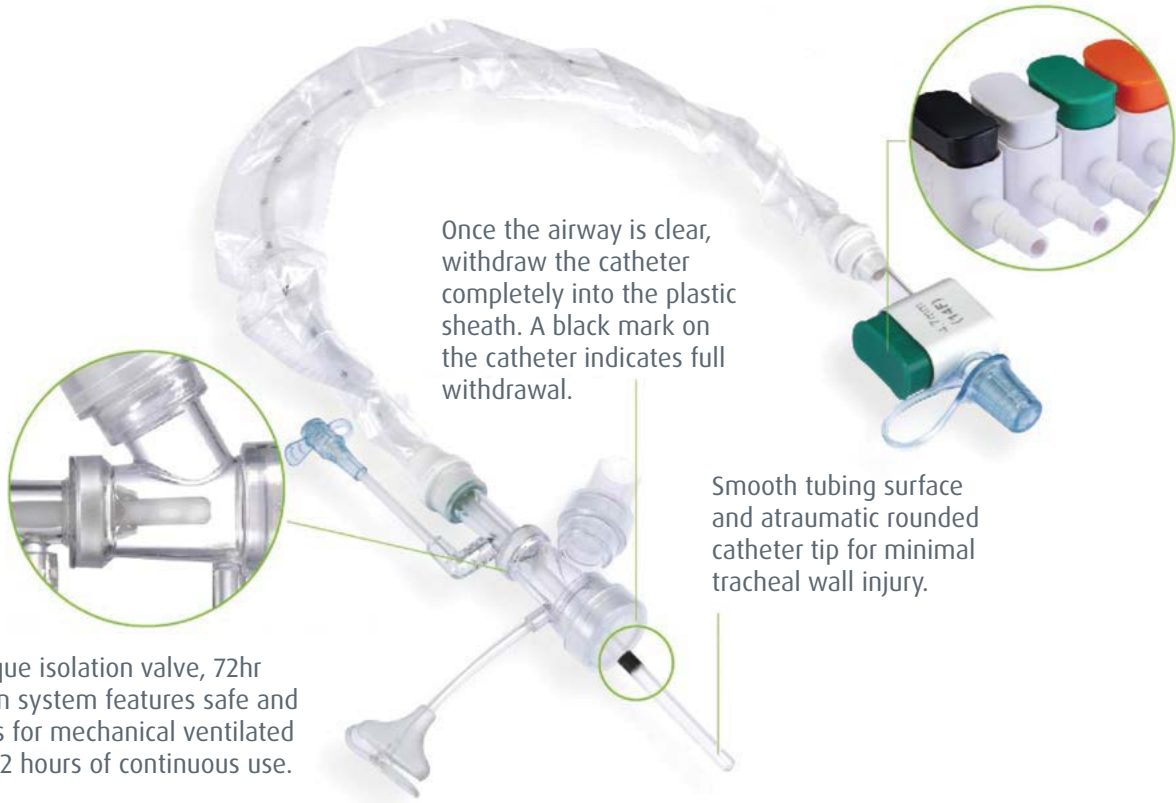

Once the airway is clear, withdraw the catheter completely into the plastic sheath. A black mark on the catheter indicates full withdrawal.

Smooth tubing surface and atraumatic rounded catheter tip for minimal tracheal wall injury.

With the unique isolation valve, 72hr closed suction system features safe and simple access for mechanical ventilated patients for 72 hours of continuous use.

Closed Ventilation Suction System **V**

Standard Switch

Sterile and latex-free

24 Hour Adult

Endotracheal 530mm With Swivel Connector

| Item# | Description |
|--------------|----------------|
| VEN72453010M | 10Fr, MDI Port |
| VEN72453012M | 12Fr, MDI Port |
| VEN72453016M | 16Fr, MDI Port |

Endotracheal 530mm With T-Piece

| Item# | Description |
|--------------|----------------|
| VEN82453010M | 10Fr, MDI Port |
| VEN82453012M | 12Fr, MDI Port |
| VEN82453014M | 14Fr, MDI Port |
| VEN82453016M | 16Fr, MDI Port |

Tracheostomy With Swivel Connector

| Item# | Description |
|--------------|-----------------------|
| VEN72430510M | 305mm, 10Fr, MDI Port |
| VEN72430512M | 305mm, 12Fr, MDI Port |
| VEN72430514M | 305mm, 14Fr, MDI Port |
| VEN72430516M | 305mm, 16Fr, MDI Port |

Tracheostomy With T-Piece

| Item# | Description |
|--------------|-----------------------|
| VEN82430510M | 305mm, 10Fr, MDI Port |
| VEN82430512 | 305mm, 12Fr |
| VEN82430512M | 305mm, 12Fr, MDI Port |
| VEN82430514 | 305mm, 14Fr |
| VEN82430514M | 305mm, 14Fr, MDI Port |
| VEN82430516 | 305mm, 16Fr |
| VEN82430516M | 305mm, 16Fr, MDI Port |
| VEN82440512M | 405mm, 12Fr, MDI Port |
| VEN82440514M | 405mm, 14Fr, MDI Port |
| VEN82440516M | 405mm, 16Fr, MDI Port |

72 Hour Adult

Endotracheal 530mm With Swivel Connector

| Item# | Description |
|--------------|----------------|
| VEN77253010M | 10Fr, MDI Port |
| VEN77253012M | 12Fr, MDI Port |
| VEN77253014M | 14Fr, MDI Port |
| VEN77253016M | 16Fr, MDI Port |

Tracheostomy 305mm With Swivel Connector

| Item# | Description |
|--------------|----------------|
| VEN77230510M | 10Fr, MDI Port |
| VEN77230512M | 12Fr, MDI Port |
| VEN77230514M | 14Fr, MDI Port |
| VEN77230516M | 16Fr, MDI Port |

72 Hour Neonatal/Pediatric

With Swivel Connector

| Item# | Description |
|-------------|-------------|
| VEN77230505 | 305mm, 5Fr |
| VEN77230506 | 305mm, 6Fr |
| VEN77230507 | 305mm, 7Fr |
| VEN77230508 | 305mm, 8Fr |



24 Hour Neonatal/Pediatric

With Y-Adapter

| Item# | Description |
|--------------|-----------------------|
| VEN66000500 | 305mm, 5Fr |
| VEN66000500M | 305mm, 5Fr, MDI Port |
| VEN66000600 | 305mm, 6Fr |
| VEN66000600M | 305mm, 6Fr, MDI Port |
| VEN66000700 | 305mm, 7Fr |
| VEN66000700M | 305mm, 7Fr, MDI Port |
| VEN66000800 | 305mm, 8Fr |
| VEN66000800M | 305mm, 8Fr, MDI Port |
| VEN66001000 | 405mm, 10Fr |
| VEN66001000M | 405mm, 10Fr, MDI Port |

With Swivel Connector

| Item# | Description |
|-------------|-------------|
| VEN72430505 | 305mm, 5Fr |
| VEN72430506 | 305mm, 6Fr |
| VEN72430507 | 305mm, 7Fr |
| VEN72430508 | 305mm, 8Fr |

Closed Ventilation Suction System

Deluxe Switch (one-handed operation)

Sterile and latex-free

Suction Control Switch

Ergonomic suction control switch with a built-in security lock to visually determine if the device is in the OFF/ON position. Offers a quick and easy, single-handed operation design, which allows you to keep your eye on the patient and do no harm. One-handed operation allows the free hand to support the ET or Trach device to ensure less trauma to the site.

Irrigation Port

Offers a one-way valve to prevent backflow leakage and easy access for cleaning the closed suction system.

MDI Port

Provides access for drug delivery as needed. Large and easy to grip port allows for rapid medication introduction.

Catheter Tip

Atraumatic rounded catheter tip for minimal tracheal wall injury.

Isolation Valve*

Seals the irrigation chamber to provide a better cleaning of the catheter. Allows for continuous ventilation and prevents backflow of saline during cleaning to ensure patient comfort and safety.

*Only available with 72 Hour catheter

Black Ring Indicator

Ensures that the catheter is properly withdrawn from the ET or Trach device. Black ring must be visible in the plastic sheath after suctioning the patient.

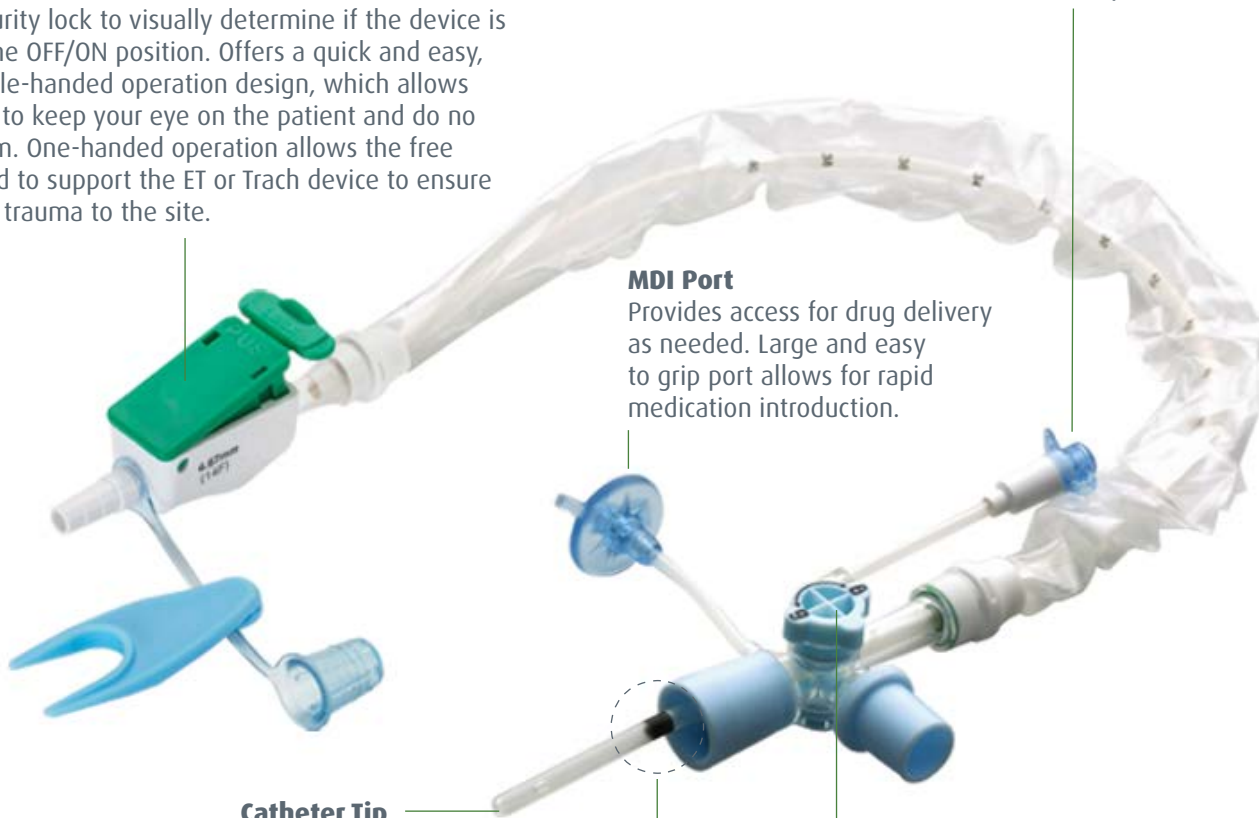

Closed Ventilation Suction System V

Deluxe Switch (One-handed operation)

Sterile and latex-free

24 Hour Adult

Endotracheal 540mm

| Item# | Description |
|-------------|---------------------------------|
| VEN160100A | 10Fr |
| VEN160100AM | 10Fr, MDI Port |
| VEN162100A | 10Fr, Wedge + Adapter |
| VEN162100AM | 10Fr, MDI Port, Wedge + Adapter |
| VEN160120 | 12Fr |
| VEN160120M | 12Fr, MDI Port |
| VEN162120 | 12Fr, Wedge + Adapter |
| VEN162120M | 12Fr, MDI Port, Wedge + Adapter |
| VEN160140 | 14Fr |
| VEN160140M | 14Fr, MDI Port |
| VEN162140 | 14Fr, Wedge + Adapter |
| VEN162140M | 14Fr, MDI Port, Wedge + Adapter |
| VEN160160 | 16Fr |
| VEN160160M | 16Fr, MDI Port |
| VEN162160 | 16Fr, Wedge + Adapter |
| VEN162160M | 16Fr, MDI Port, Wedge + Adapter |

Tracheostomy 305mm

| Item# | Description |
|-------------|---------------------------------|
| VEN161100A | 10Fr |
| VEN161100AM | 10Fr, MDI Port |
| VEN163100A | 10Fr, Wedge + Adapter |
| VEN163100AM | 10Fr, MDI Port, Wedge + Adapter |
| VEN161120 | 12Fr |
| VEN163120 | 12Fr, Wedge + Adapter |
| VEN161140 | 14Fr |
| VEN163140 | 14Fr, Wedge + Adapter |
| VEN161160 | 16Fr |
| VEN161160M | 16Fr, MDI Port |
| VEN163160 | 16Fr, Wedge + Adapter |

72 Hour Adult

Endotracheal 540mm

| Item# | Description |
|-------------|---------------------------------|
| VEN365100A | 10Fr |
| VEN365100AM | 10Fr, MDI Port |
| VEN367100A | 10Fr, Wedge + Adapter |
| VEN367100AM | 10Fr, MDI Port, Wedge + Adapter |
| VEN365120 | 12Fr |
| VEN365120M | 12Fr, MDI Port |
| VEN367120 | 12Fr, Wedge + Adapter |
| VEN367120M | 12Fr, MDI Port, Wedge + Adapter |
| VEN365140 | 14Fr |
| VEN365140M | 14Fr, MDI Port |
| VEN367140M | 14Fr, Wedge + Adapter |
| VEN365160 | 16Fr |
| VEN365160M | 16Fr, MDI Port |
| VEN367160 | 16Fr, Wedge + Adapter |
| VEN367160M | 16Fr, MDI Port, Wedge + Adapter |

Tracheostomy 305mm

| Item# | Description |
|-------------|---------------------------------|
| VEN366100A | 10Fr |
| VEN366100AM | 10Fr, MDI Port |
| VEN368100A | 10Fr, Wedge + Adapter |
| VEN368100AM | 10Fr, MDI Port, Wedge + Adapter |
| VEN366120 | 12Fr |
| VEN366120M | 12Fr, MDI Port |
| VEN368120 | 12Fr, Wedge + Adapter |
| VEN368120M | 12Fr, MDI Port, Wedge + Adapter |
| VEN366140 | 14Fr |
| VEN366140M | 14Fr, MDI Port |
| VEN368140 | 14Fr, Wedge + Adapter |
| VEN368140M | 14Fr, MDI Port, Wedge + Adapter |
| VEN366160 | 16Fr |
| VEN366160M | 16Fr, MDI Port |
| VEN368160 | 16Fr, Wedge + Adapter |
| VEN368160M | 16Fr, MDI Port, Wedge + Adapter |

Neonatal/Pediatric

| Item# | Description |
|--------------|-----------------------|
| VEN26000500 | 305mm, 5Fr |
| VEN26000500M | 305mm, 5Fr, MDI Port |
| VEN26000600 | 305mm, 6Fr |
| VEN26000600M | 305mm, 6Fr, MDI Port |
| VEN26000700 | 305mm, 7Fr |
| VEN26000700M | 305mm, 7Fr, MDI Port |
| VEN26000800 | 305mm, 8Fr |
| VEN26000800M | 305mm, 8Fr, MDI Port |
| VEN26001000 | 405mm, 10Fr |
| VEN26001000M | 405mm, 10Fr, MDI Port |



Swivel Straight Connector V

Item#
VEN005-20

Disposable
22mm ID, 15mm OD
20/pack



Adult Resuscitator P

12/case

| Item# | Pop-Off | Mask |
|-----------------|---------|------|
| RES8100 | No | None |
| RES8100H | Yes | None |
| RES8101 | Yes | #4 |
| RES8102 | Yes | #5 |



Child Resuscitator P

12/case

| Item# | Pop-Off | Mask |
|-----------------|---------|------|
| RES8110H | Yes | None |
| RES8111 | Yes | #2 |
| RES8112 | Yes | #3 |



Infant Resuscitator P

12/case

| Item# | Pop-Off | Mask |
|-----------------|---------|------|
| RES8120H | Yes | None |
| RES8121 | Yes | #0 |
| RES8122 | Yes | #1 |



- Single patient use
- Set includes PVC reservoir bag, PVC mask, and disposable oxygen tubing
- 100% Medical grade PVC material
- Latex-free components
- All-in-one intake valve connects to oxygen reservoir bag directly
- Diverter is able to attach PEEP valve

Disposable Pressure Manometer **P**

Item# **RES8201**
25/case



- Pressure range 0-60 cm H2O
- Indicator strip
- All models have the pressure range emboss printed on the housing
- Some users like to also have a color strip / indicator

Disposable Pressure Manometer, L-Shaped **P**

Item# **RES8201L**
25/case



- Pressure range 0-60 cm H2O
- Indicator strip
- All models have the pressure range emboss printed on the housing
- Some users like to also have a color strip / indicator

Reusable PEEP Valve, Orange **P**

2-10cm H2O
10/case

Item#
RES8203R
15mm ID



RES8203RL
30mm ID

- Available in orange color in 2-10cm H2O and blue color in 5-20cm H2O types with choice of 30mm or 15mm ID
- Adjustable from 0-20cm water pressure
- Materials: Polycarbonate, silicone, stainless steel for spring

Reusable PEEP Valve, Blue **P**

5-20cm H2O
10/case

Item#
RES8204B
15mm ID



RES8204BL
30mm ID

- Available in orange color in 2-10cm H2O and blue color in 5-20cm H2O types with choice of 30mm or 15mm ID
- Adjustable from 0-20cm water pressure
- Materials: Polycarbonate, silicone, stainless steel for spring

Disposable PEEP Valve, Orange **P**

2.5-10cm H2O
10/case

Item#
RES8205R
15mm ID



RES8205RL
30mm ID

- Available in 2.5-10cm H2O and 5-20cm H2O types with choice of 30mm or 15mm ID
- Adjustable from 0-20cm water pressure
- Single patient use
- Materials: Polycarbonate, silicone, stainless steel

Disposable PEEP Valve, Blue **P**

5-20cm H2O
10/case

Item#
RES8205B
15mm ID



RES8205BL
30mm ID

- Available in 2.5-10cm H2O and 5-20cm H2O types with choice of 30mm or 15mm ID
- Adjustable from 0-20cm water pressure
- Single patient use
- Materials: Polycarbonate, silicone, stainless steel

Reservoir Bag, PVC P

25/case

| Item# | Size |
|-----------------|------|
| RES8300P | 0.5L |
| RES8301P | 1L |
| RES8302P | 2L |



Reservoir Bag, Silicone P

25/case

| Item# | Size |
|-----------------|------|
| RES8300S | 0.5L |
| RES8301S | 1L |
| RES8302S | 2L |



Suitable for reusable resuscitator.

CPR Pocket Resuscitator Set P

Item# **RES8200**

12/case

- High transparency for better visualization
- Non-reusable, single use only
- 100% Medical level PVC material
- Latex-free components
- Economical choice
- Blow molding



Breathing Mask P

20/case

| Item# | Size | Hooks |
|----------------|------------------------|-------|
| SBC01N | Neonatal (#0) | No |
| SBC01I | Infant (#1) | No |
| SBC01P | Pediatric (#2) | No |
| SBC01S | Adult Small (#3) | No |
| SBC01M | Adult Medium (#4) | No |
| SBC01L | Adult Large (#5) | No |
| SBC01XL | Adult Extra Large (#6) | No |
| SBC02N | Neonatal (#0) | Yes |
| SBC02I | Infant (#1) | Yes |
| SBC02P | Pediatric (#2) | Yes |
| SBC02S | Adult Small (#3) | Yes |
| SBC02M | Adult Medium (#4) | Yes |
| SBC02L | Adult Large (#5) | Yes |
| SBC02XL | Adult Extra Large (#6) | Yes |



Silicone Disposable Laryngeal Masks P

| Item# | Size |
|----------------|------|
| ALM1001 | #1 |
| ALM1015 | #1.5 |
| ALM1002 | #2 |
| ALM1025 | #2.5 |
| ALM1003 | #3 |
| ALM1004 | #4 |
| ALM1005 | #5 |

- Medical grade silicone for super compatibility and patient comfort
- No epiglottis bars for easy insertion of fiberoptic scope, introducers and suction catheters
- Available with seven sizes for all patient use



Silicone Reusable Laryngeal Masks P

| Item# | Size |
|-----------------|------|
| ALM1001R | #1 |
| ALM1015R | #1.5 |
| ALM1002R | #2 |
| ALM1025R | #2.5 |
| ALM1003R | #3 |
| ALM1004R | #4 |
| ALM1005R | #5 |

- Reusable Silicone Laryngeal Masks are designed to be sterilized and used up to 40 times
- Durable high temperature resistant material suitable for autoclave sterilization
- Serial no. is printed on each connector for easy tracking
- Additional user card for record of device usage times and patient information is supplied in each pouch



Flexible Silicone Disposable Laryngeal Masks P

| Item# | Size |
|----------------|------|
| ALM3001 | #1 |
| ALM3015 | #1.5 |
| ALM3002 | #2 |
| ALM3025 | #2.5 |
| ALM3003 | #3 |
| ALM3004 | #4 |
| ALM3005 | #5 |

- Flexible Laryngeal Mask is specially designed for use in ophthalmic, ENT, dental, oro-maxillary, and other head and neck surgeries
- Wire reinforced tube reduces risk of kinking and airway tube occlusion
- Flexible tube allows for placement away from surgical field and improves surgical access while maintaining good airtightness



Flexible Silicone Reusable Laryngeal Masks P

| Item# | Size |
|-----------------|------|
| ALM3001R | #1 |
| ALM3015R | #1.5 |
| ALM3002R | #2 |
| ALM3025R | #2.5 |
| ALM3003R | #3 |
| ALM3004R | #4 |
| ALM3005R | #5 |

- Flexible Laryngeal Mask is specially designed for use in ophthalmic, ENT, dental, oro-maxillary, and other head and neck surgeries
- Wire reinforced tube reduces risk of kinking and airway tube occlusion
- Flexible tube allows for placement away from surgical field and improves surgical access while maintaining good airtightness



PVC Disposable Laryngeal Masks **P**

| Item# | Size |
|----------------|------|
| ALM2001 | #1 |
| ALM2015 | #1.5 |
| ALM2002 | #2 |
| ALM2025 | #2.5 |
| ALM2003 | #3 |
| ALM2004 | #4 |
| ALM2005 | #5 |

- Medical grade PVC with good compatibility
- No epiglottis bars for easy insertion of fiberoptic scope, introducers and suction catheters



Flexible PVC Disposable Laryngeal Masks **P**

| Item# | Size |
|----------------|------|
| ALM4001 | #1 |
| ALM4015 | #1.5 |
| ALM4002 | #2 |
| ALM4025 | #2.5 |
| ALM4003 | #3 |
| ALM4004 | #4 |
| ALM4005 | #5 |

- Medical grade PVC with good compatibility
- No epiglottis bars for easy insertion of fiberoptic scope, introducers and suction catheters



| Size | Patient Weight and Age | |
|------|------------------------|-----------|
| #1 | Up to 5 kg | Pediatric |
| #1.5 | 5-10 kg | Pediatric |
| #2 | 10-20 kg | Pediatric |
| #2.5 | 20-30 kg | Pediatric |
| #3 | 30-50 kg | Pediatric |
| #4 | 50-70 kg | Adult |
| #5 | 70-100 kg | Adult |

PeDIA - Pediatric Device for Induction of Anesthesia V P

Item#

ANEP021Y

With Mask Adapter Elbow

12/pack



2025 Innovation Celebration Winner

Use with
mask



Or use
without
mask



Turn panic into play

For children, undergoing surgery is already unsettling, and the process of induction is often the most traumatizing part. Often kids will kick and scream, believing they're being trapped by the gas or suffocated by the mask. The experiences create negative emotional scarring that can last weeks, months or even years.

Specially designed for children undergoing surgery, the Pediatric Device for Induction of Anesthesia device, or "PeDIA," for short, includes a colorful whistling balloon, providing kids with something fun to focus on and turning a stressful moment into a lighter one.

Whether they're squeezing the balloon and focusing on its whistle or directly putting themselves to sleep by breathing the gas through balloon delivery, the PeDIA balloon captivates children's attention, allowing their active participation in the induction process.

It's a simple way to add a brighter touch to the medical experience, ease anxiety and bring smiles to patients, parents and staff.

This unique approach—presenting an interactive, familiar toy-like device—not only diverts children's focus from the impending procedure but also significantly reduces the anxiety and resistance commonly associated with mask induction. The aim is to decrease the anxiety felt by over 50% of pediatrics as well as parents and staff.

The PeDIA can be used alone as a mask-free device or, for younger children, with an anesthesia mask.

SCAN FOR VIDEOS

